

20.30.1016.01

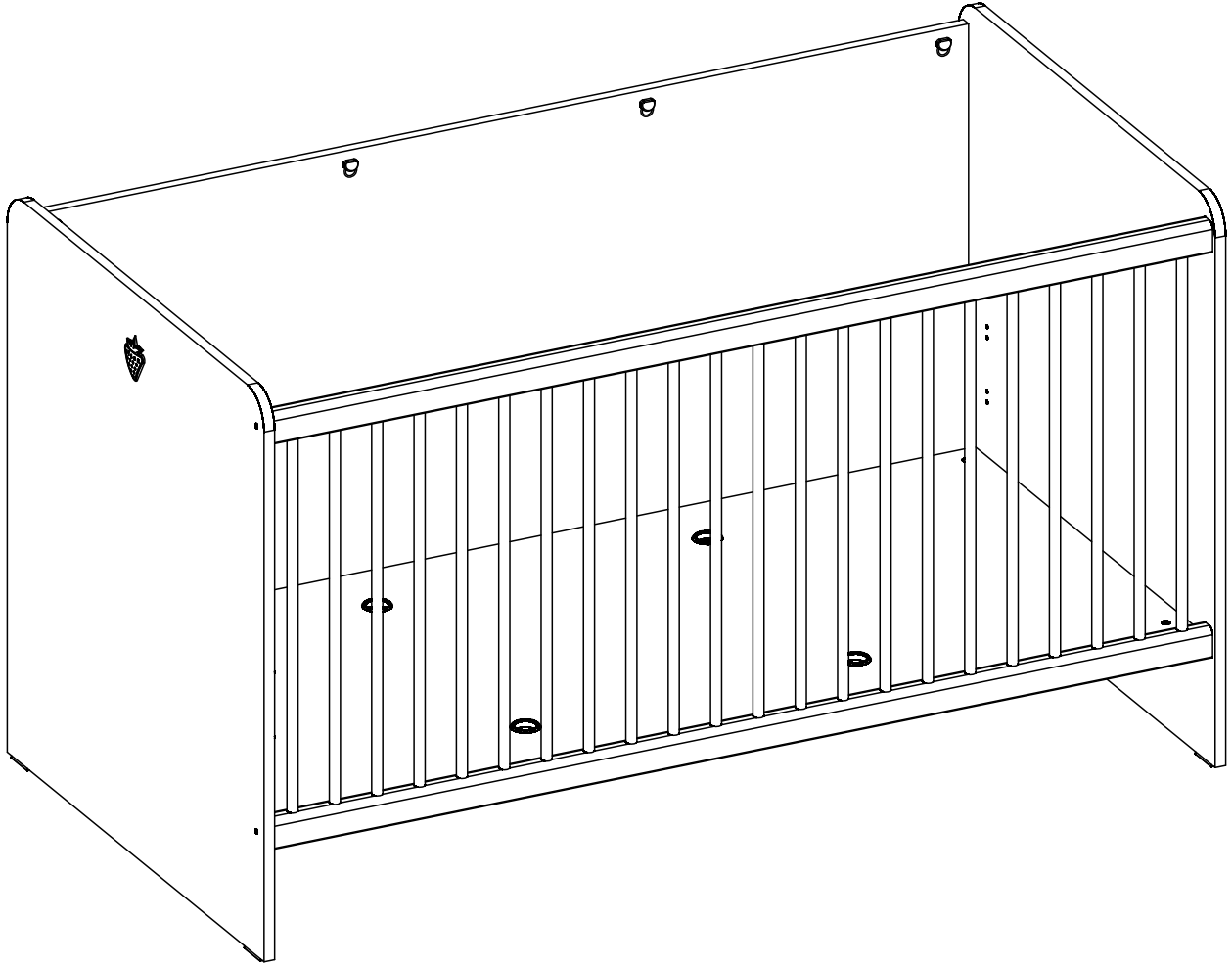

GARANTİ BELGESİ VE
KULLANMA KILAVUZU



WARRANTY CERTIFICATE
AND USER MANUAL

شهادة الضمان ودليل المستخدم



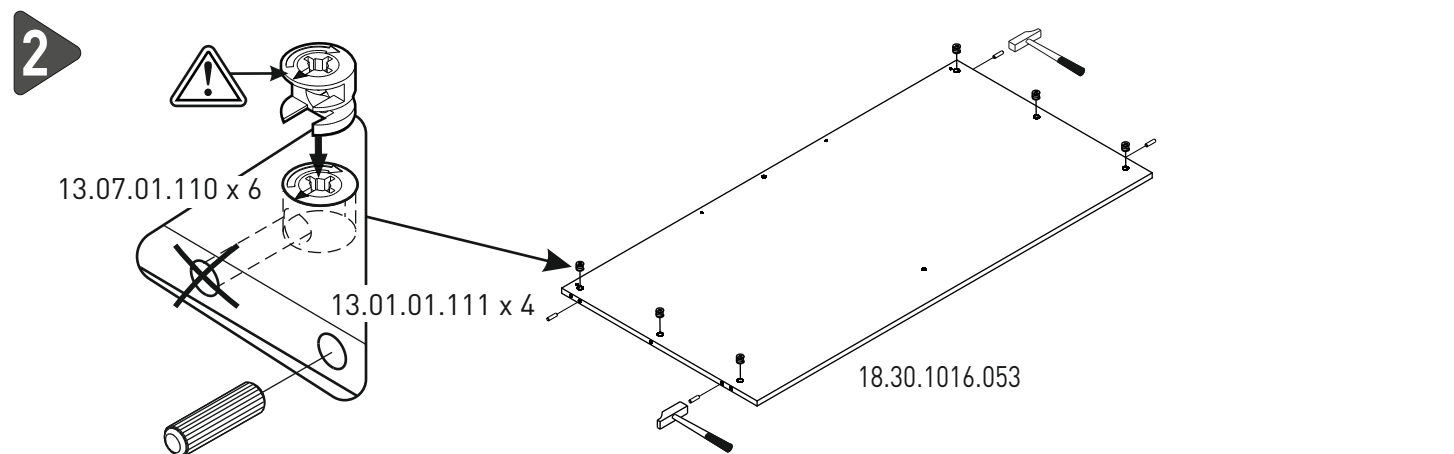
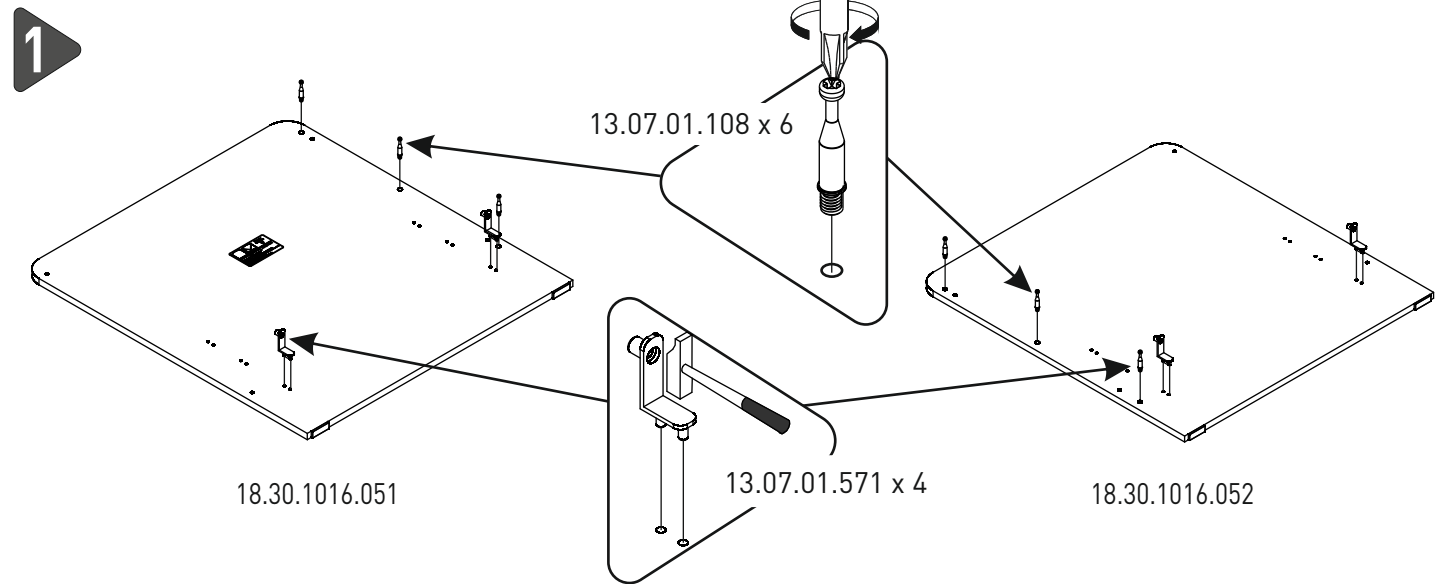
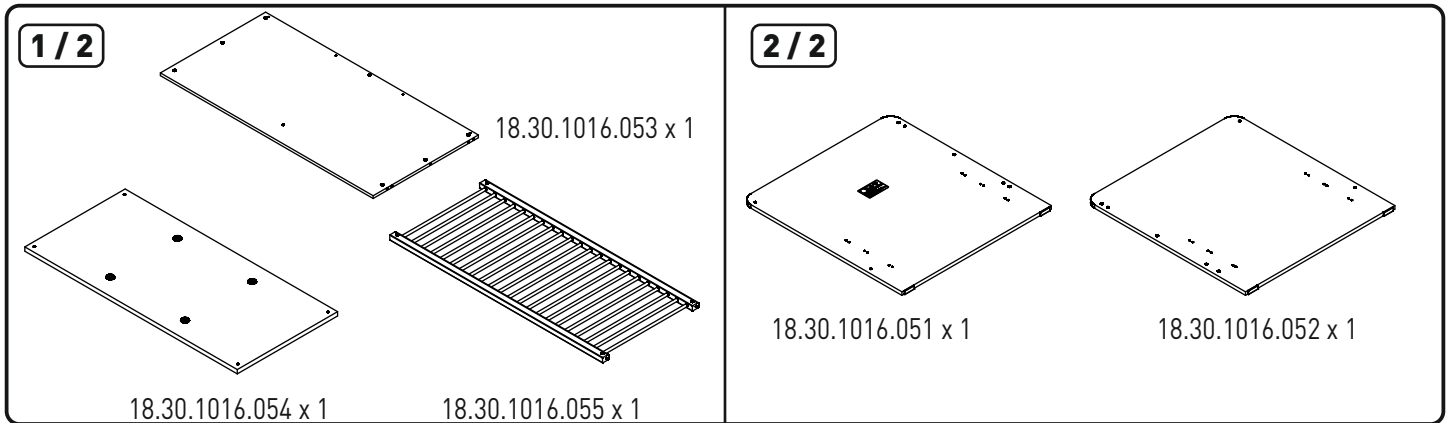
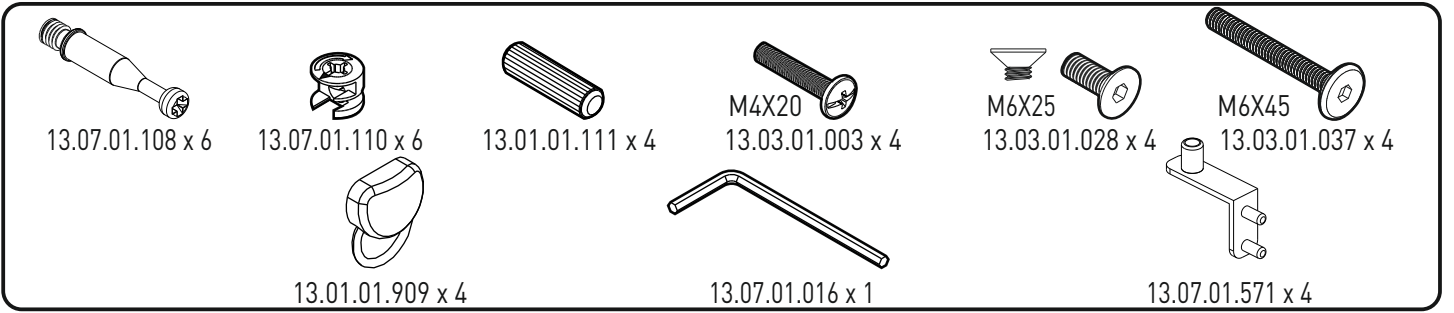
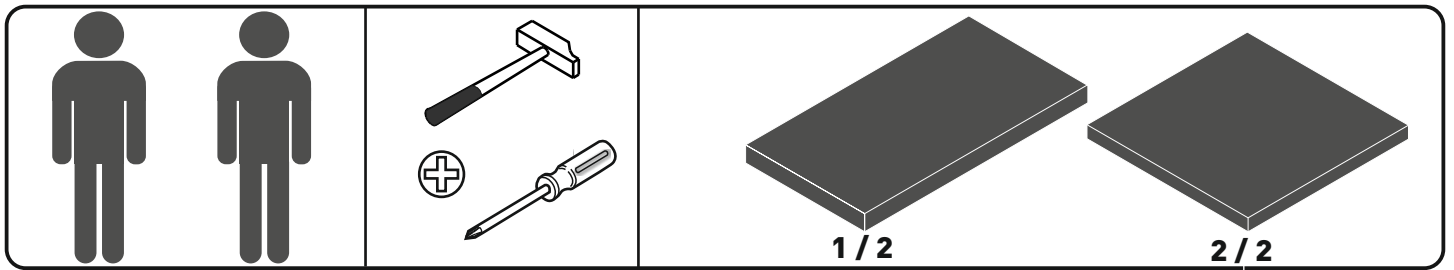

3

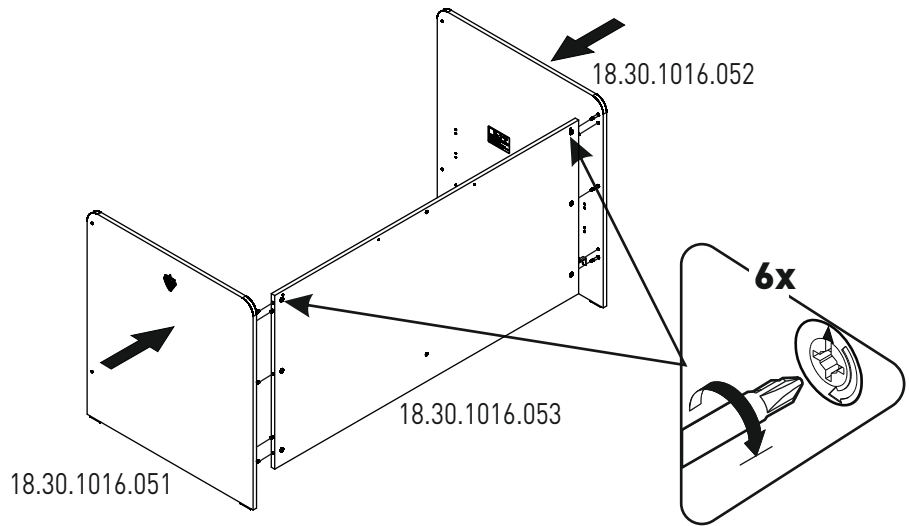

4

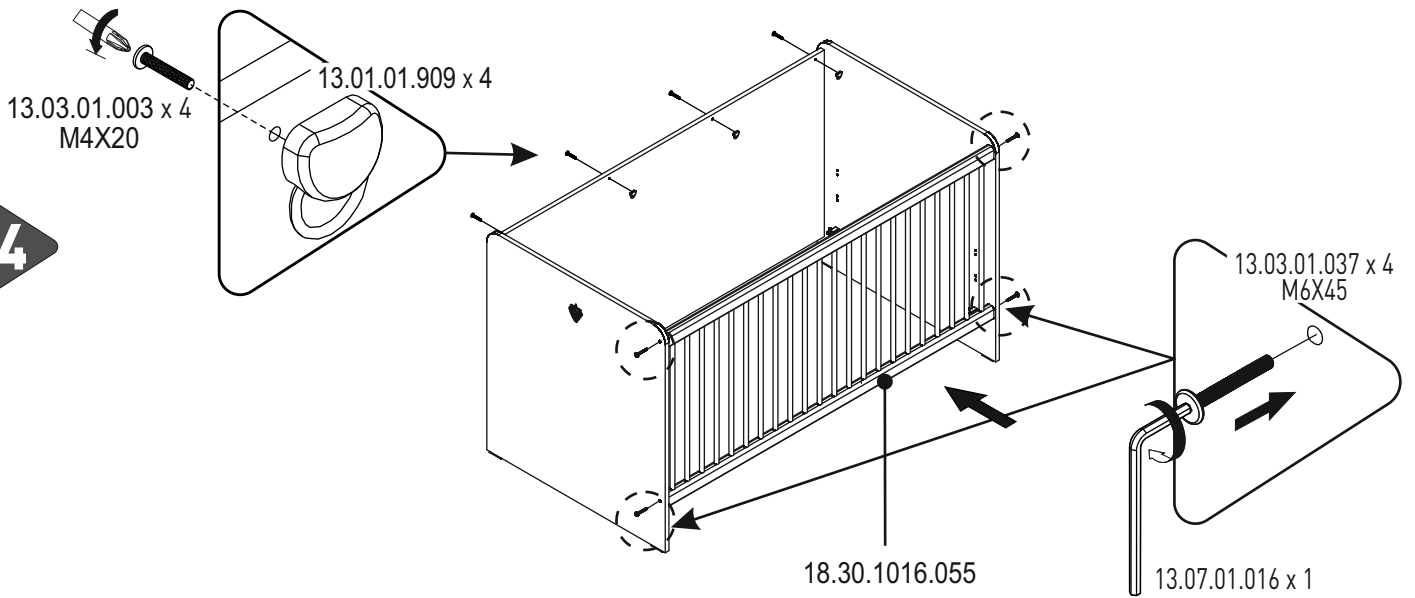

5

