

# 20.77.1317.00

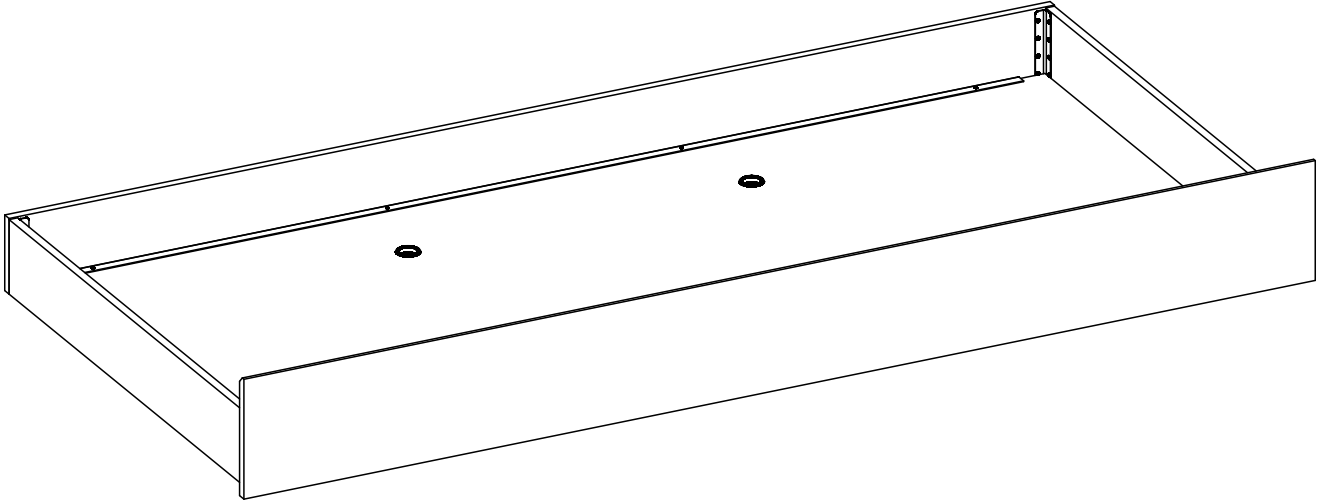

GARANTİ BELGESİ VE  
KULLANMA KILAVUZU



WARRANTY CERTIFICATE  
AND USER MANUAL

شهادة الضمان ودليل المستخدم



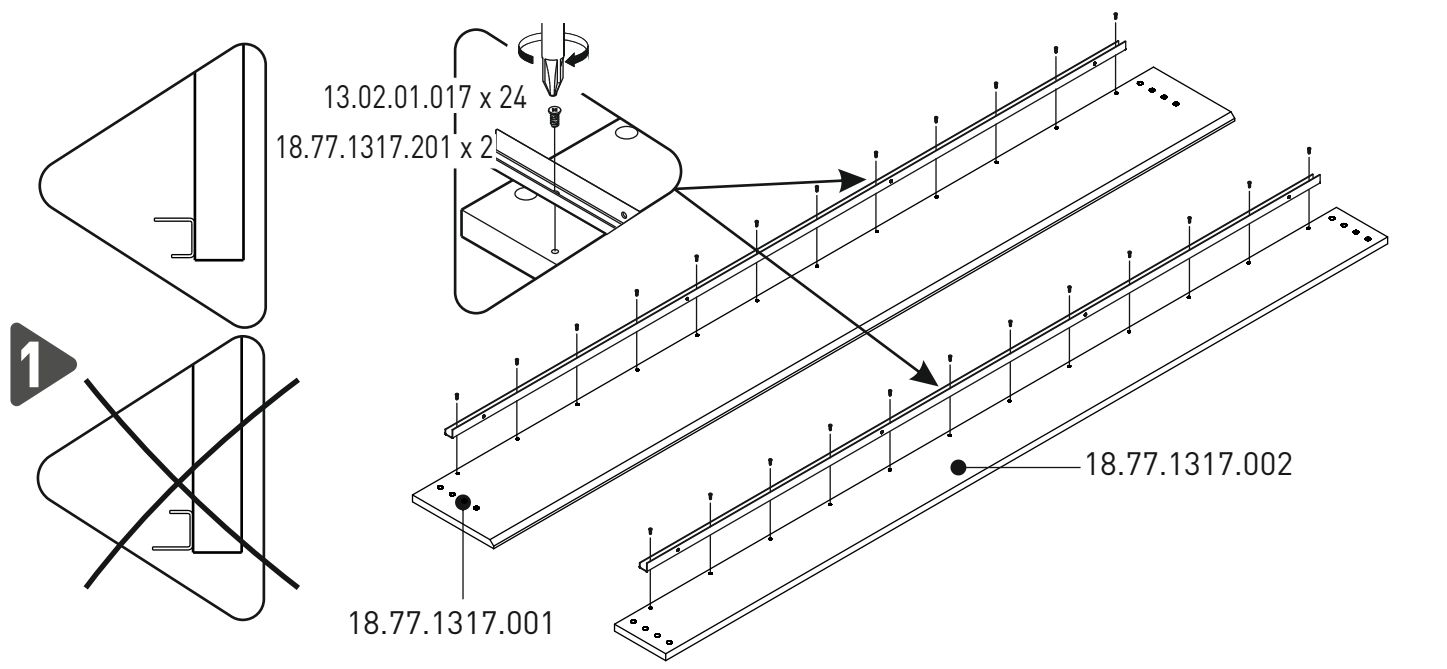
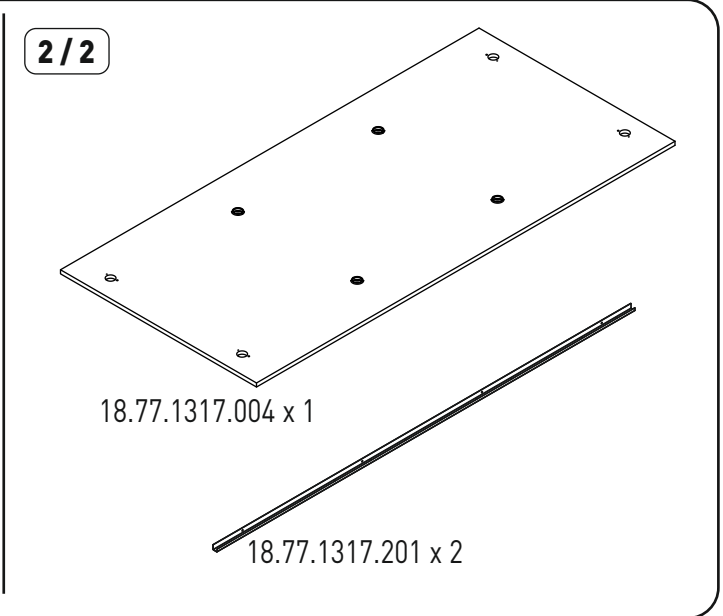
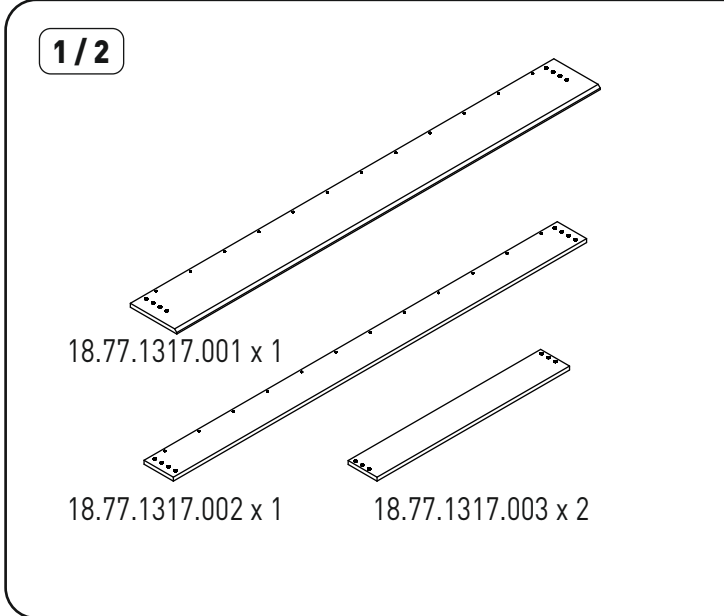
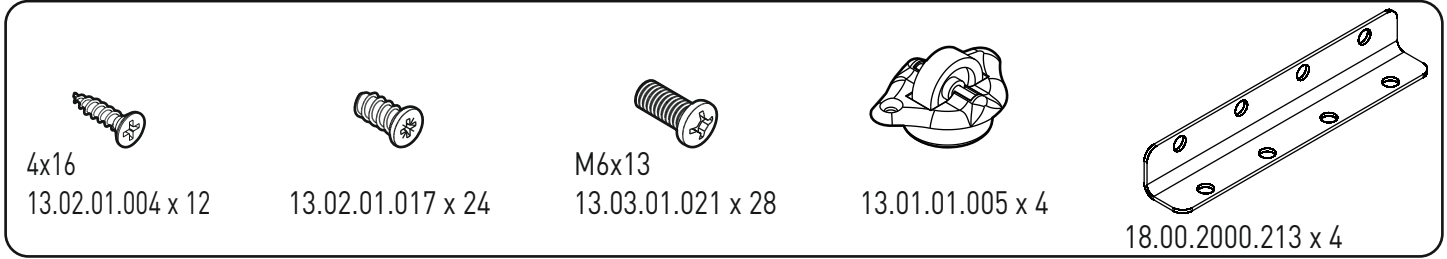
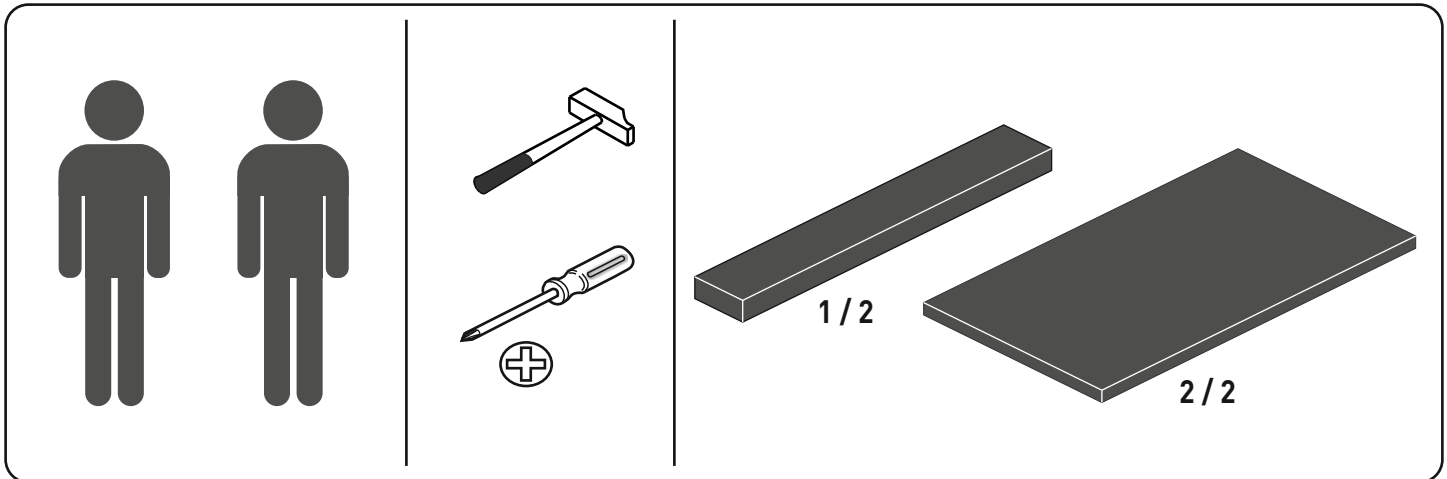

2

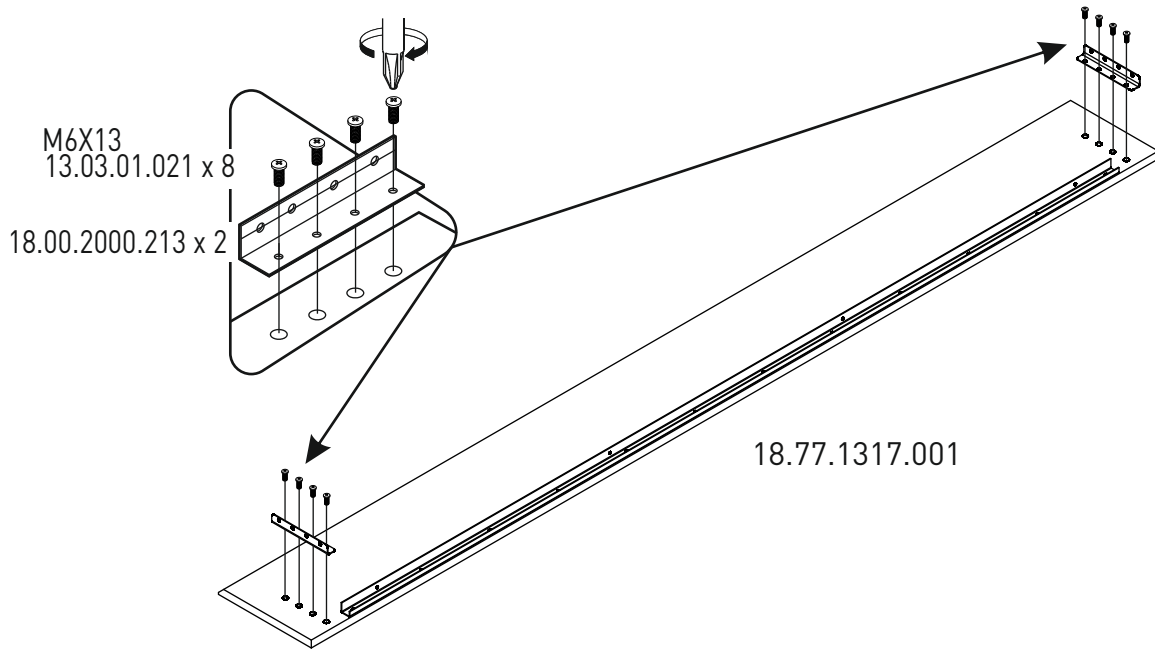

3

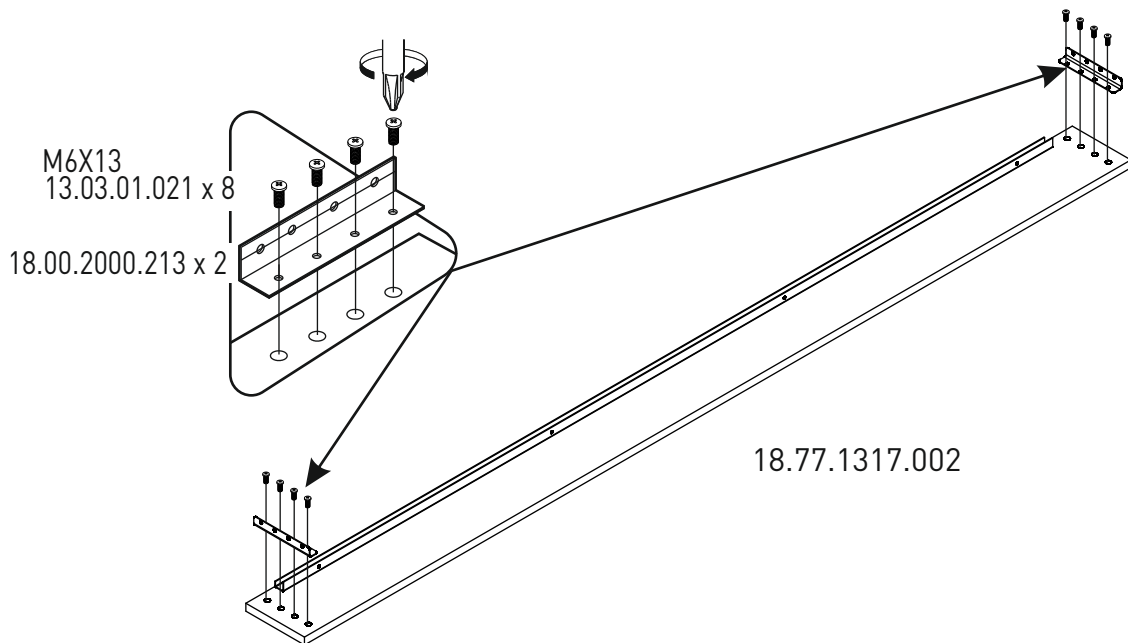

4

