

20.78.1702.00

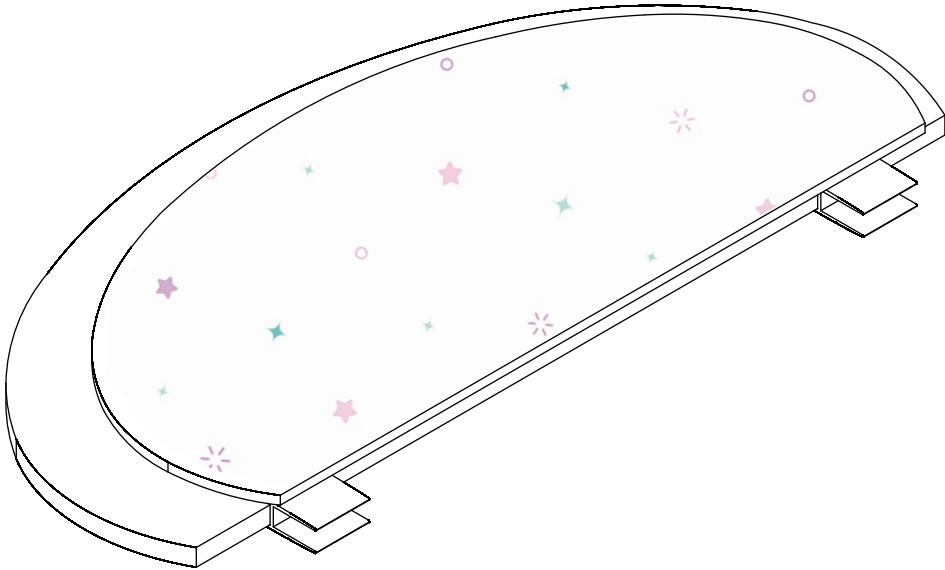

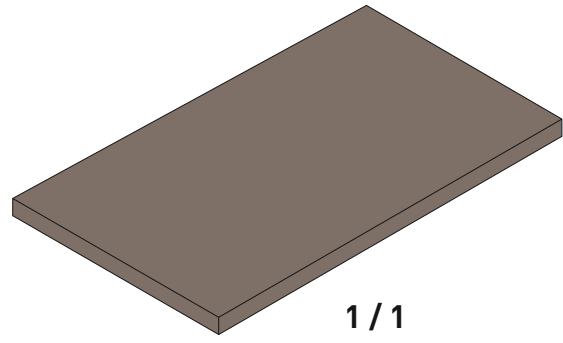
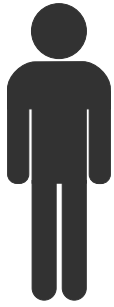

1 / 1

1 / 1

