

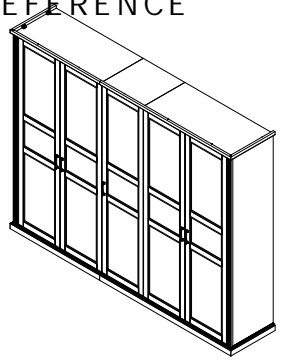

IMPORTANT - READ CAREFULLY - RETAIN FOR FUTURE REFERENCE
 WICHTIG - SORGFÄLTIG LESEN UND AUFBEWAHREN

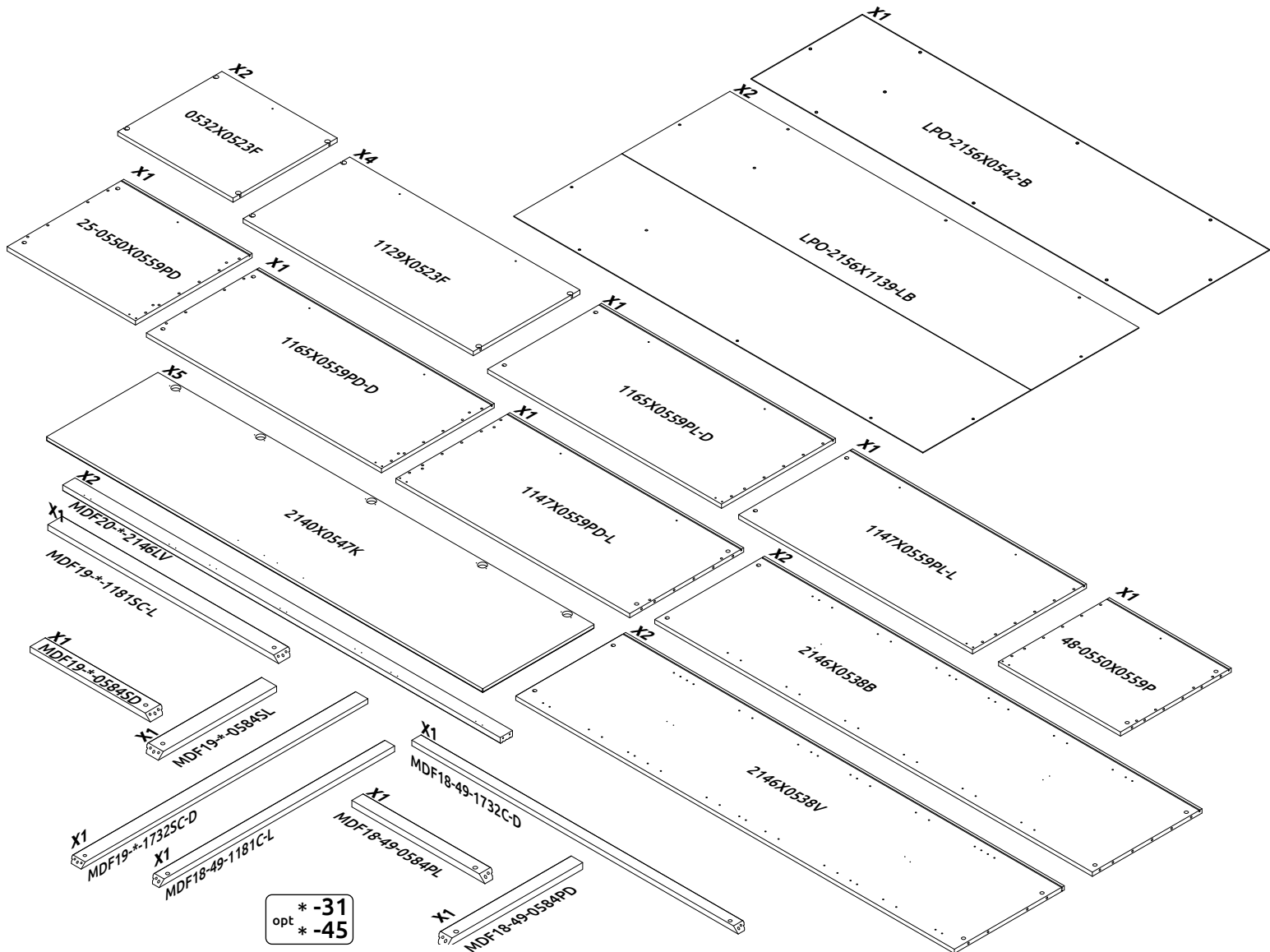

P5/TA
 LHW - 2912x2271x584

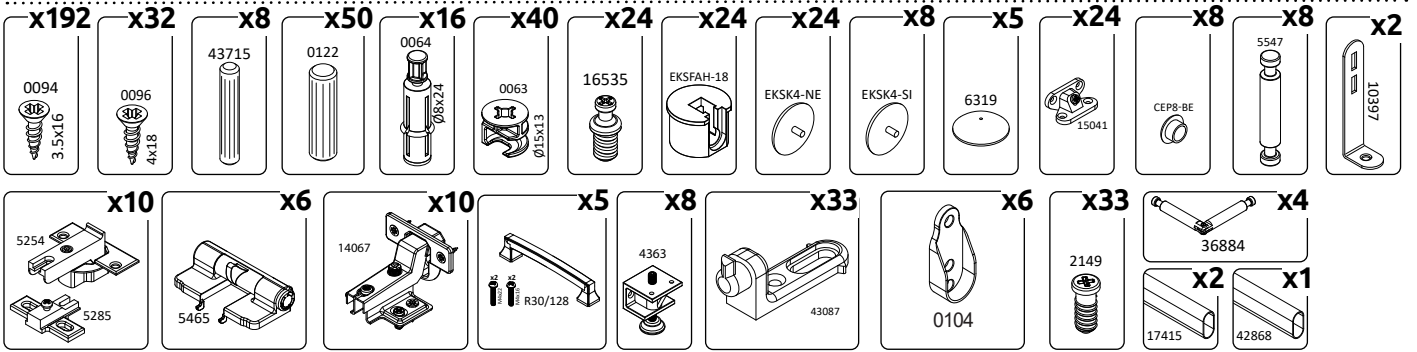
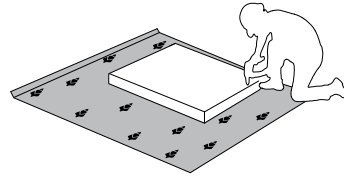
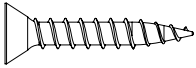
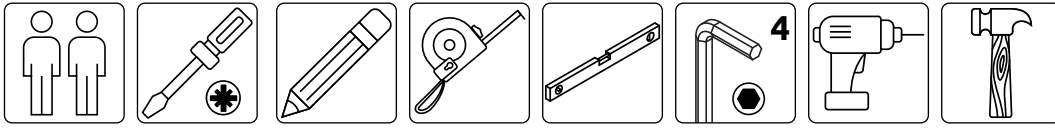

* -31
 opt * -45

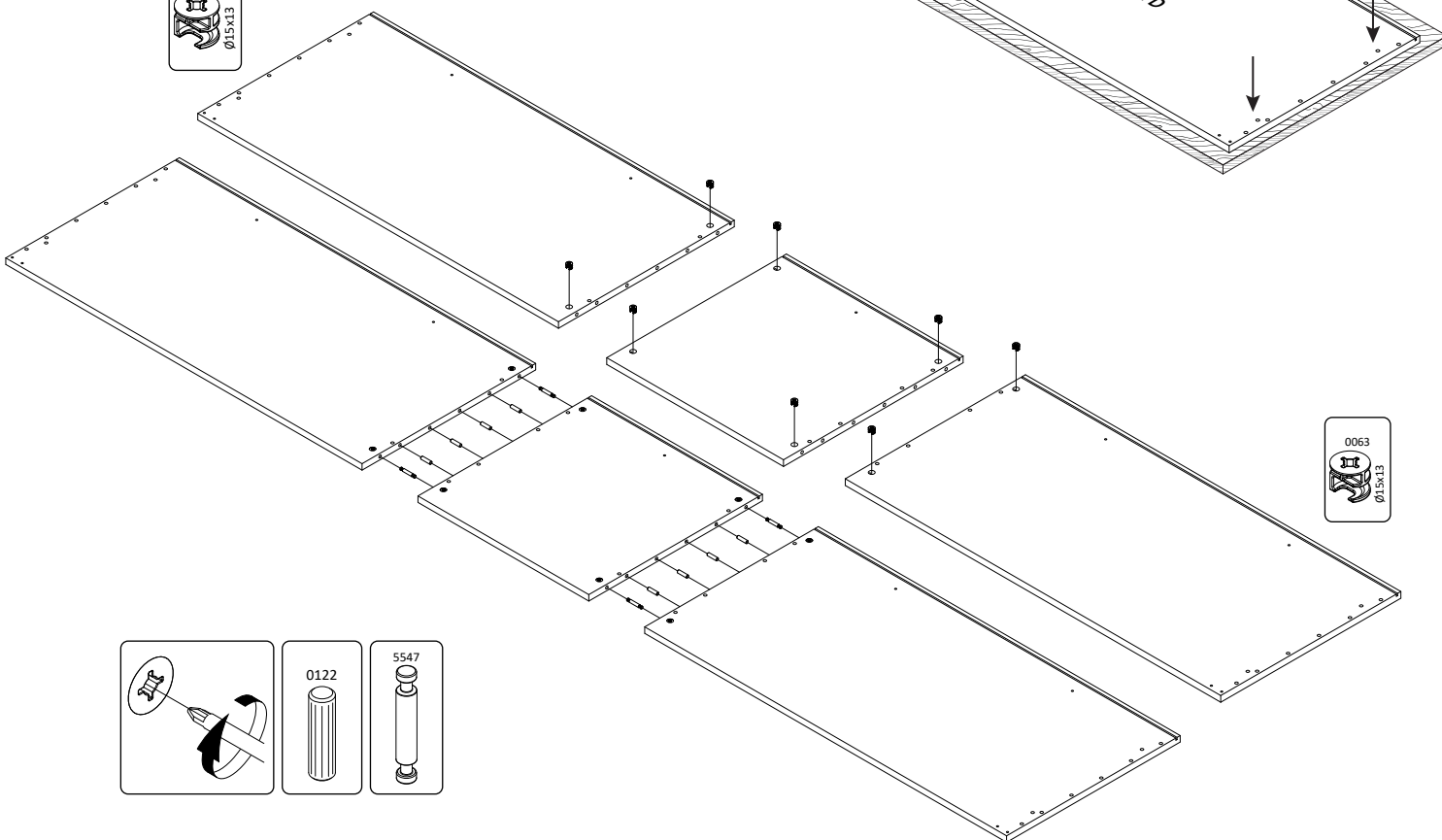
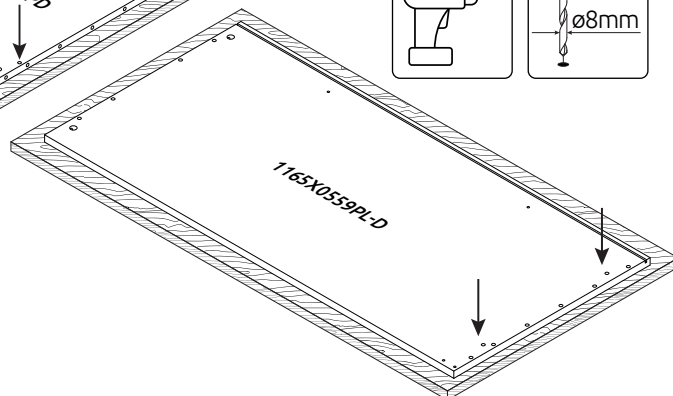
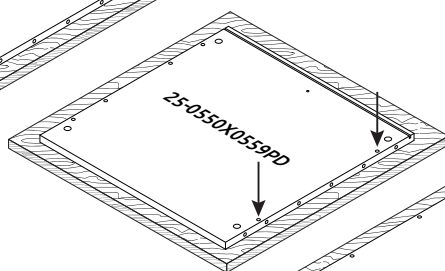
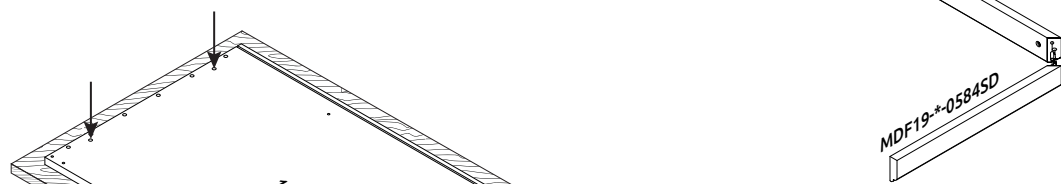
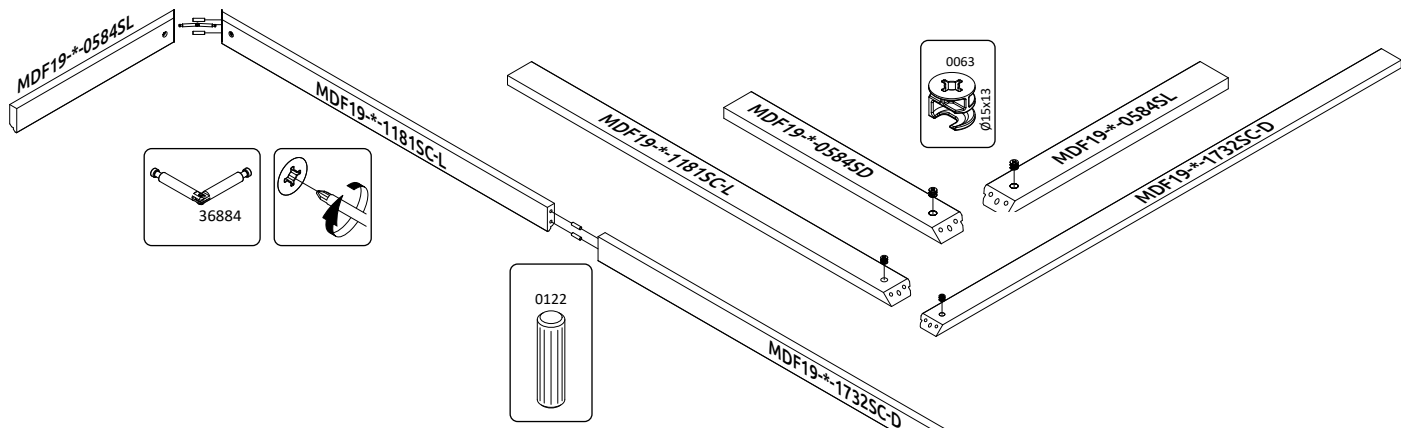

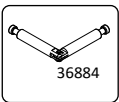
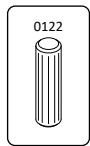
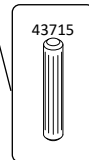
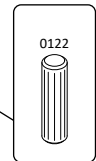
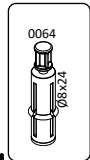
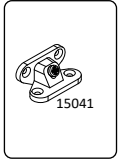
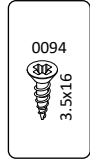
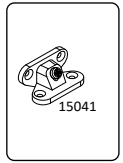
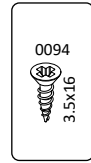
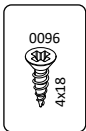

MDF18-49-0584PD

MDF18-49-1181C-L

MDF18-49-1732C-D

MDF18-49-1181C-L

MDF18-49-0584PD

MDF18-49-1732C-D

MDF18-49-0584PL

MDF18-49-0584PL

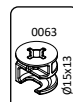

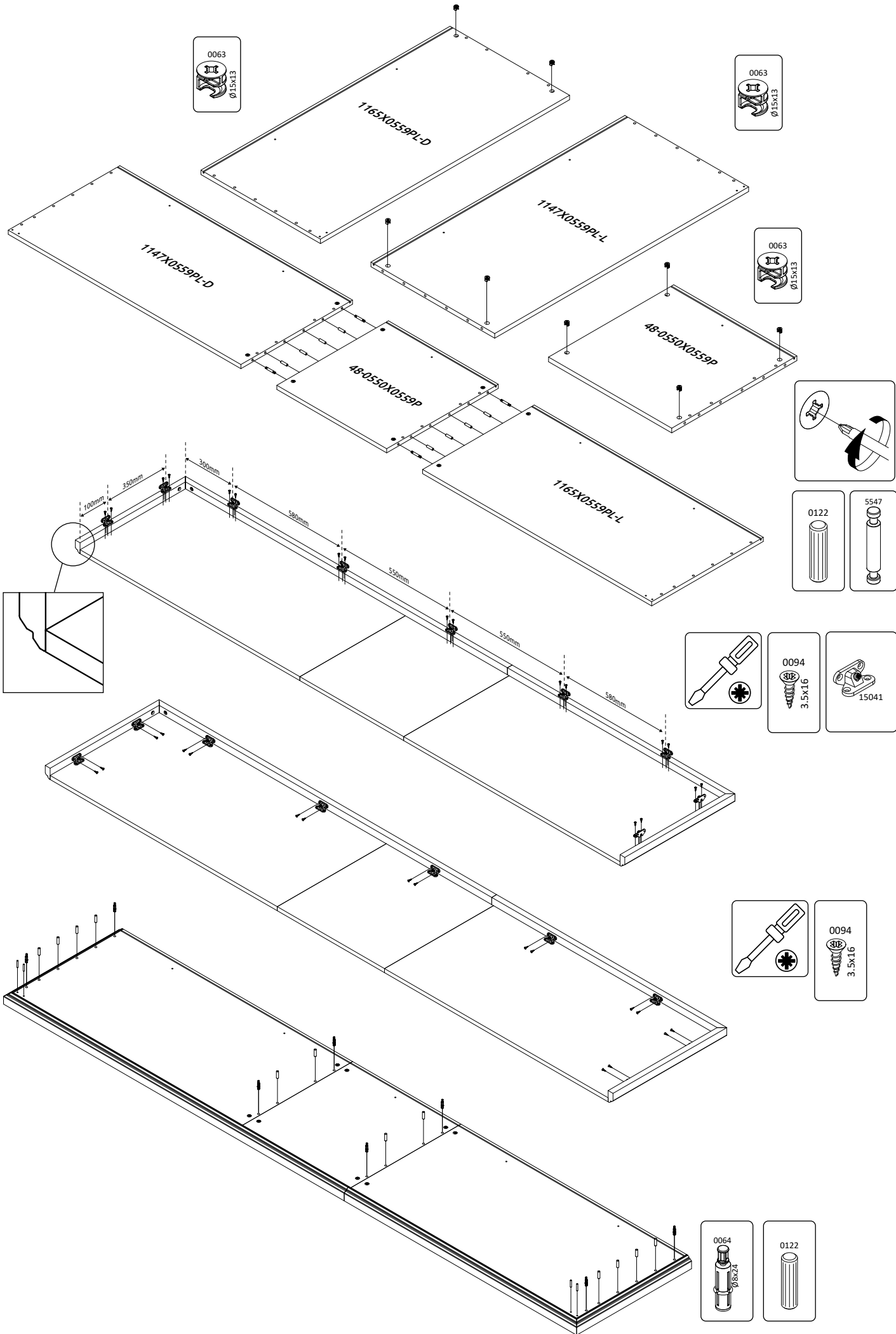

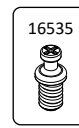
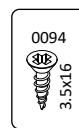
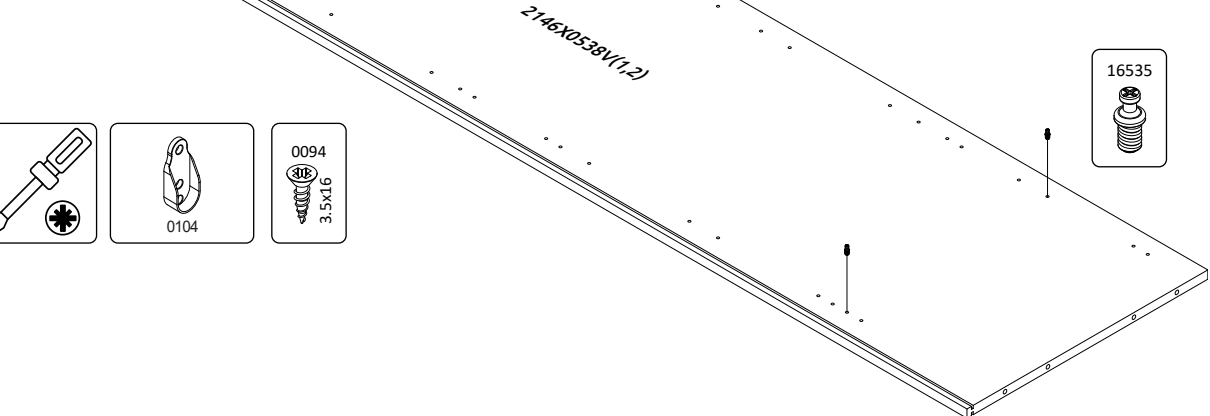
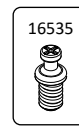
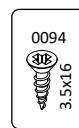
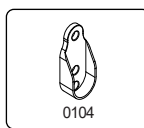
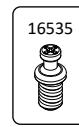
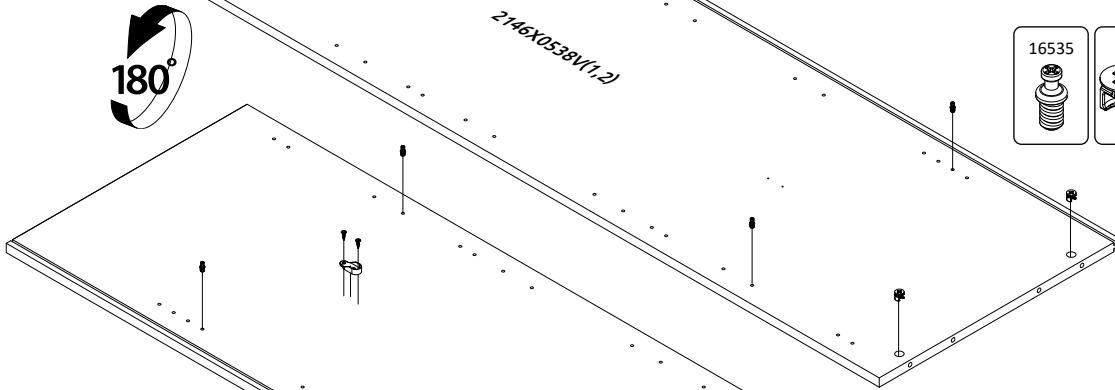
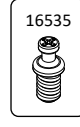
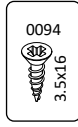
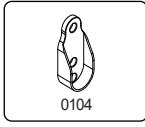
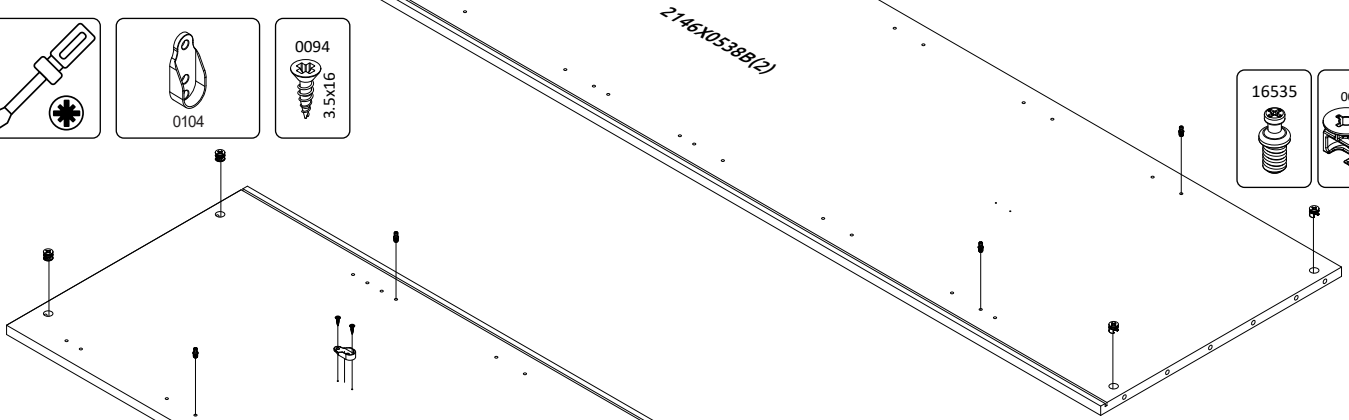
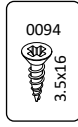
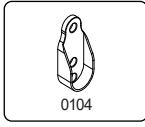
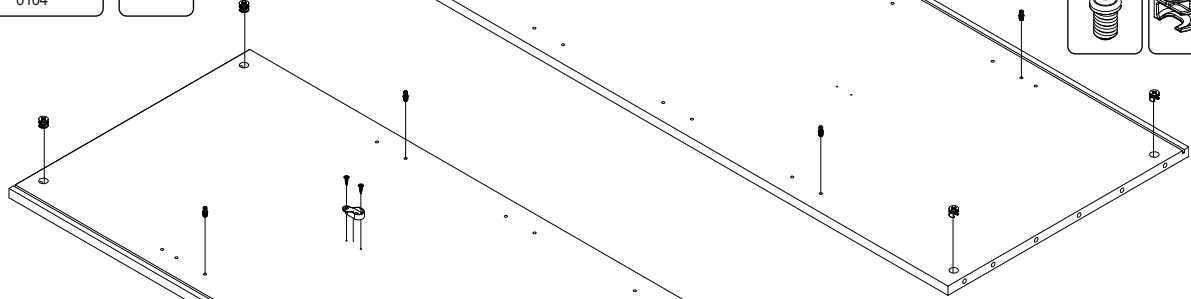
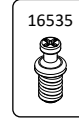
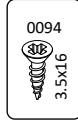
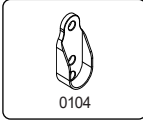
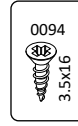
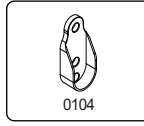
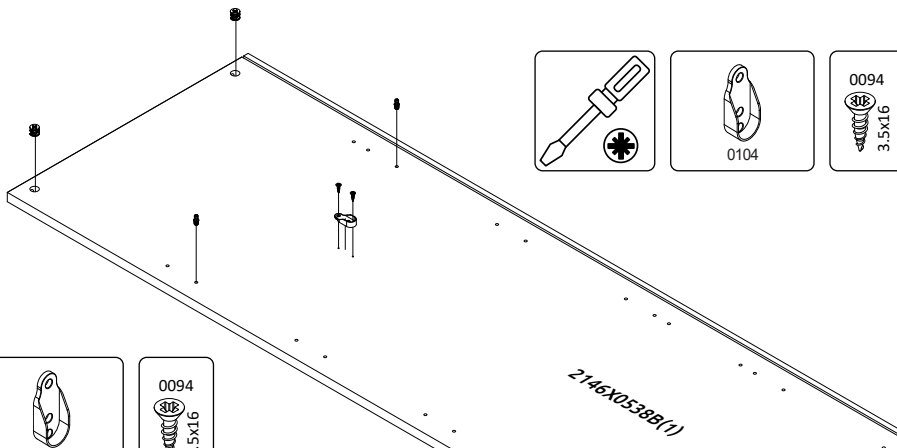

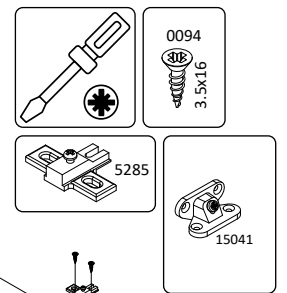
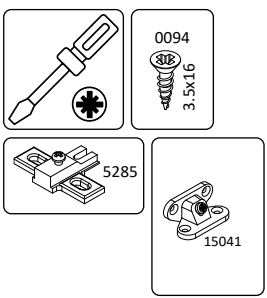
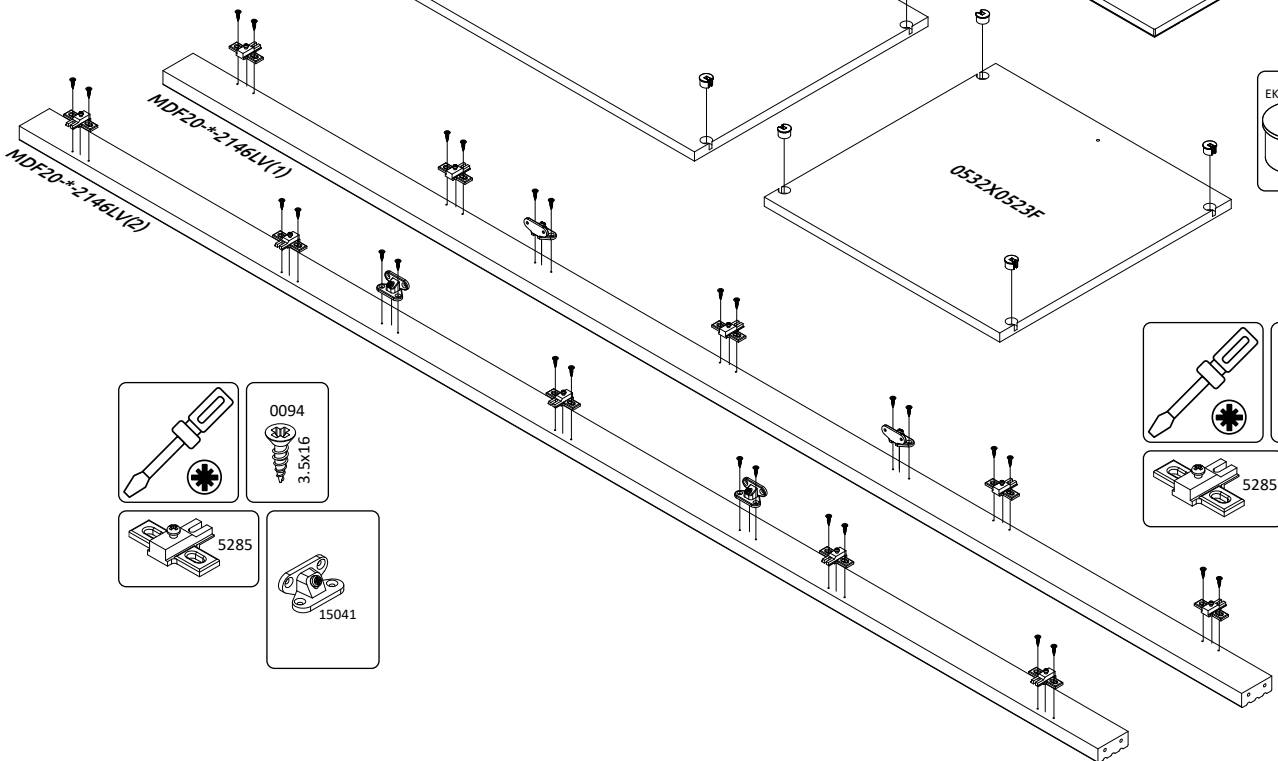
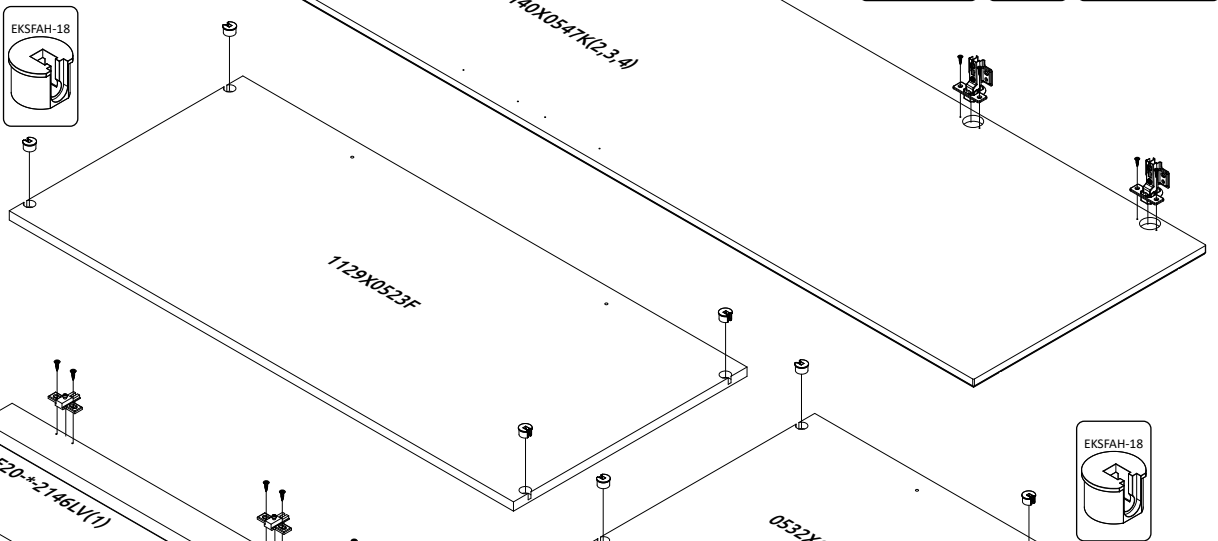
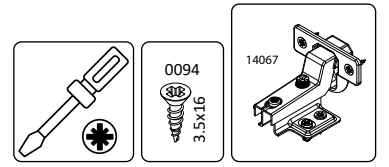
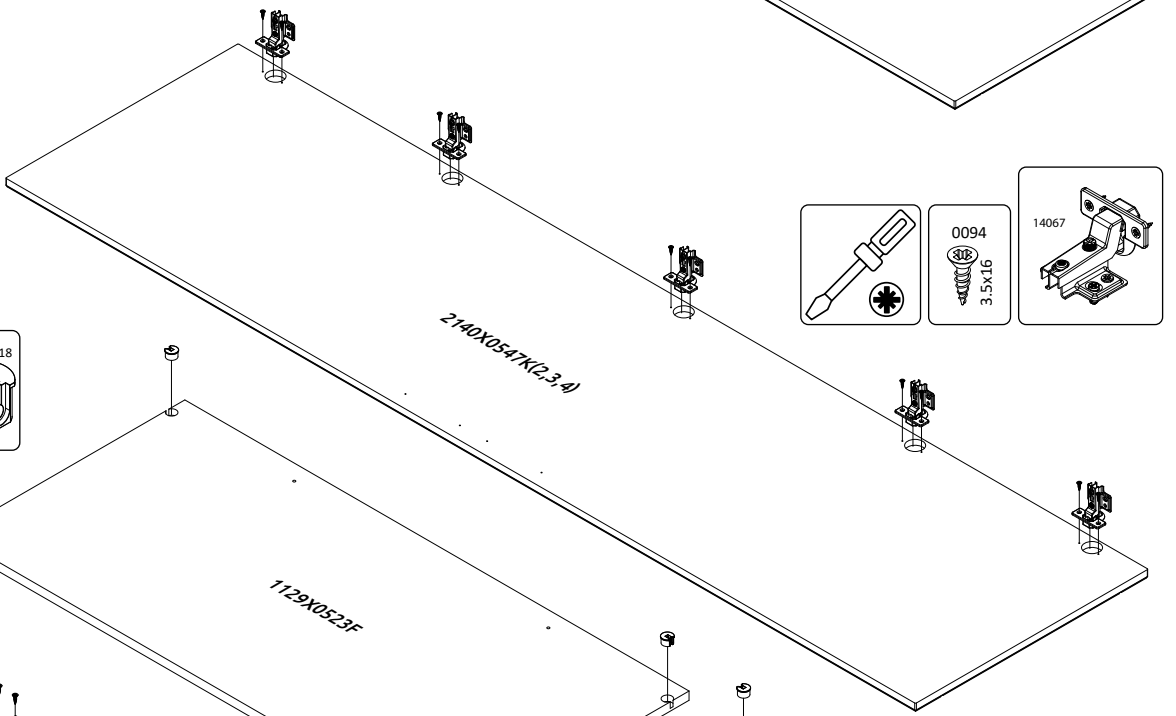
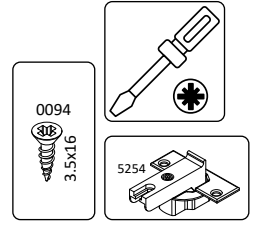
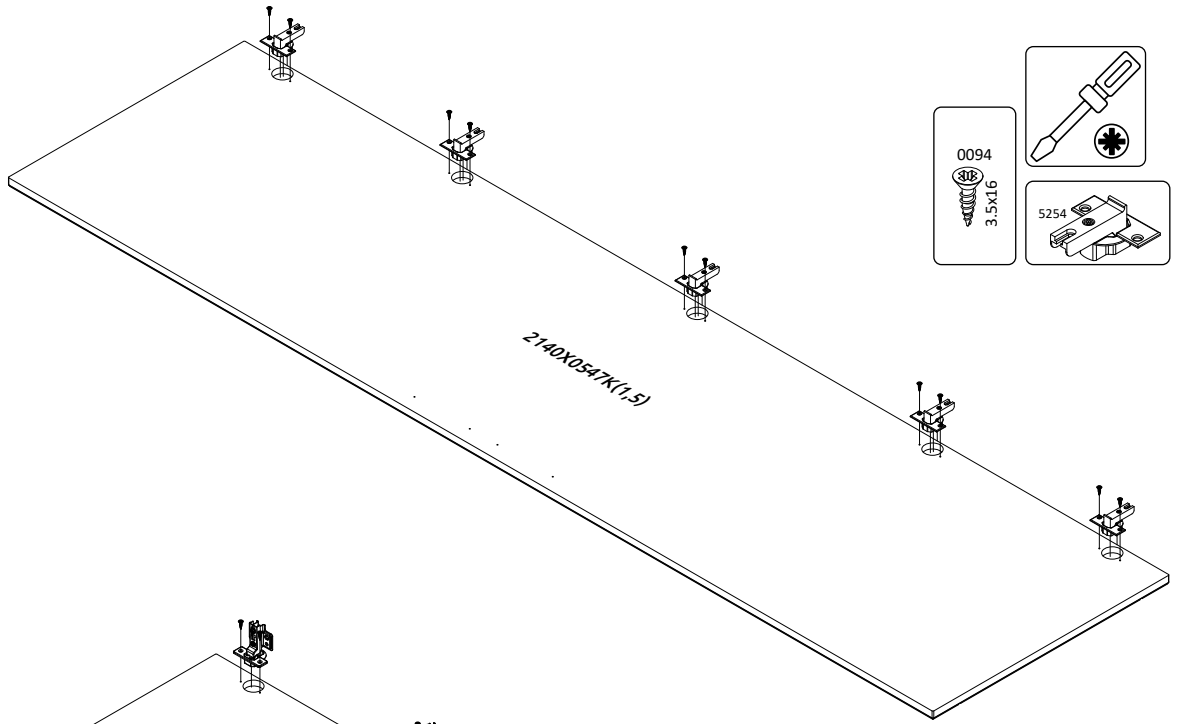

1

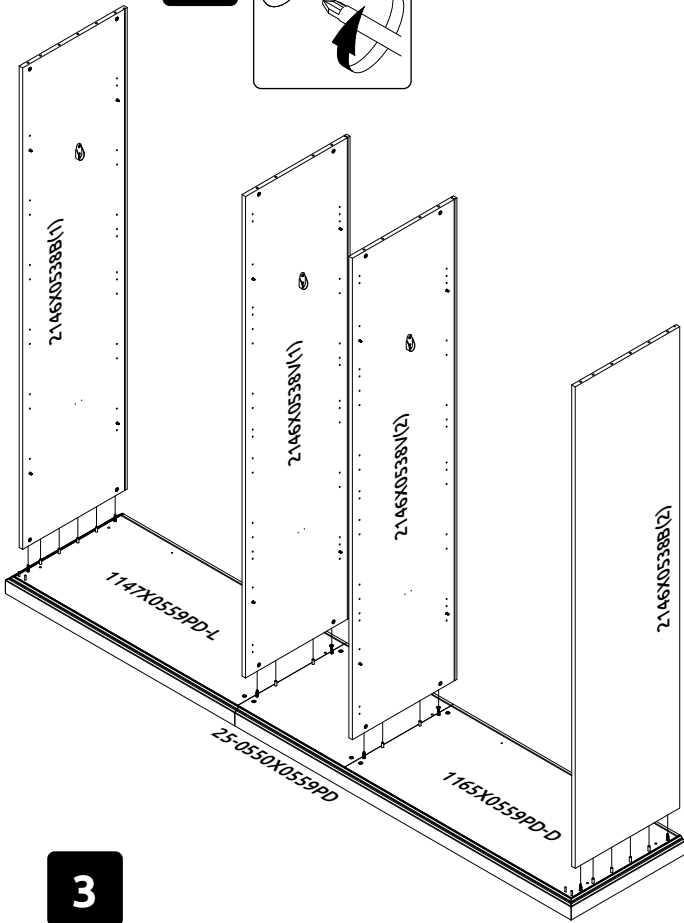
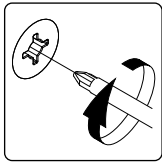

2

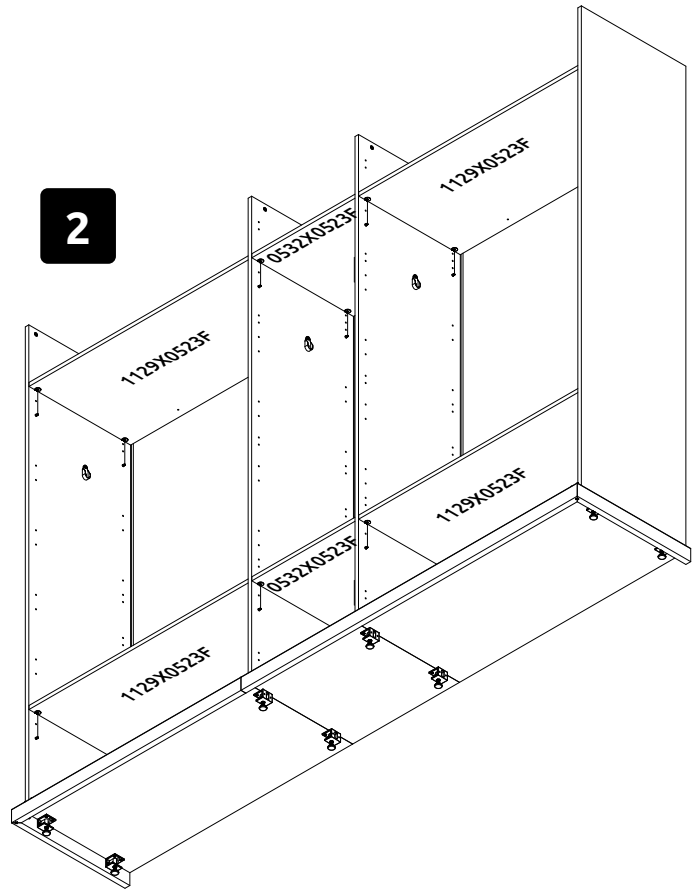

3

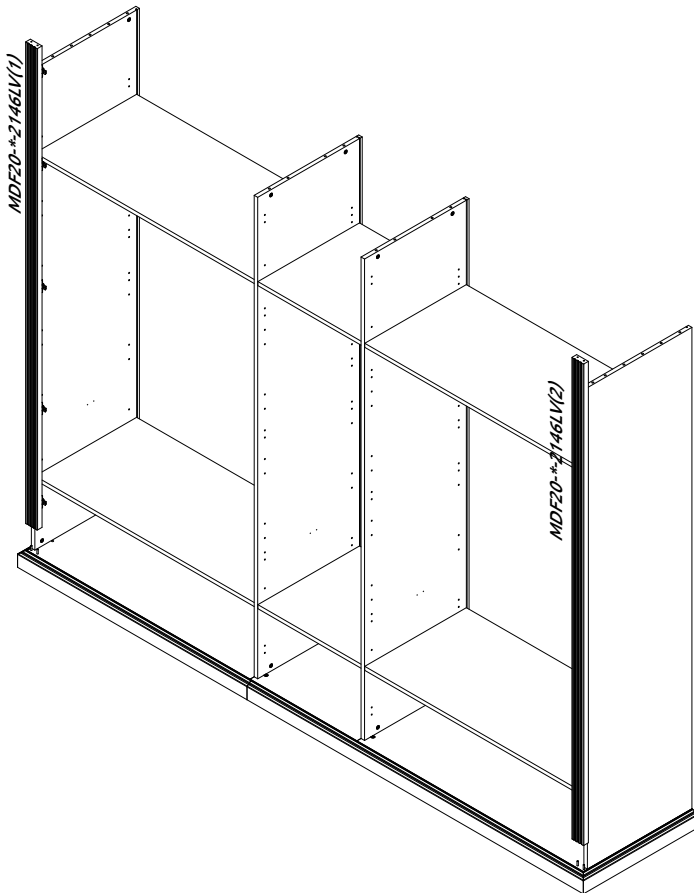

4

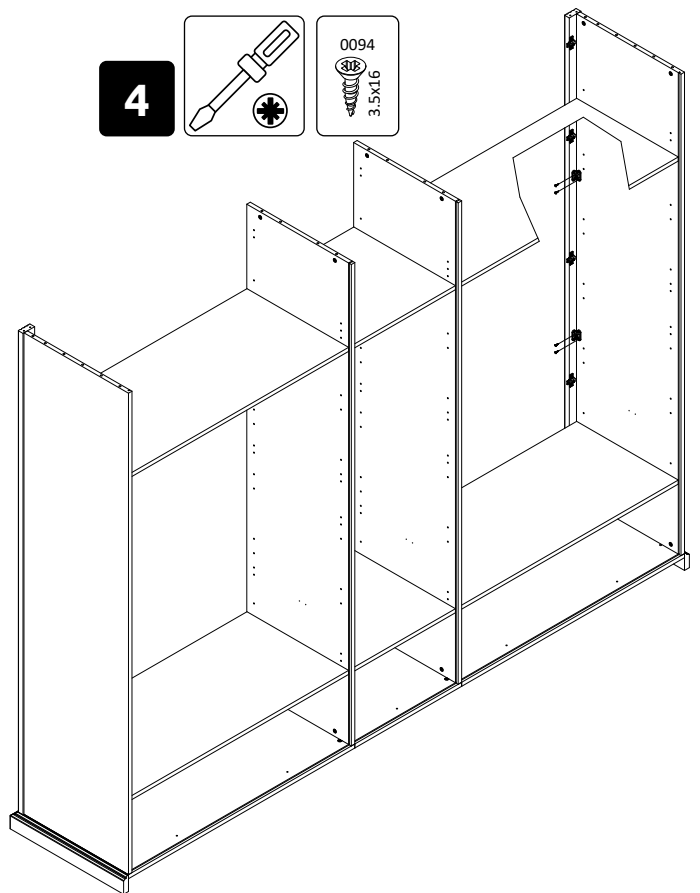
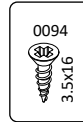

5

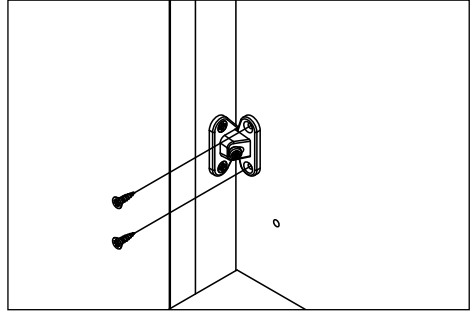
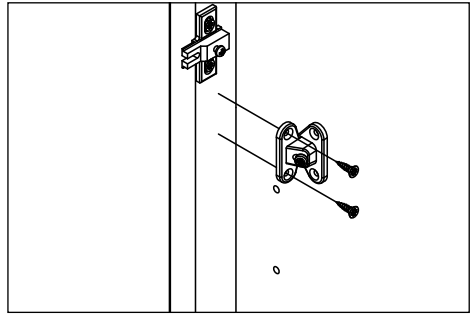
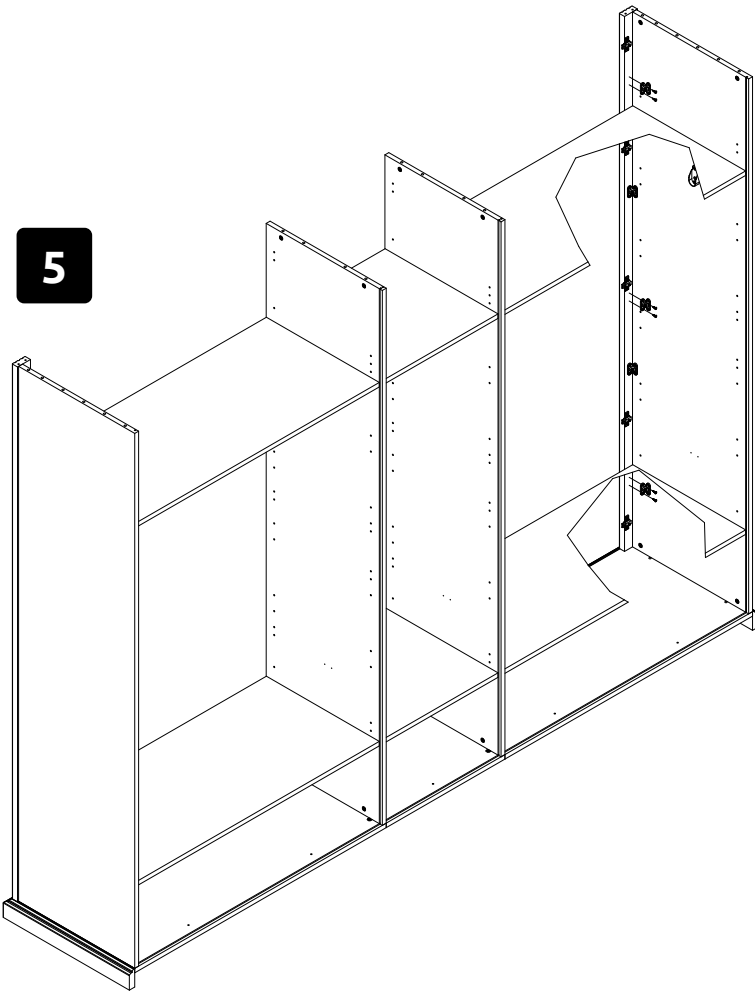

7

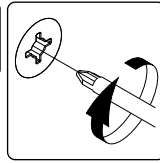

6

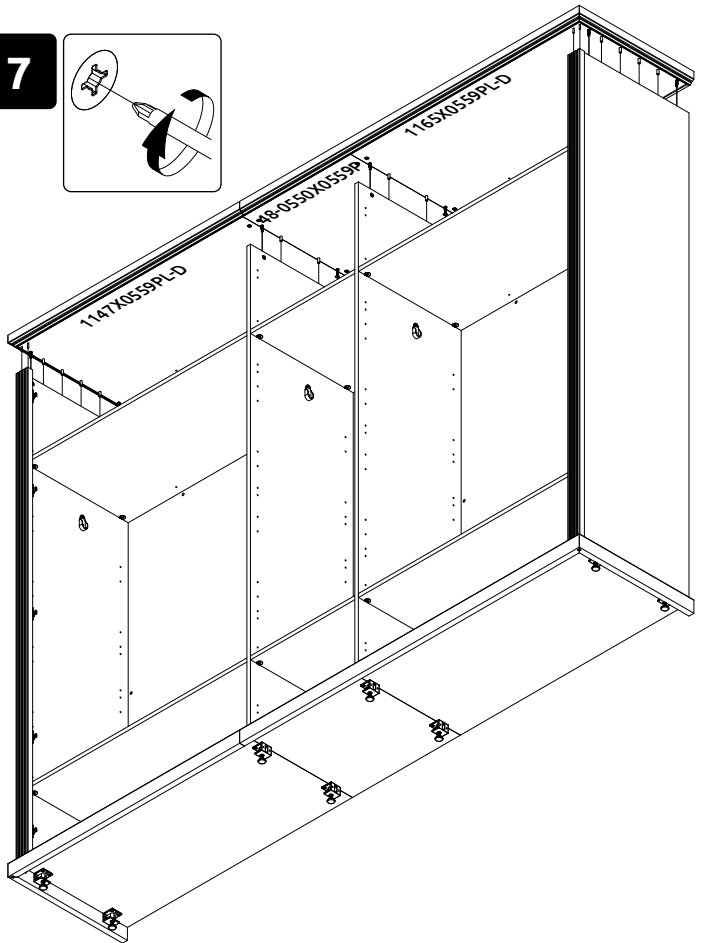
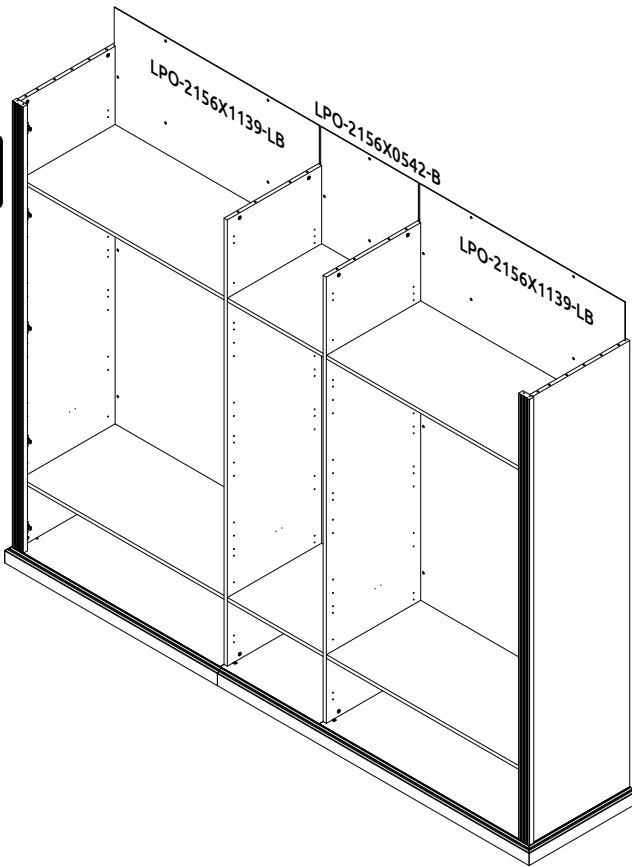

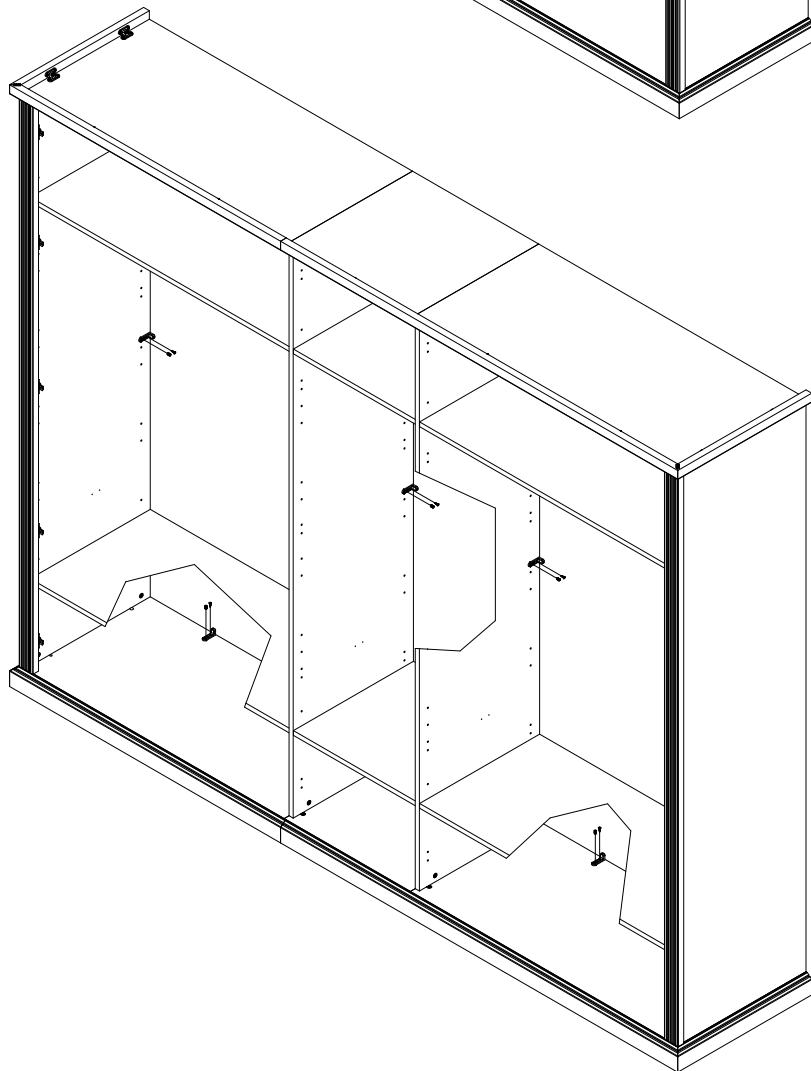
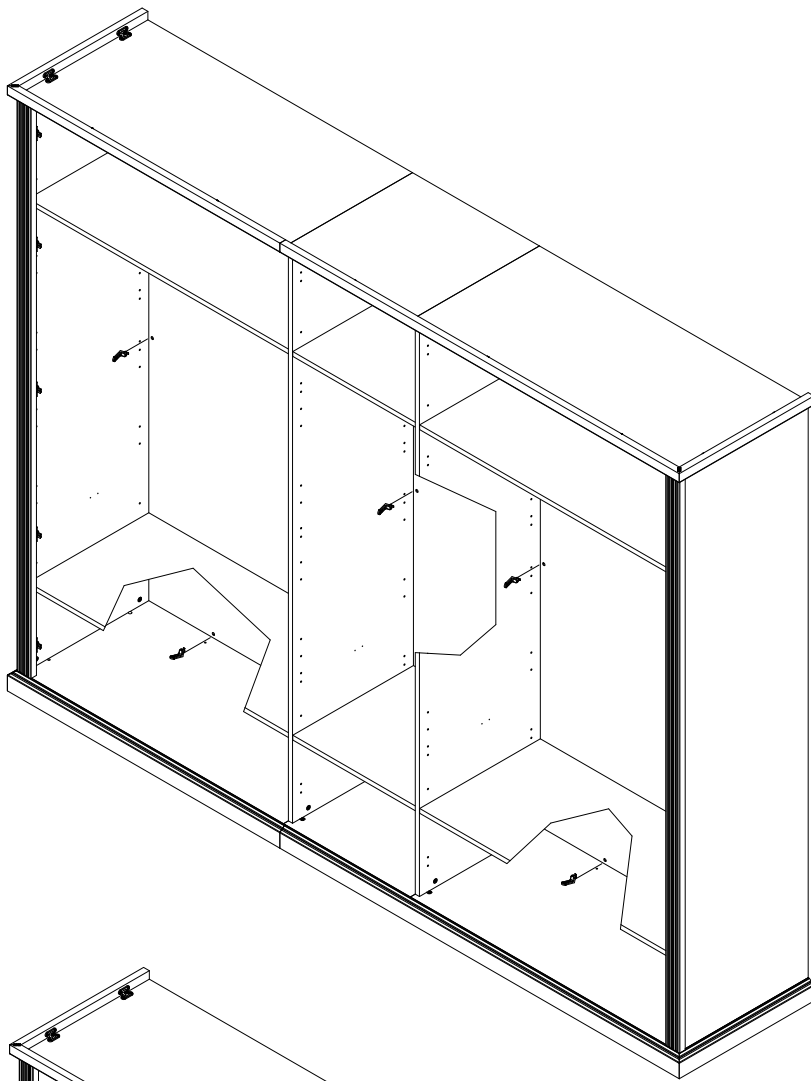

8

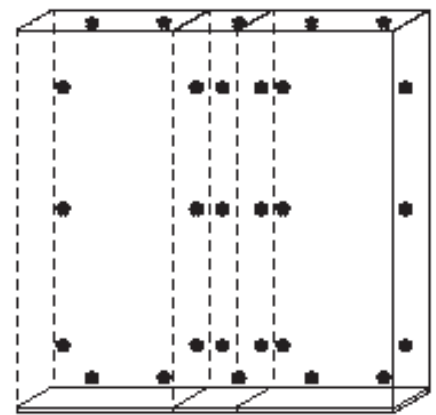
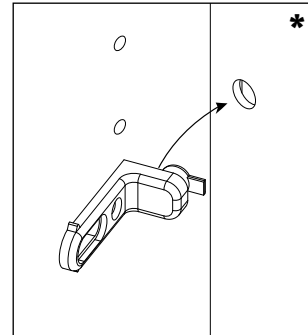
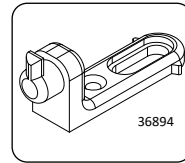

9

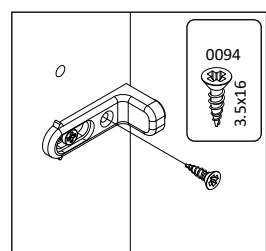
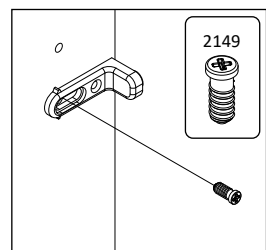
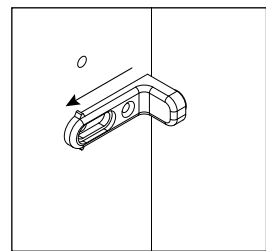

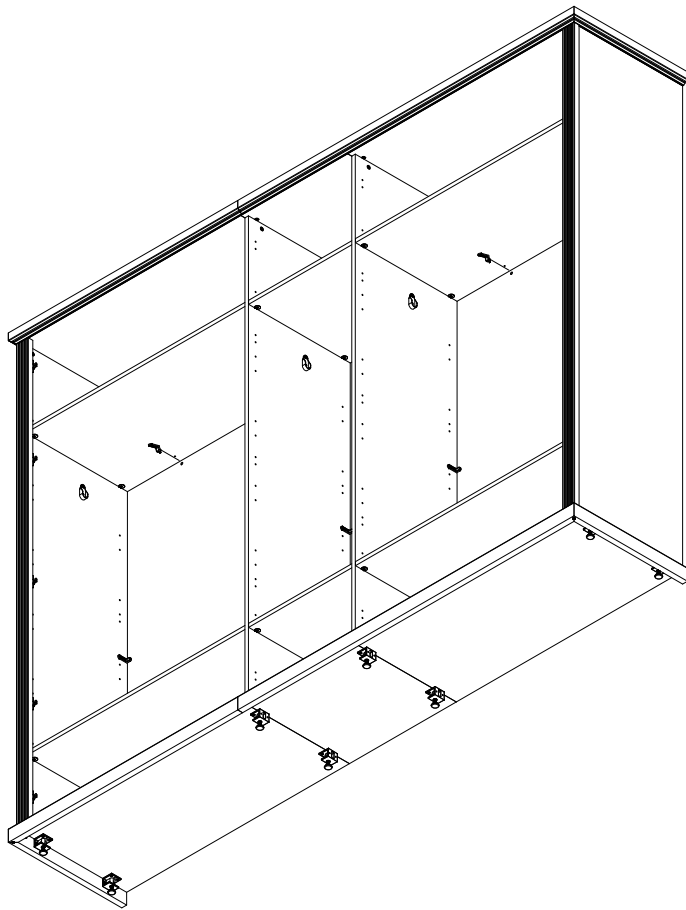

10

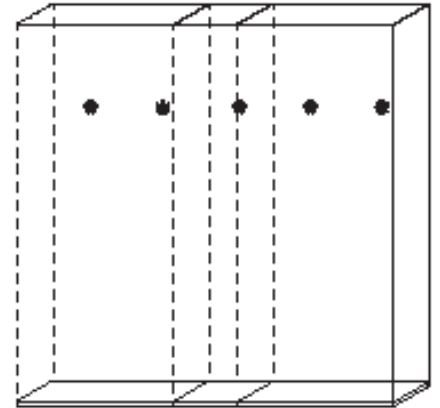
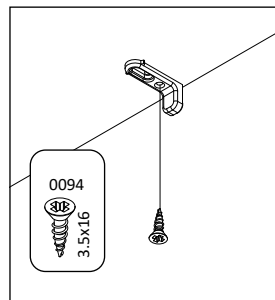
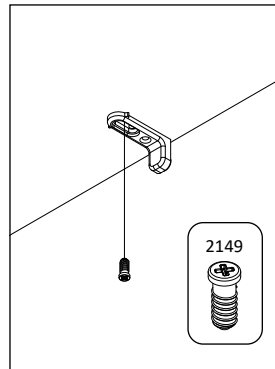
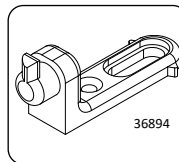

11

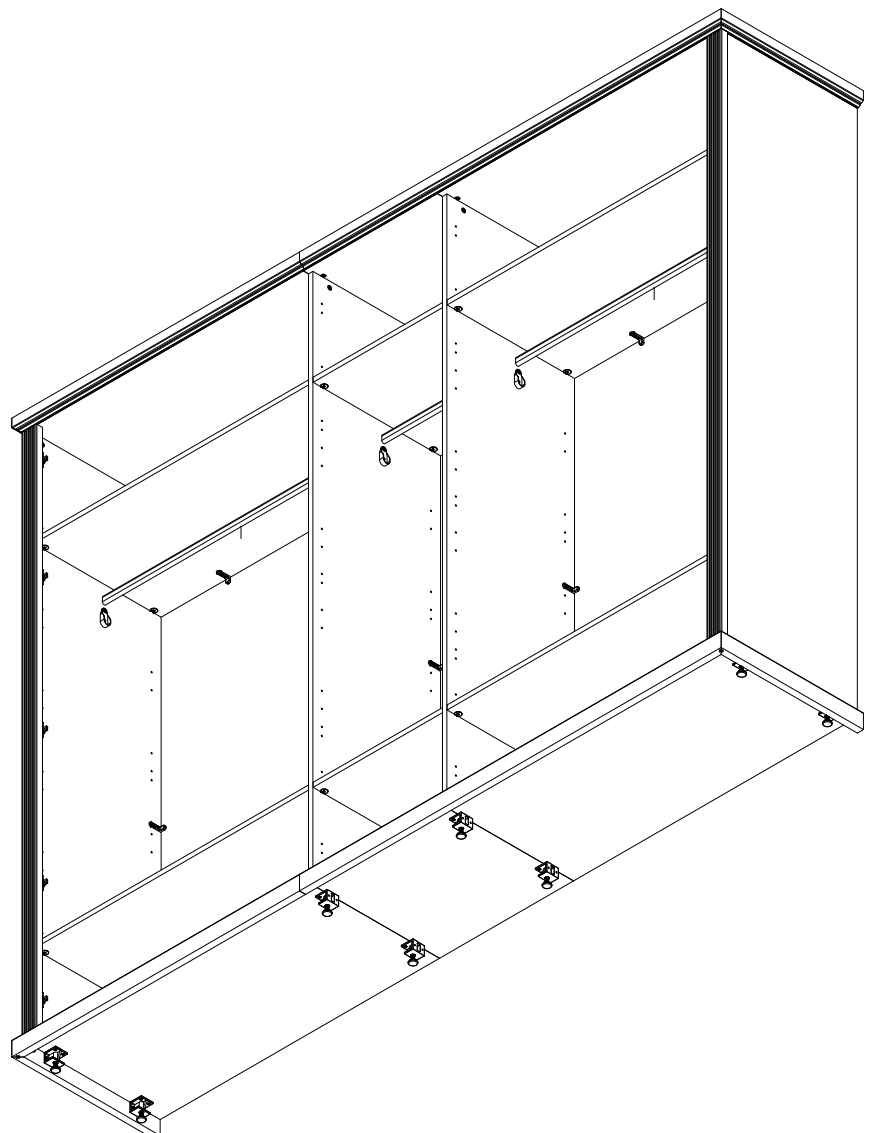

12

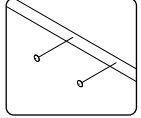
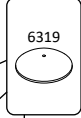
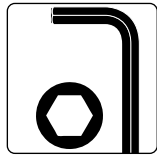
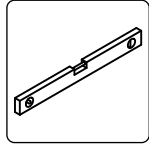

13

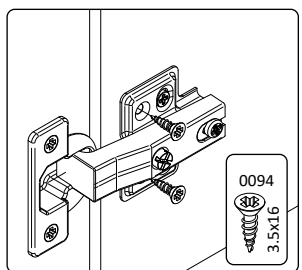
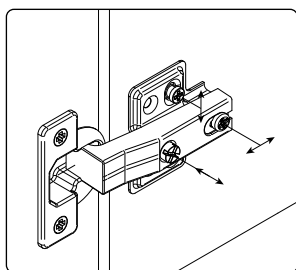
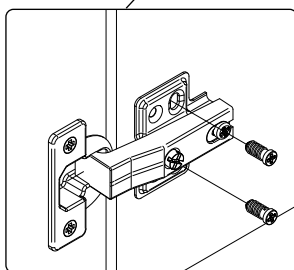
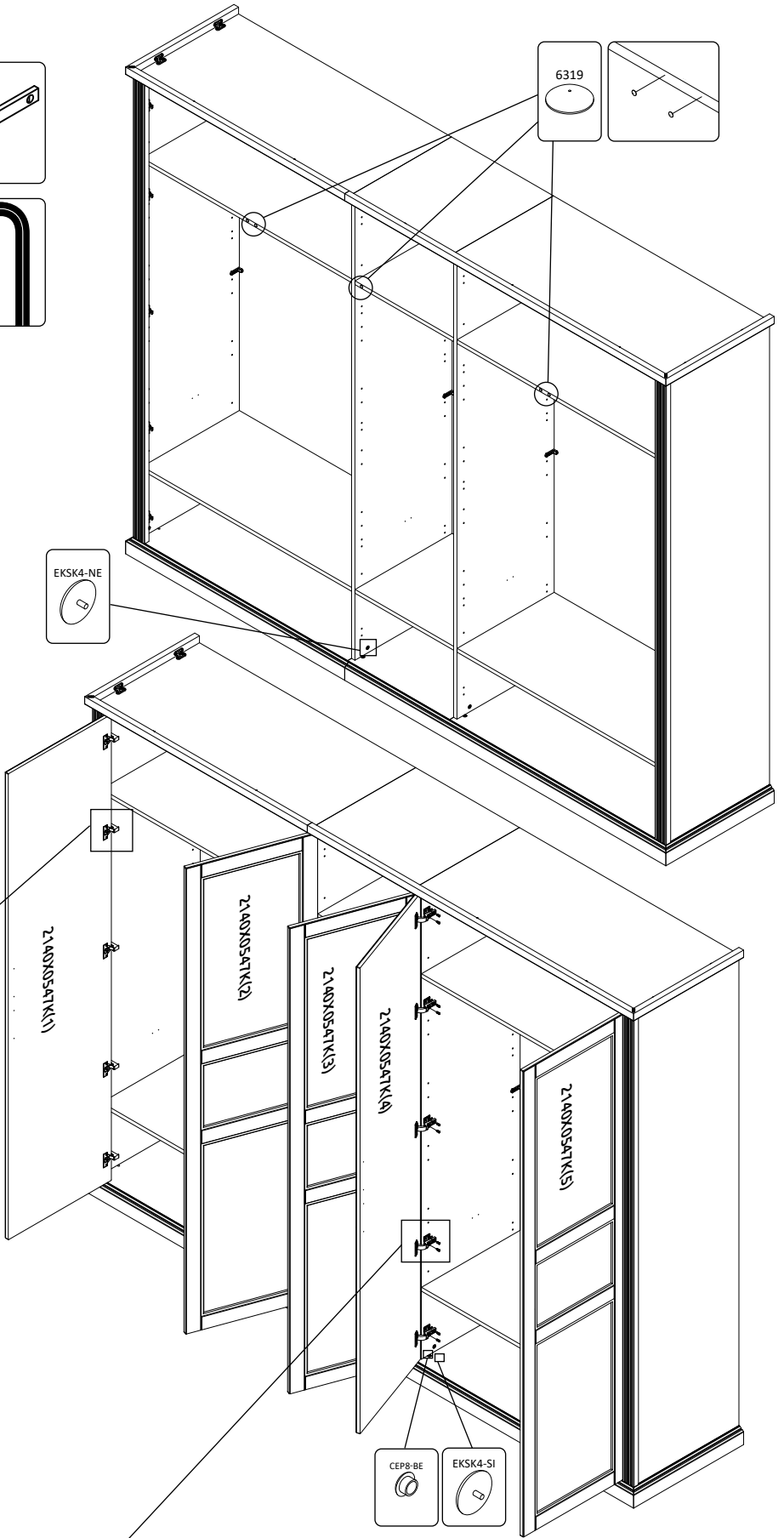
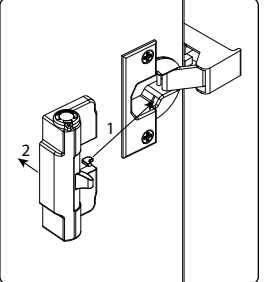
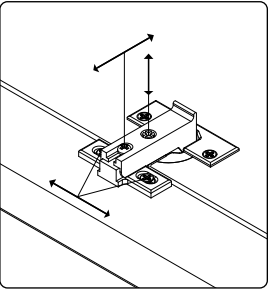
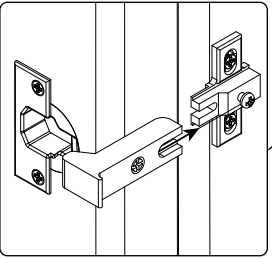

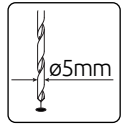
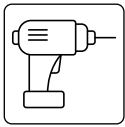

14

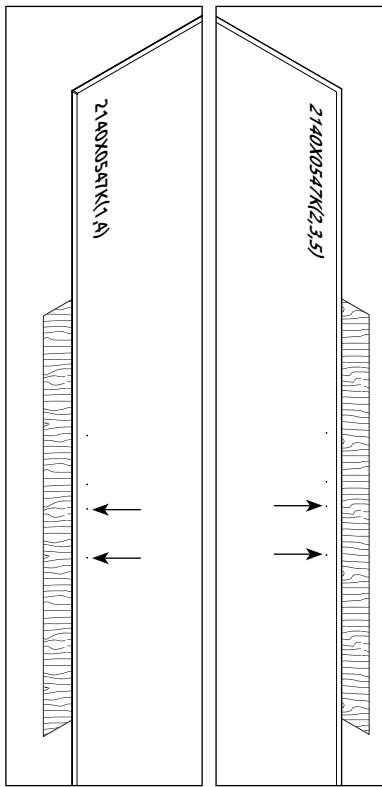

15

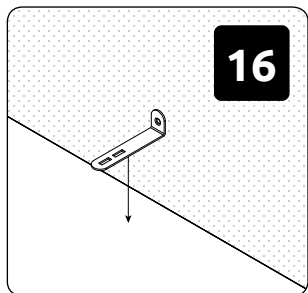
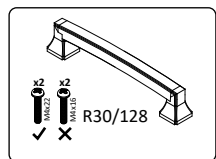
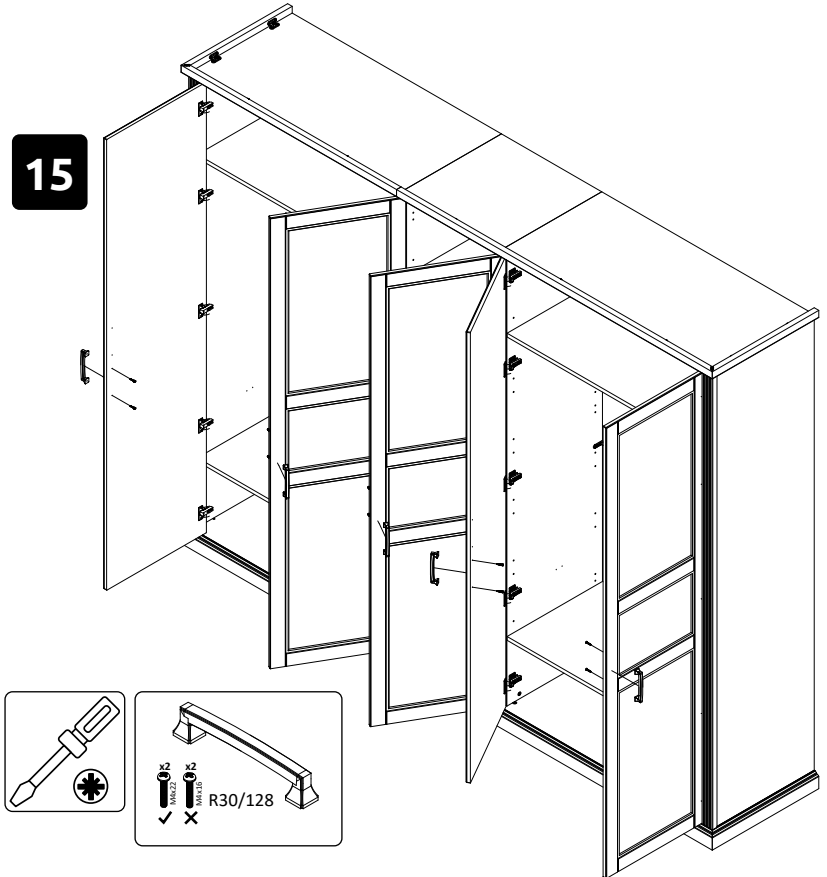

16

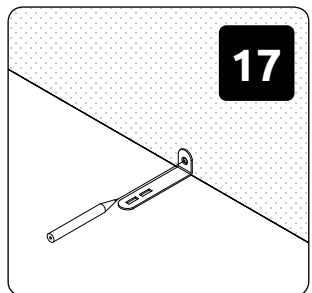

17

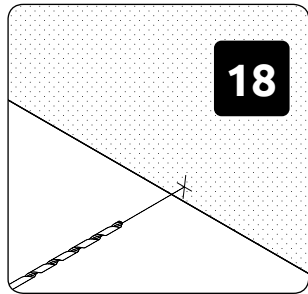

18

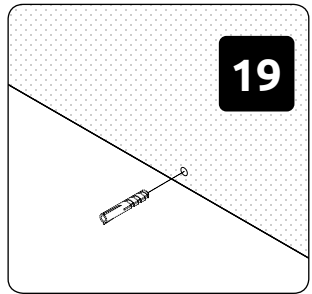

19

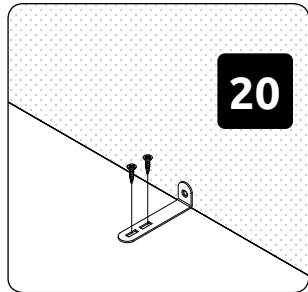

20

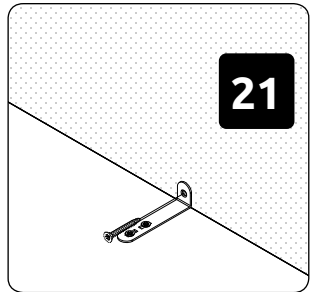

21

