

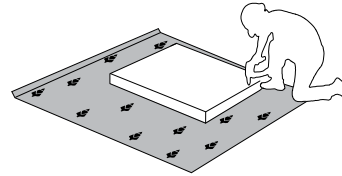

IMPORTANT - READ CAREFULLY - RETAIN FOR FUTURE REFERENCE
WICHTIG - SORGFÄLTIG LESEN UND AUFBEWAHREN

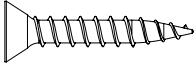

DP2/10G-AR
LWH - 900x555x2236

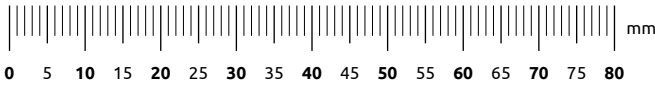
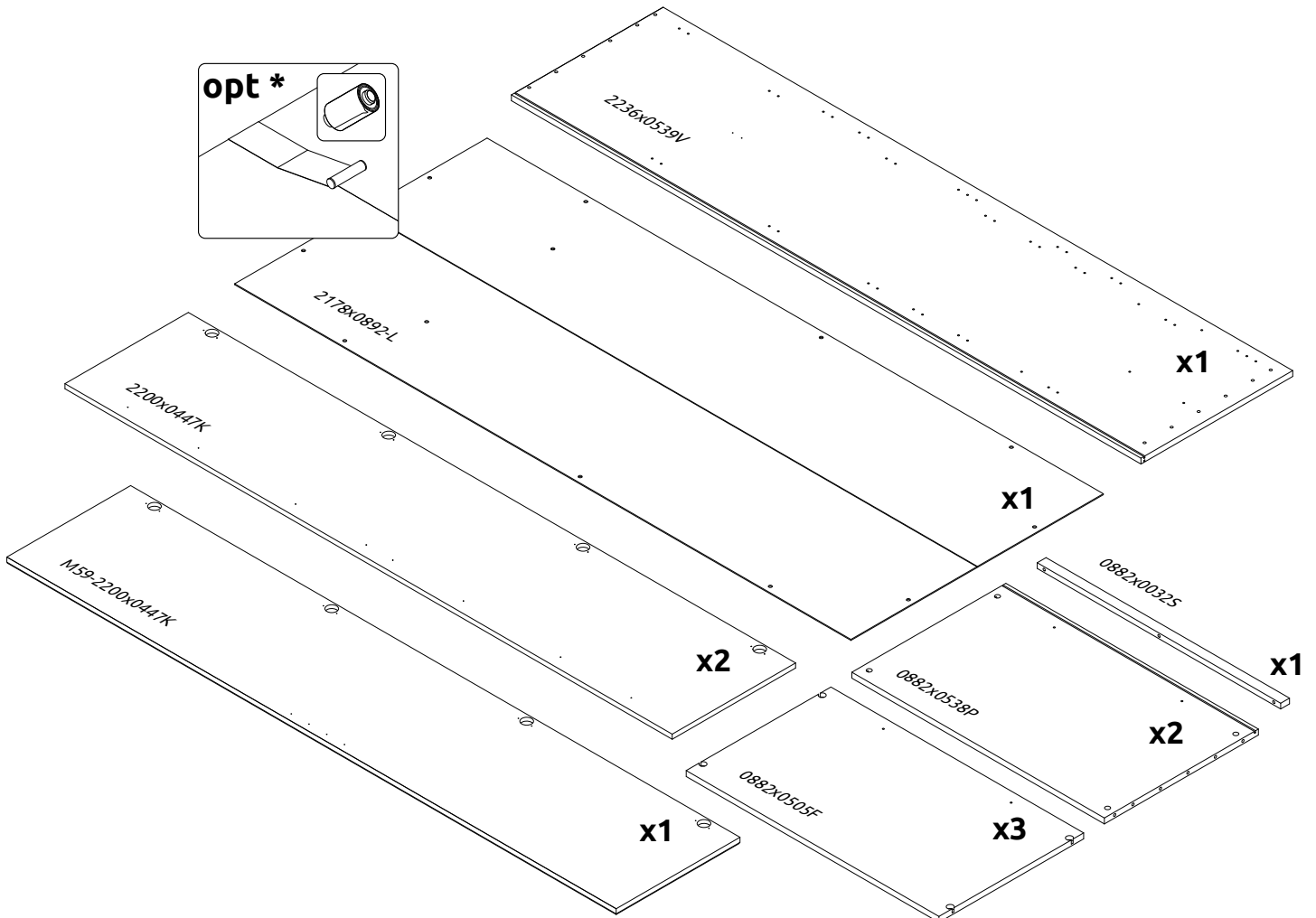
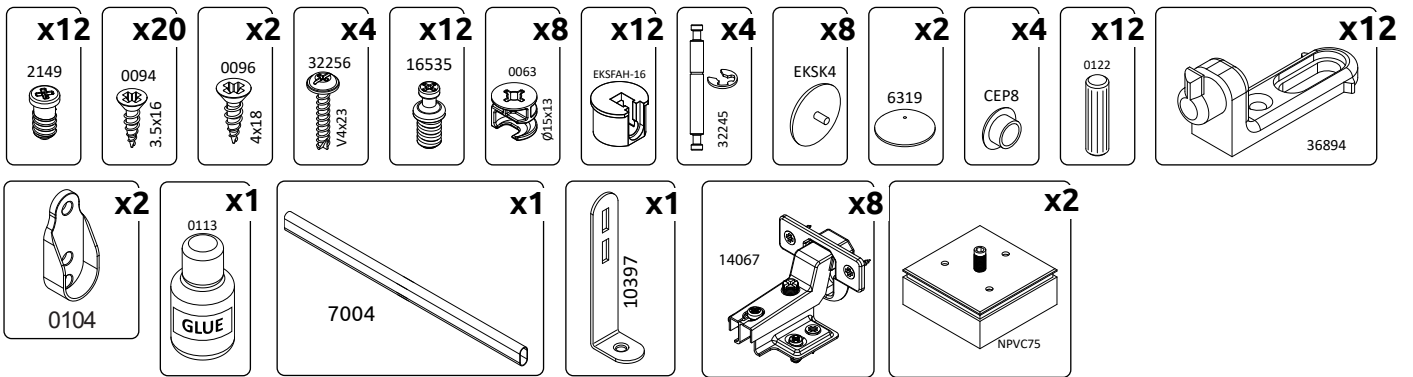



0882x0505F

0882x0538P(1)

0882x0538P(2)

0882x0538P(2)

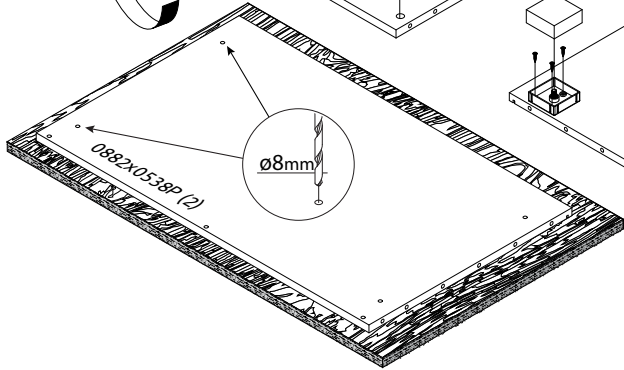
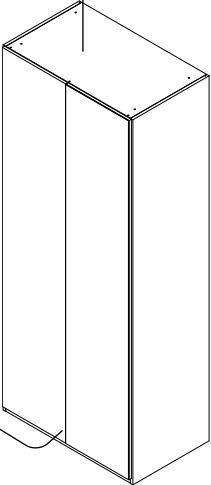

Ø8mm

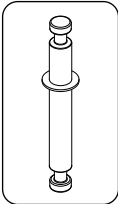
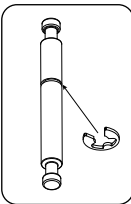
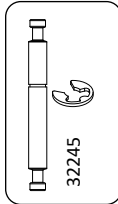
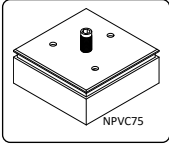
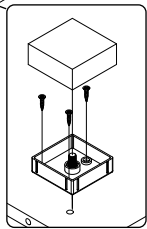

2200x0447K

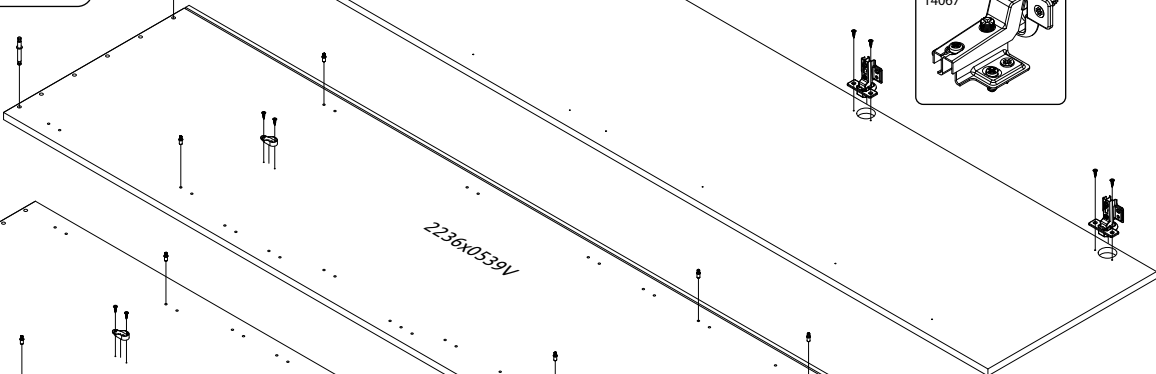
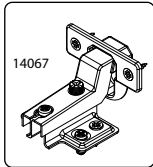

2236x0539V

2236x0539V

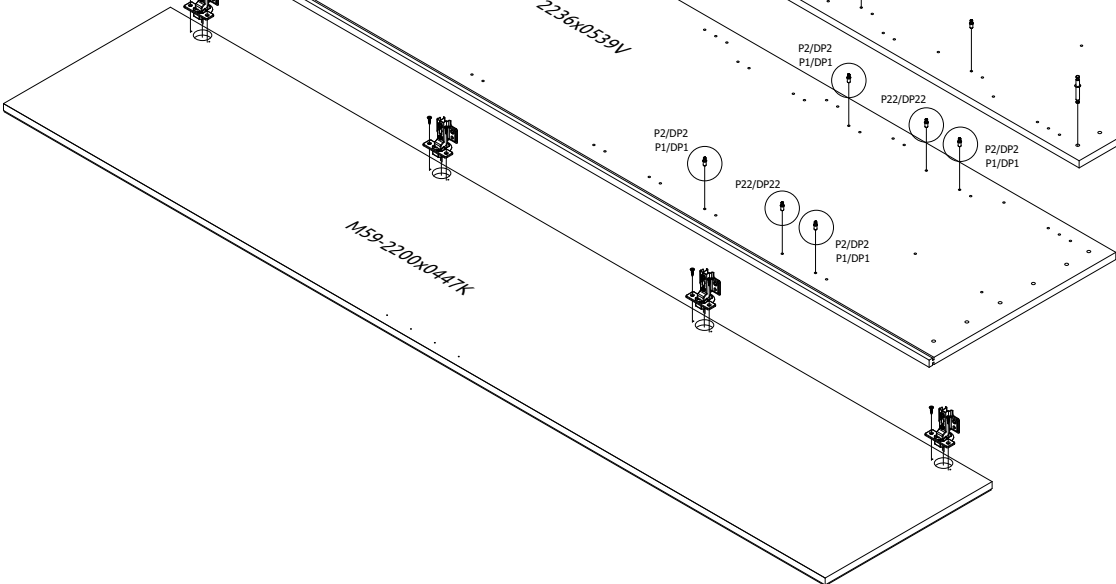

M59-2200x0447K

P2/DP2
P1/DP1

P22/DP22

P2/DP2
P1/DP1

P22/DP22

P2/DP2
P1/DP1



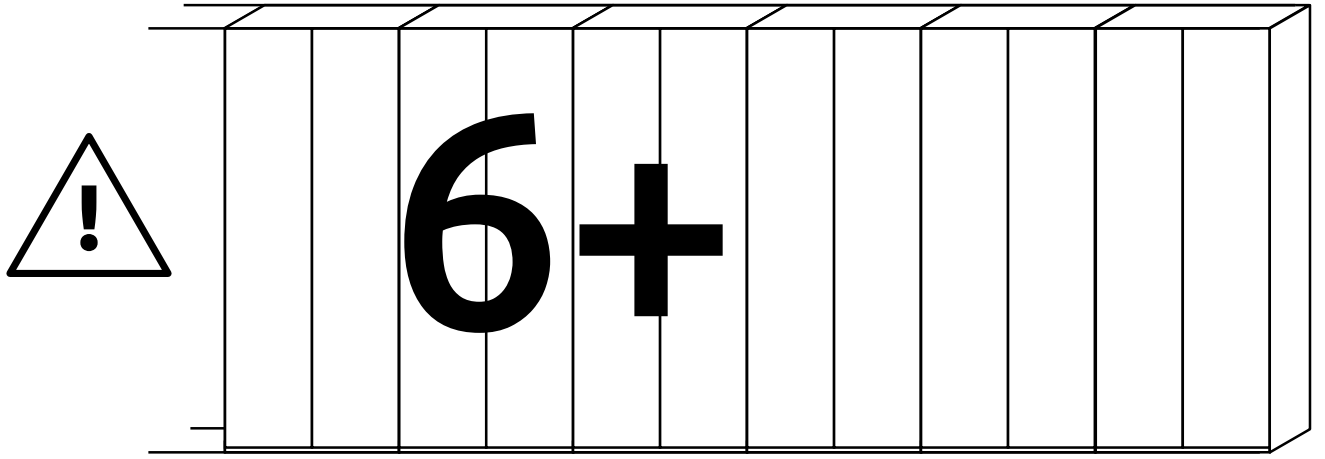

1 →

← 2

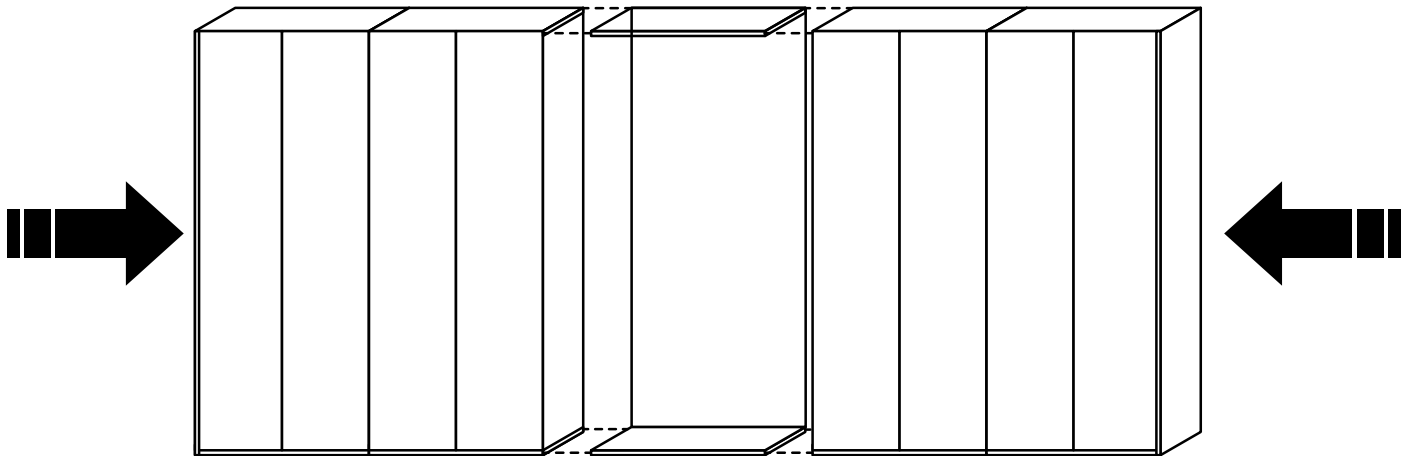
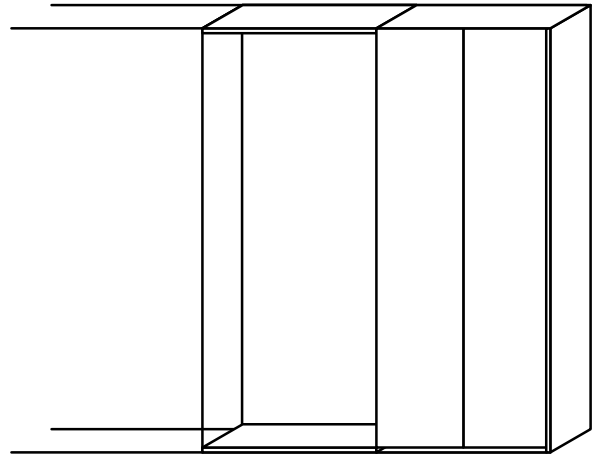
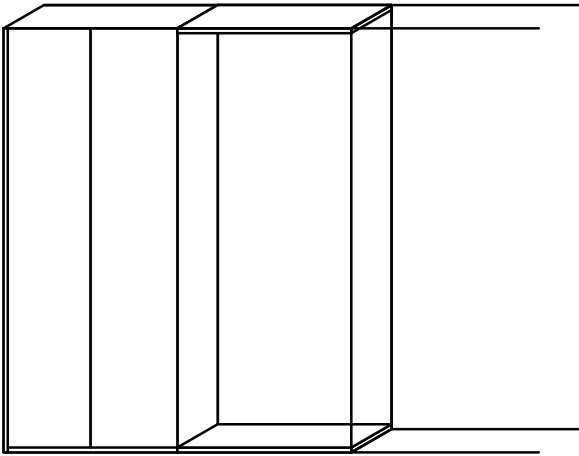

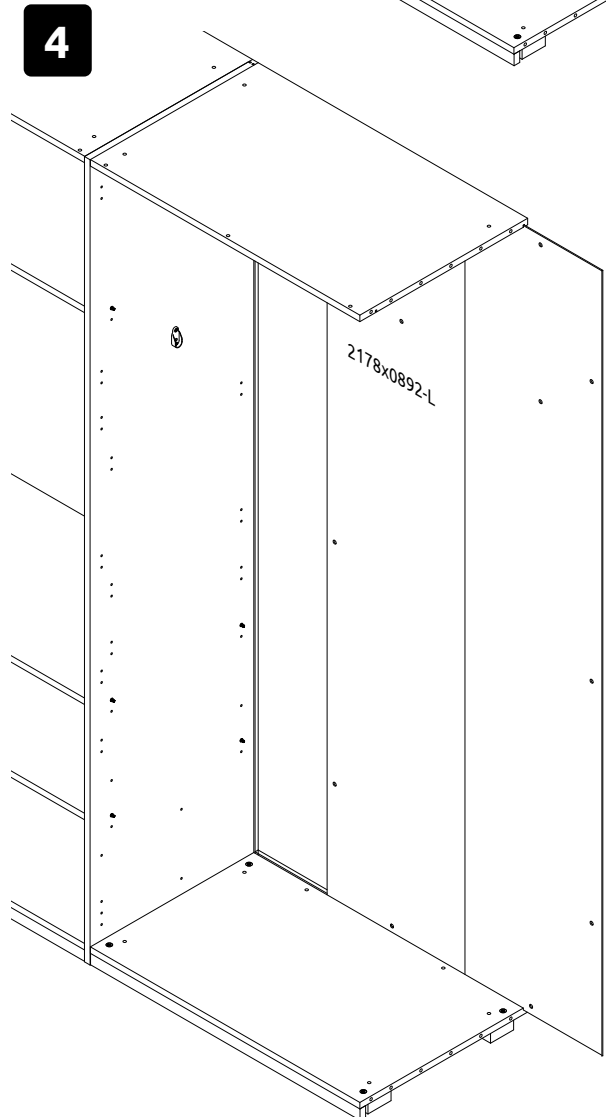
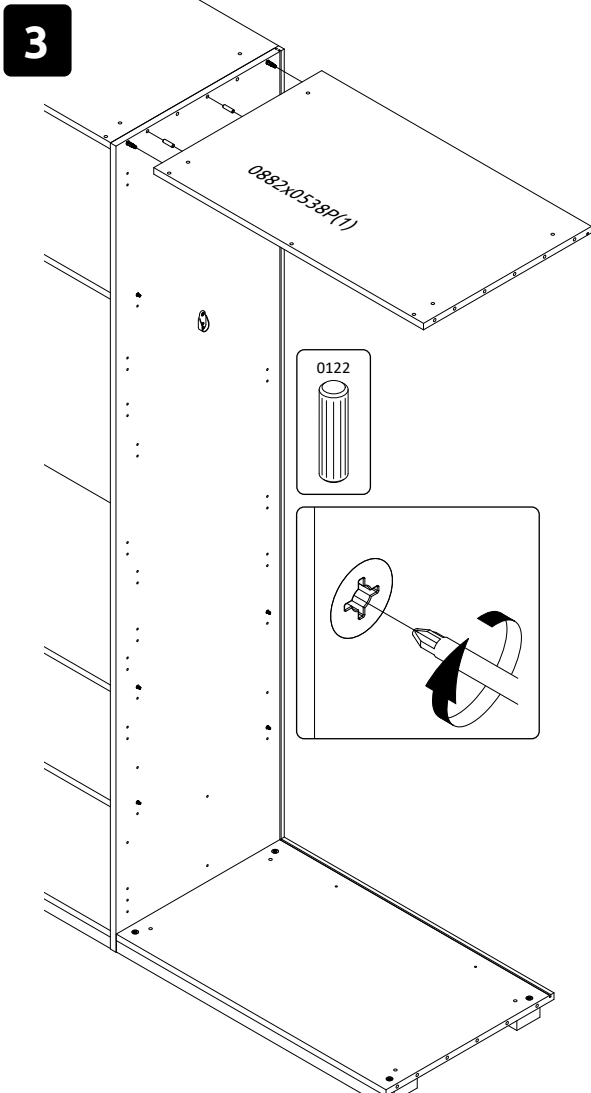
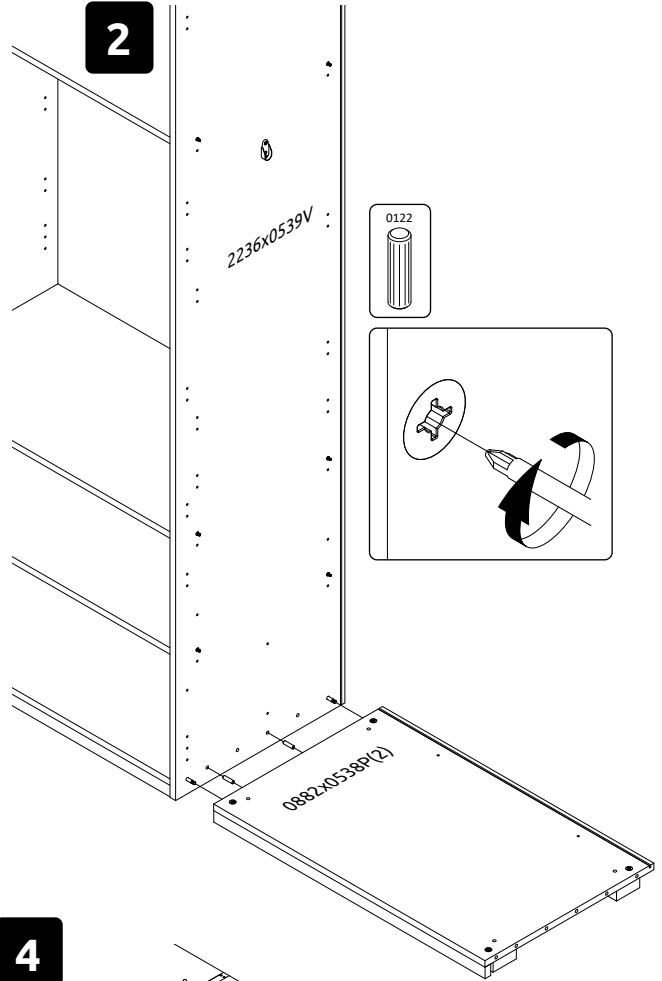
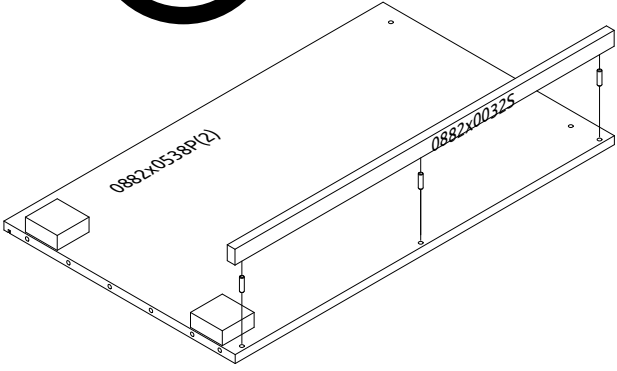
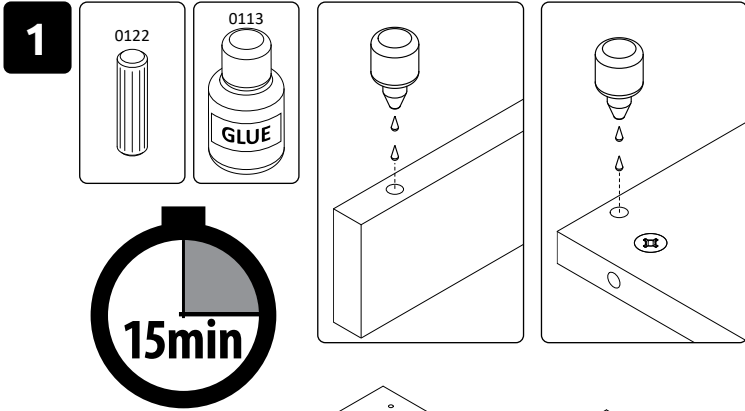

5 

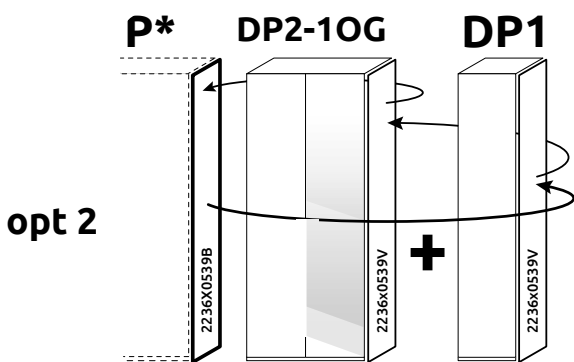
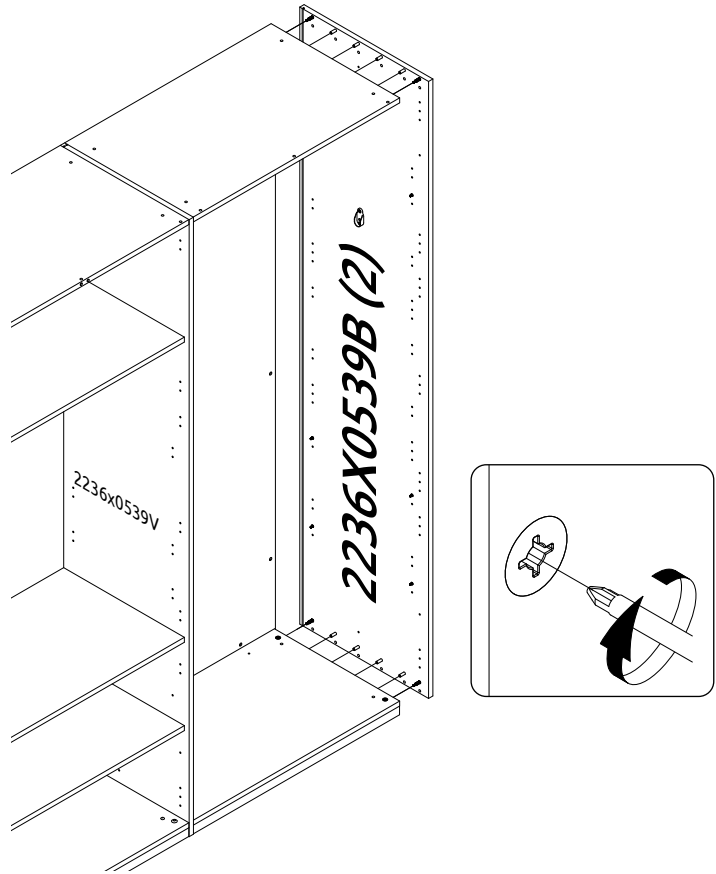
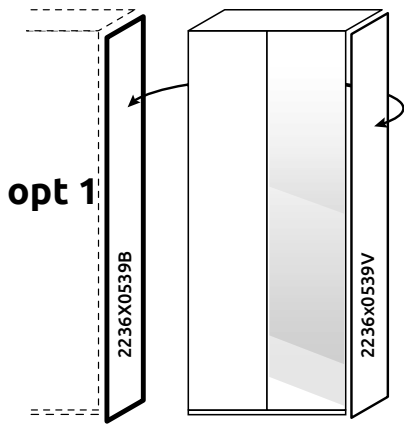

P* = P1 / P2 / P22 / PUG

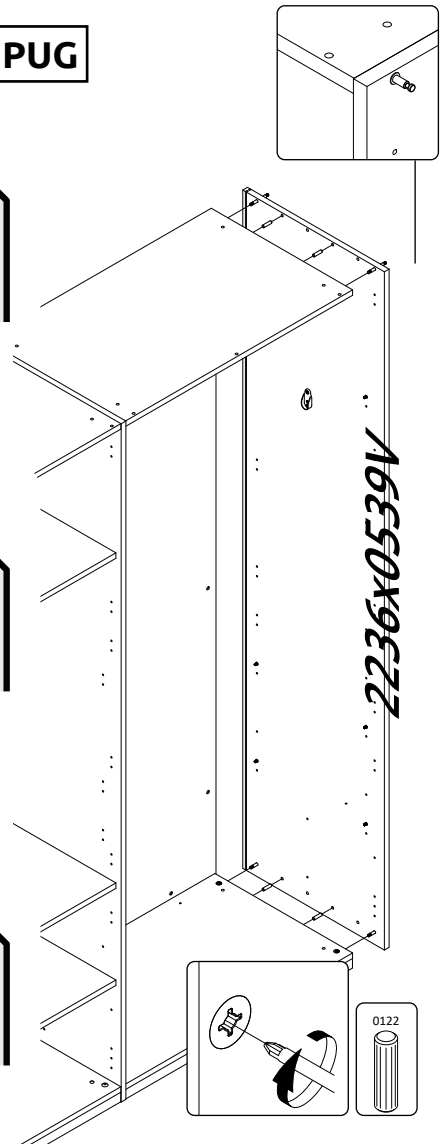
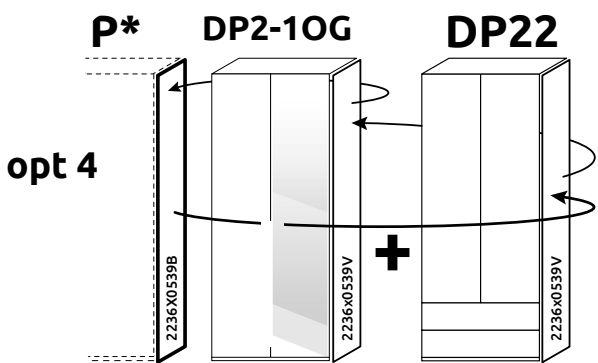
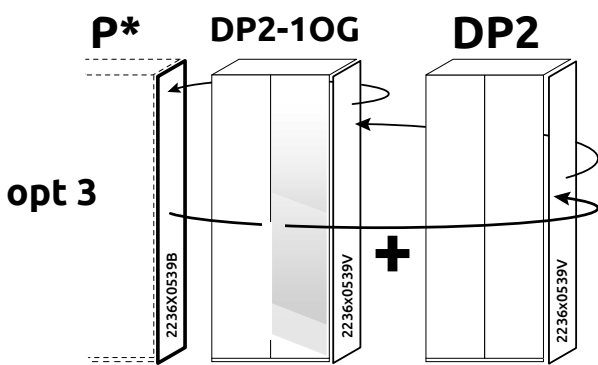
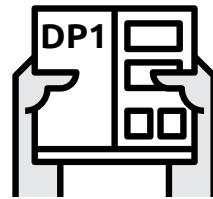

0122

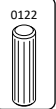

6

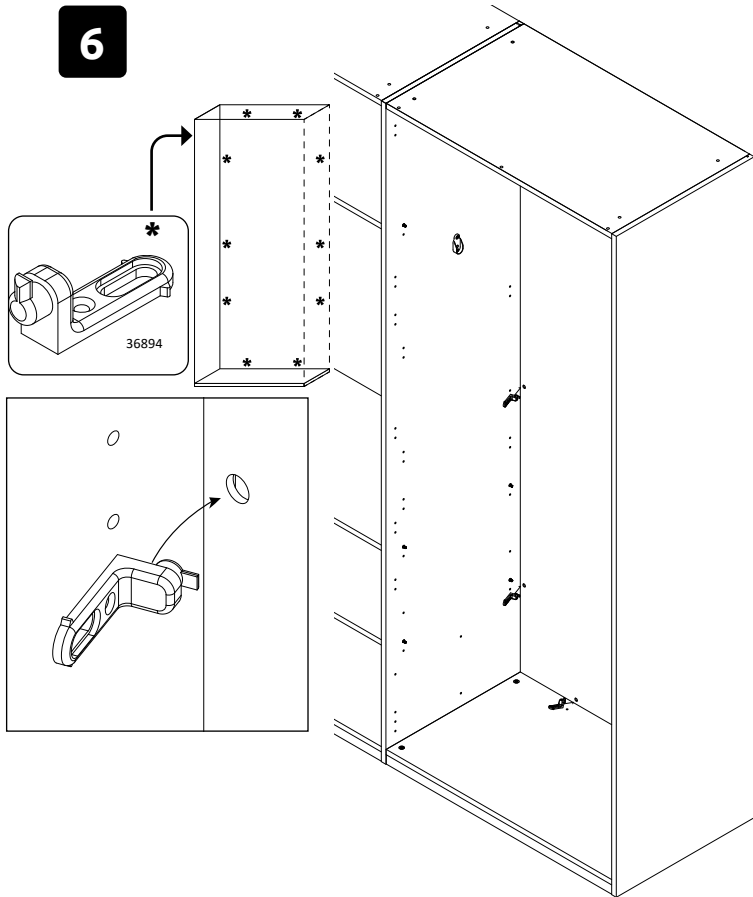

7

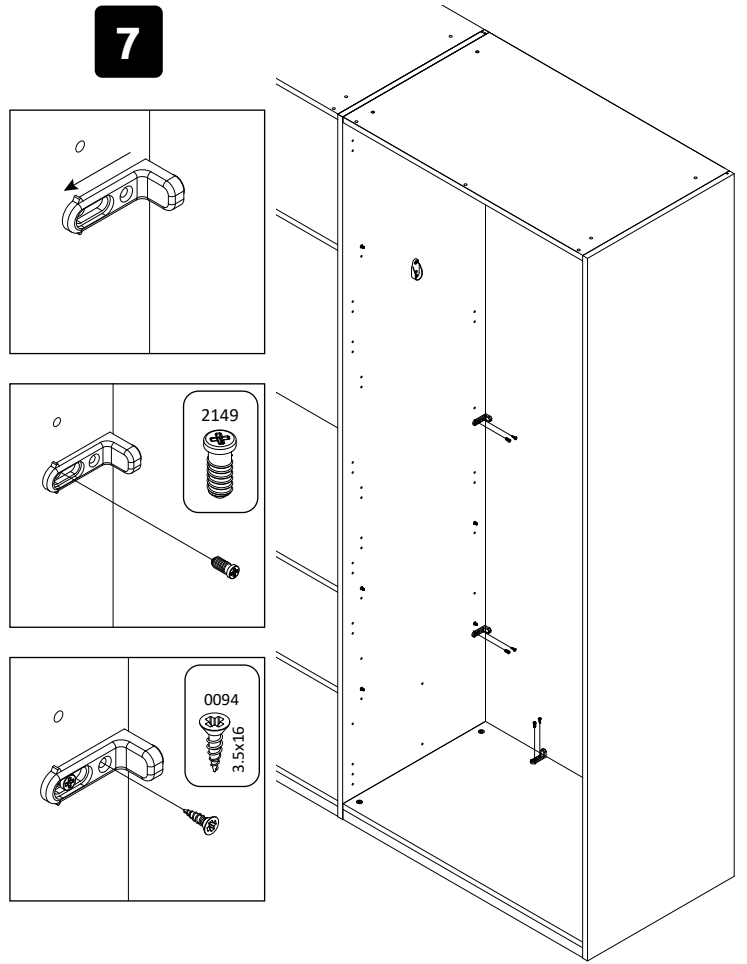

8

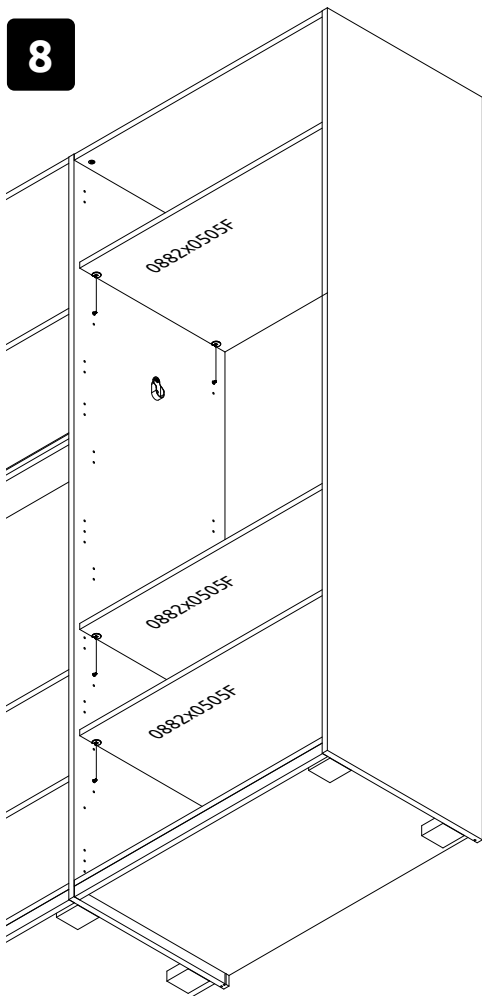

9

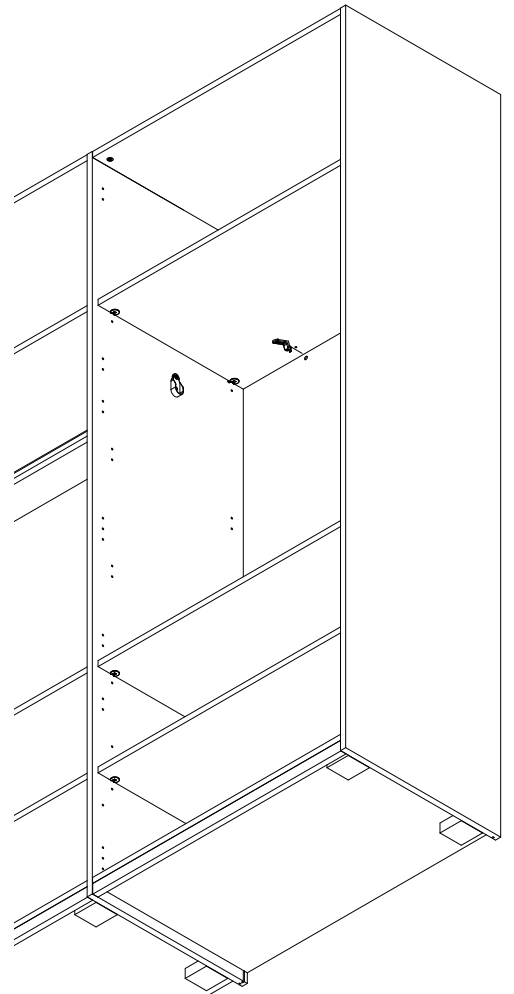
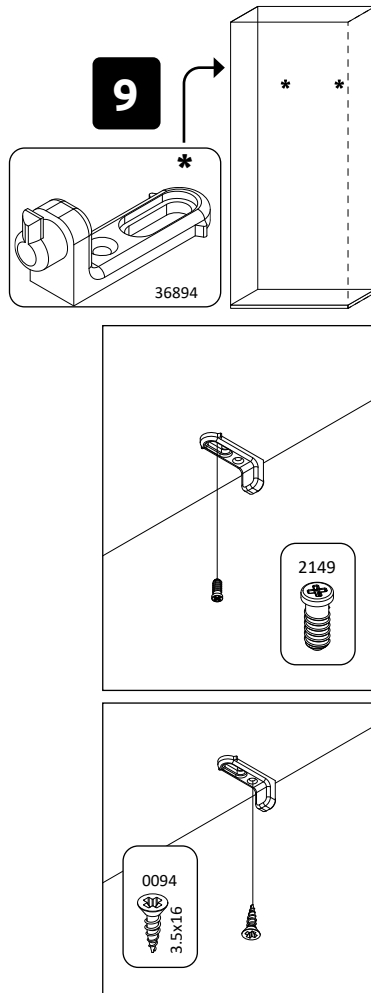

10

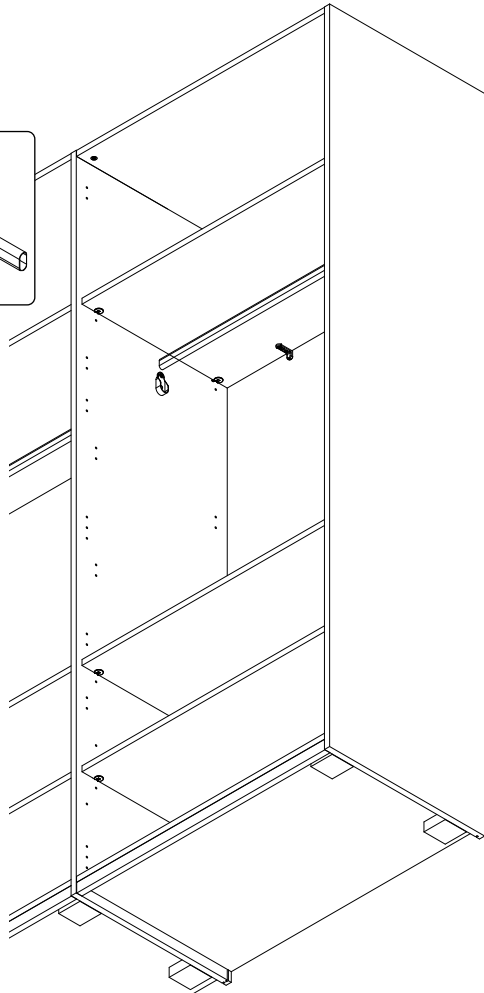
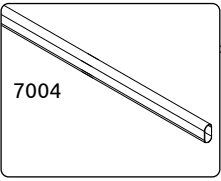

11

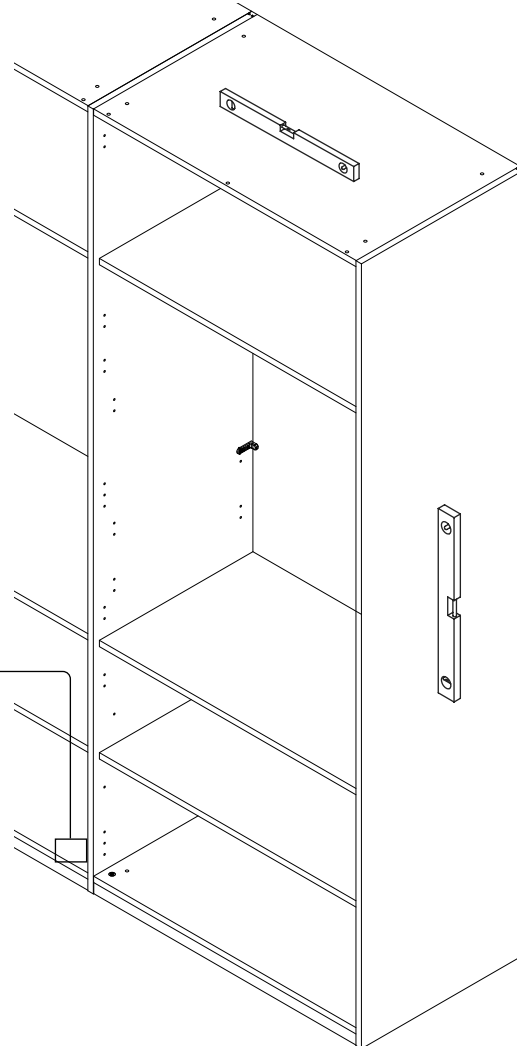
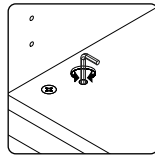
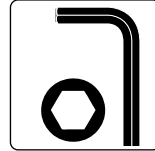
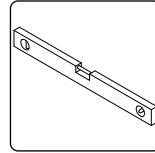

12

*opt P+DP2

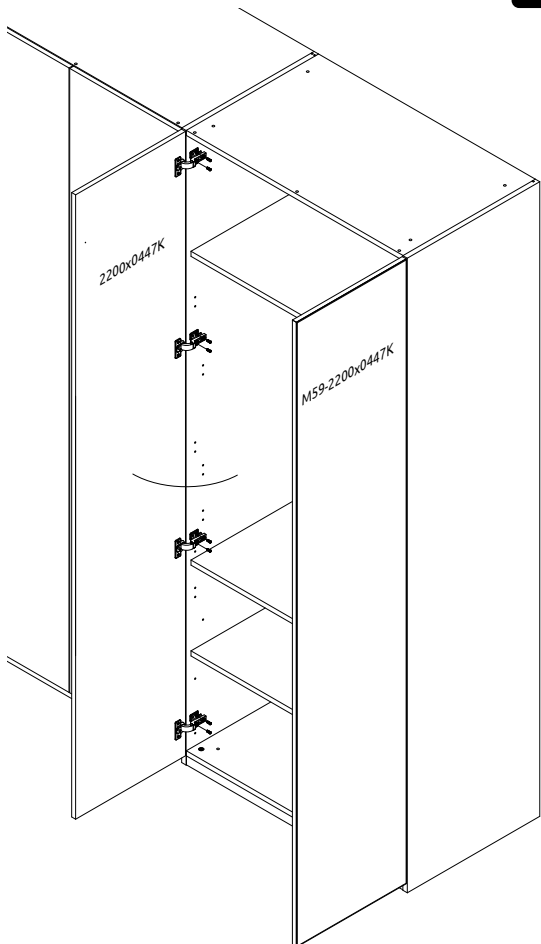
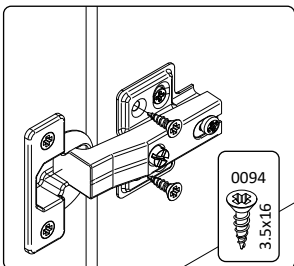
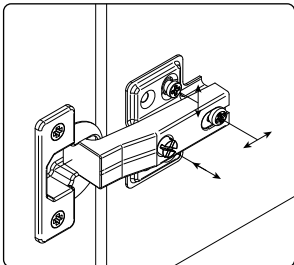
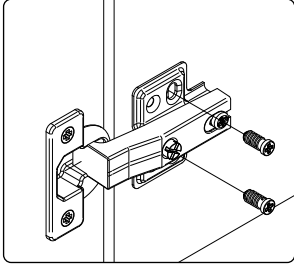

13

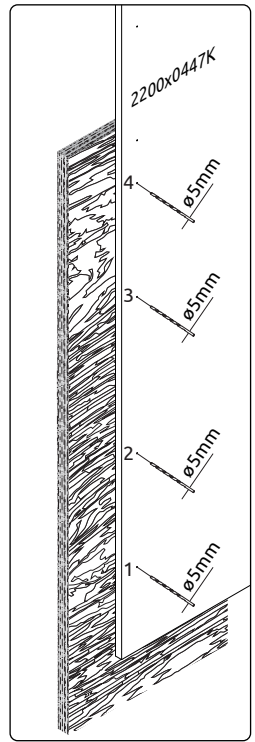

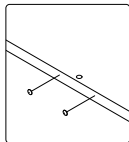
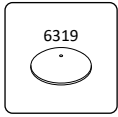

14

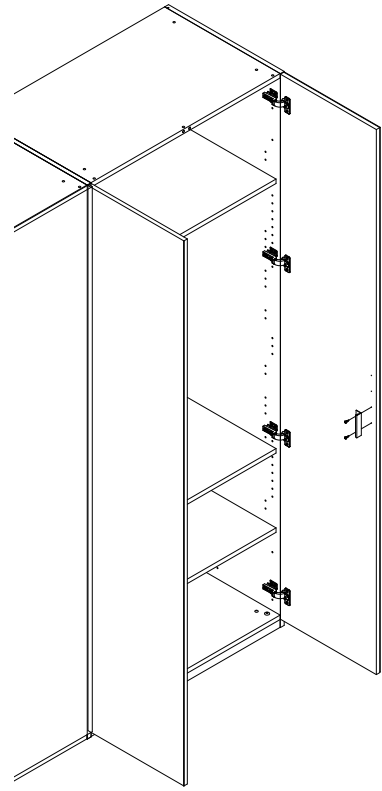

15

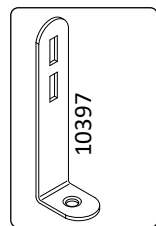
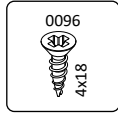
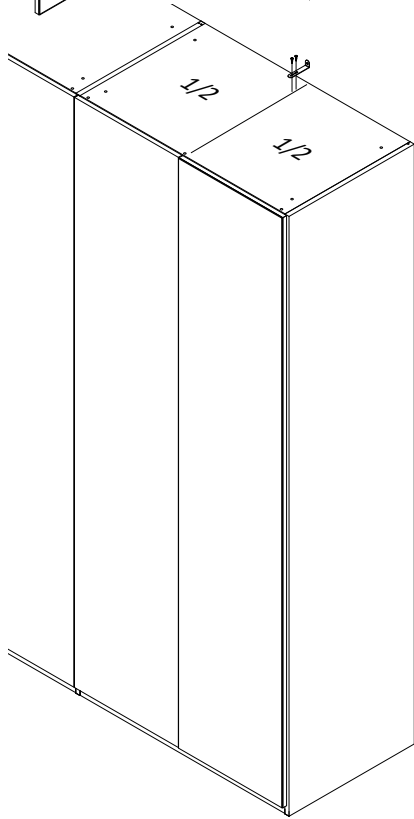
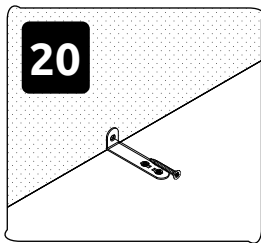
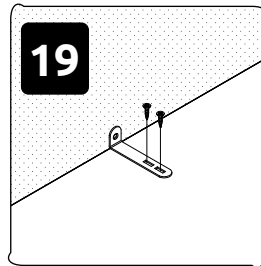
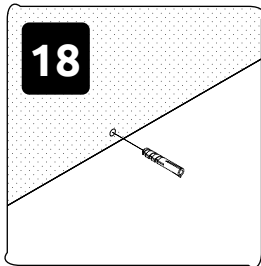
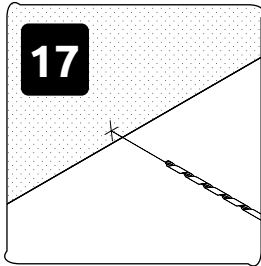
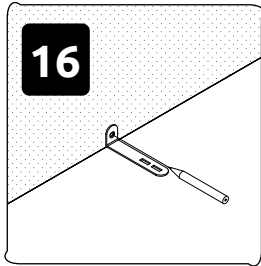
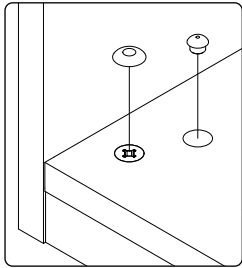
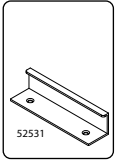
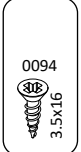

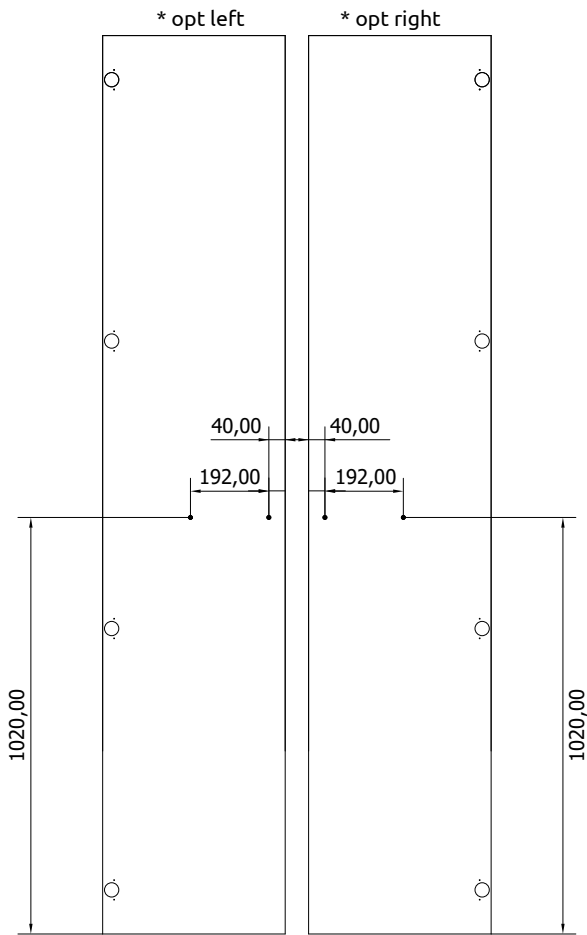

*** OPT**

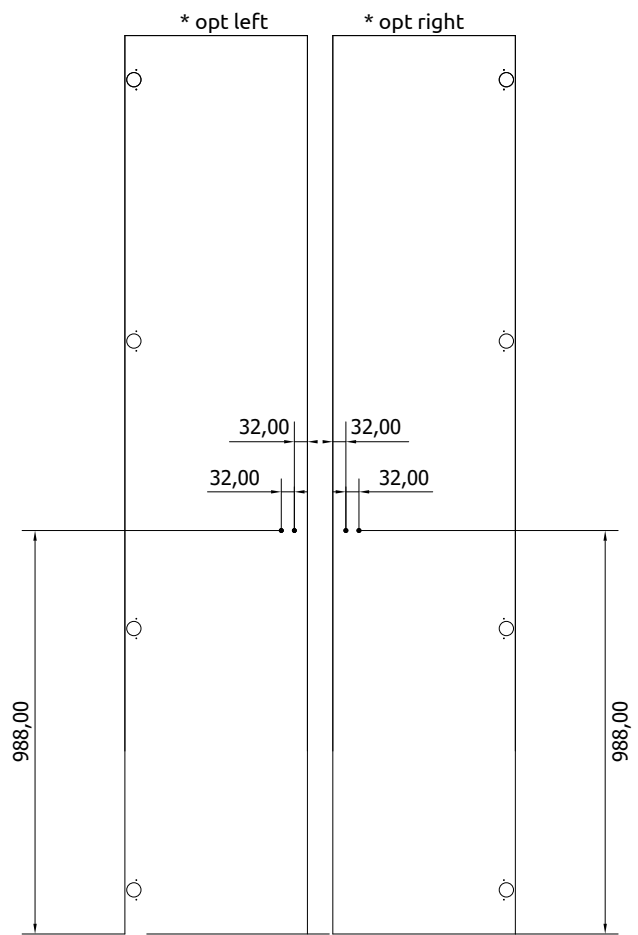
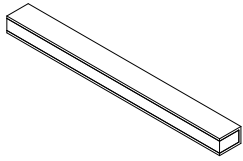

*** OPT**

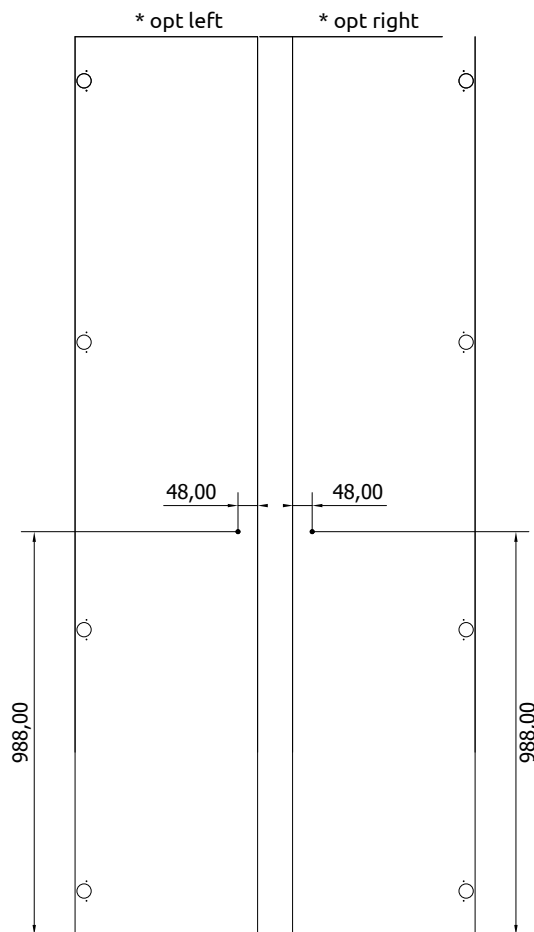
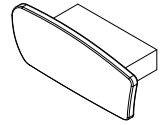

*** OPT**

