

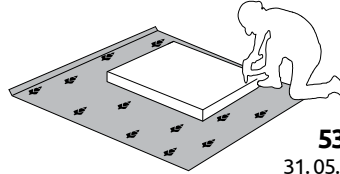

IMPORTANT - READ CAREFULLY - RETAIN FOR FUTURE REFERENCE
WICHTIG - SORGFÄLTIG LESEN UND AUFBEWAHREN

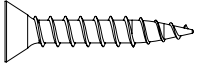

53935
31.05.2022

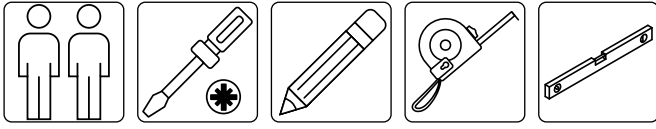
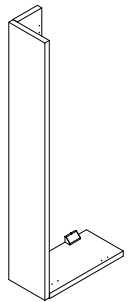
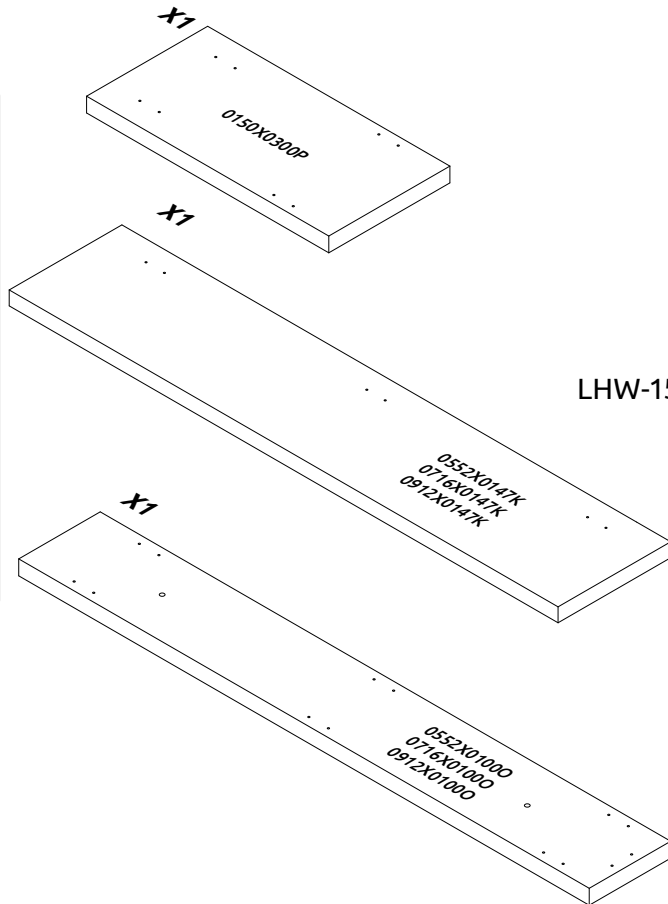
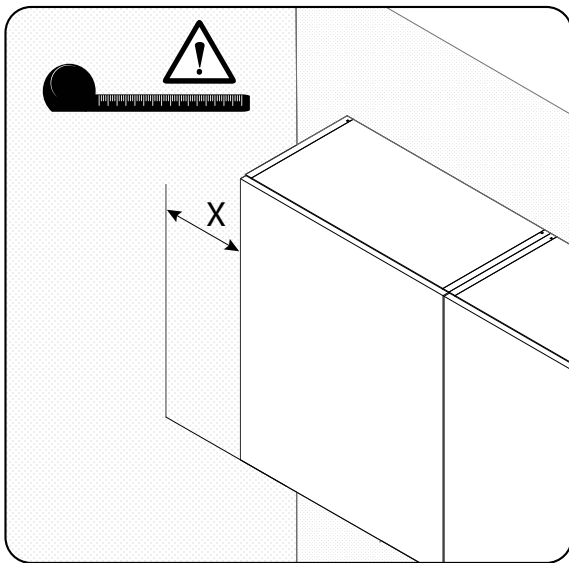
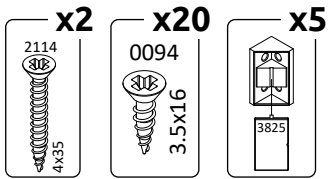

PE-V9
LHW-150X910X320

