

IMPORTANT – READ CAREFULLY – RETAIN FOR FUTURE REFERENCE

WICHTIG – SORGFÄLTIG LESEN UND AUFBEWAHREN

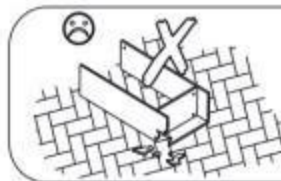

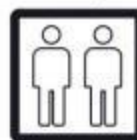

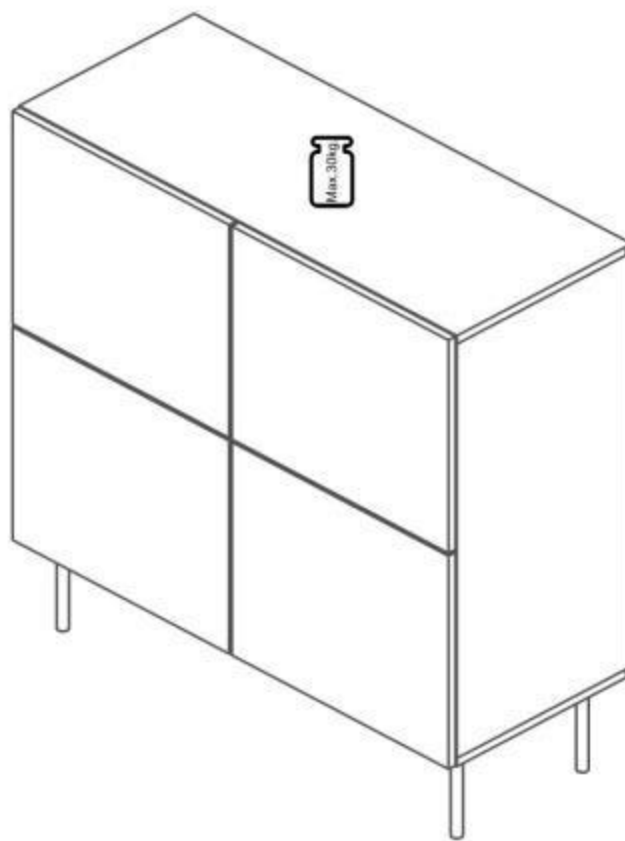

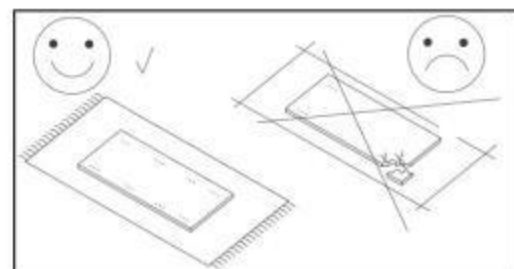
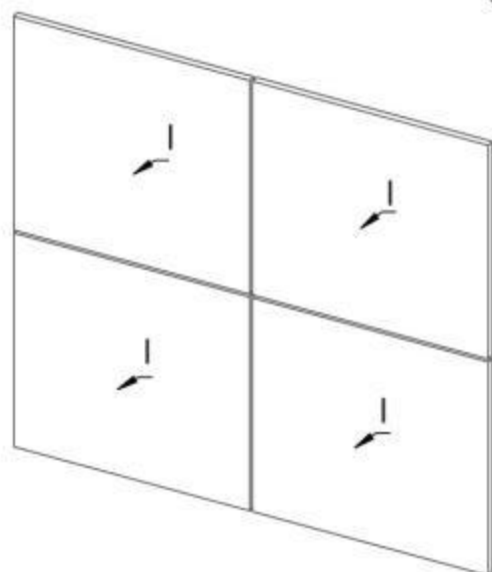
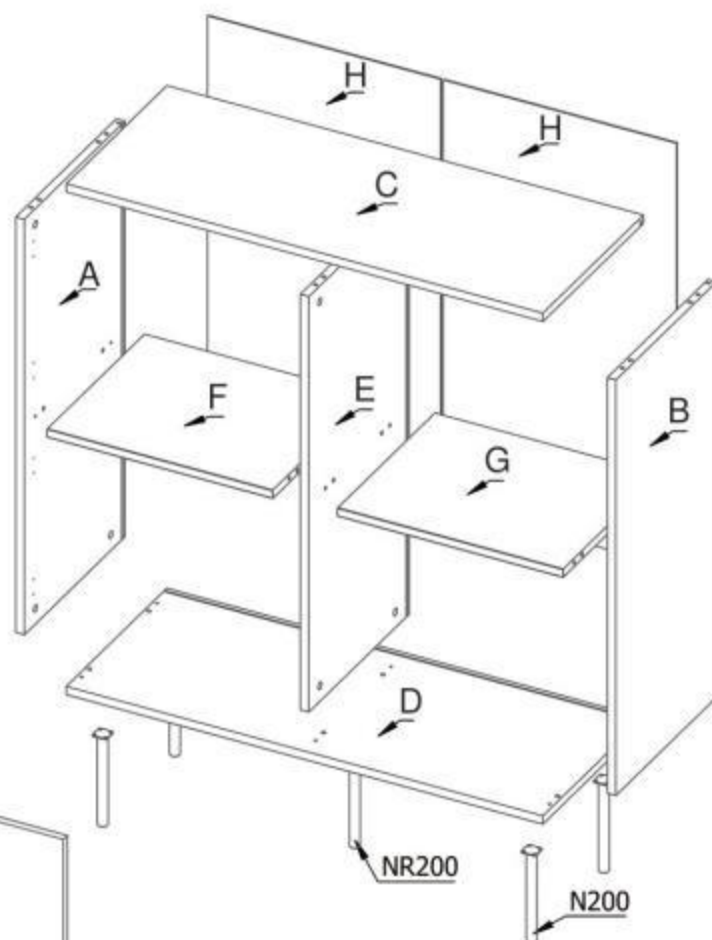
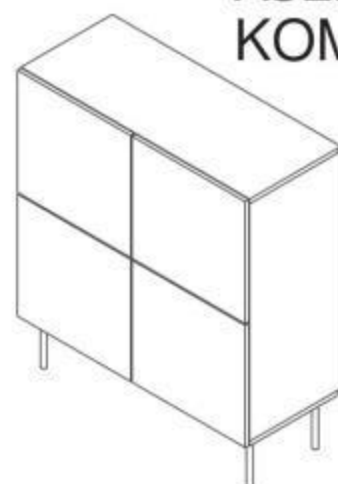
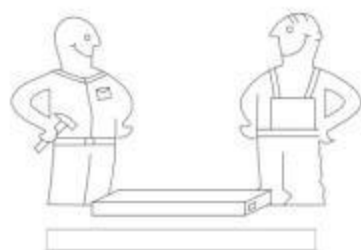
ASENSIO KOM 4D



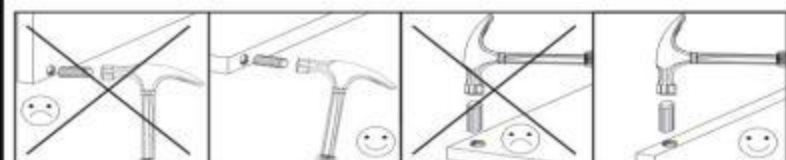



J 16	K 16	L 20	M 8	L 8	N 20
O 12	P 2	R 2	S 16	T 4	W 20

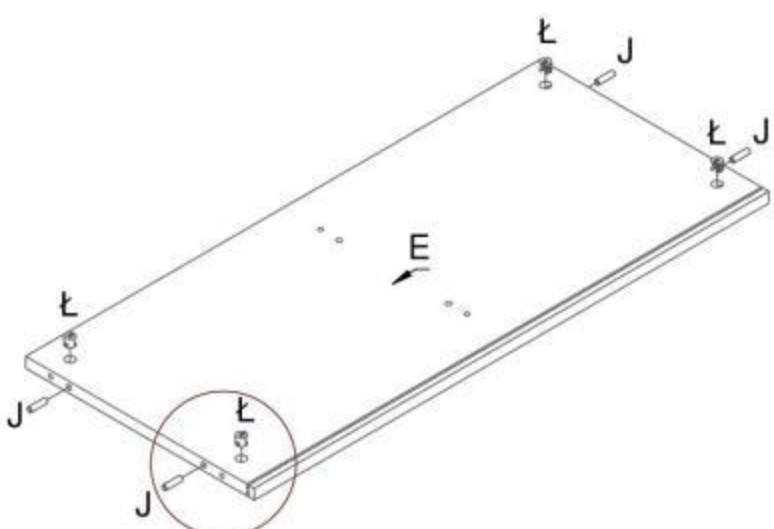
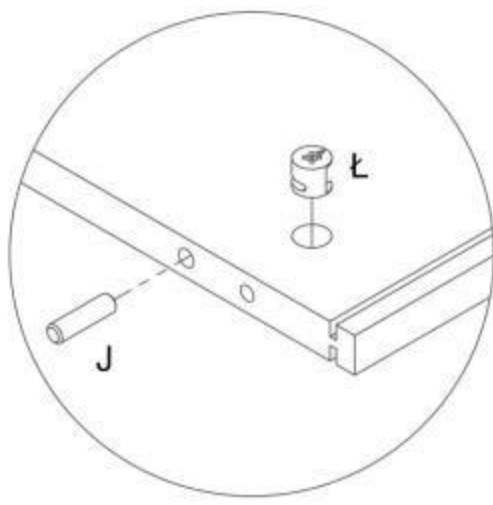
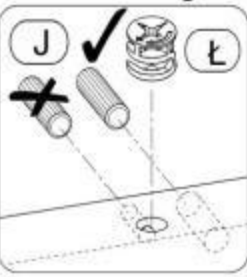
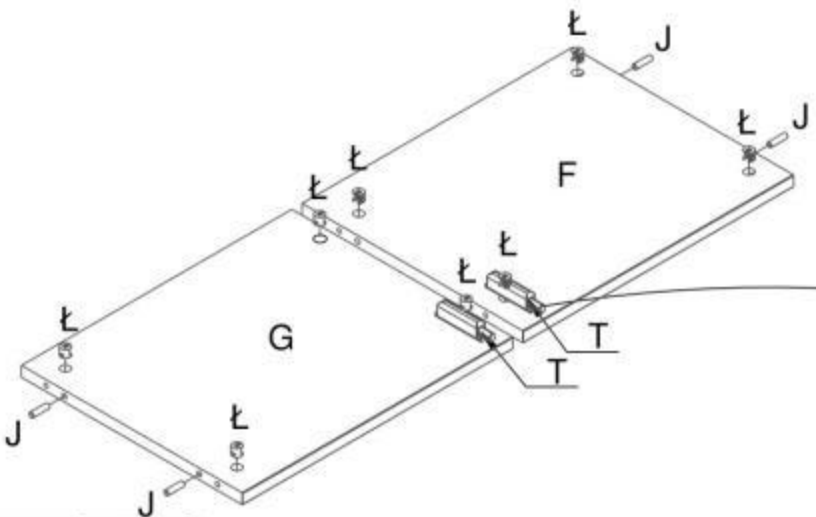
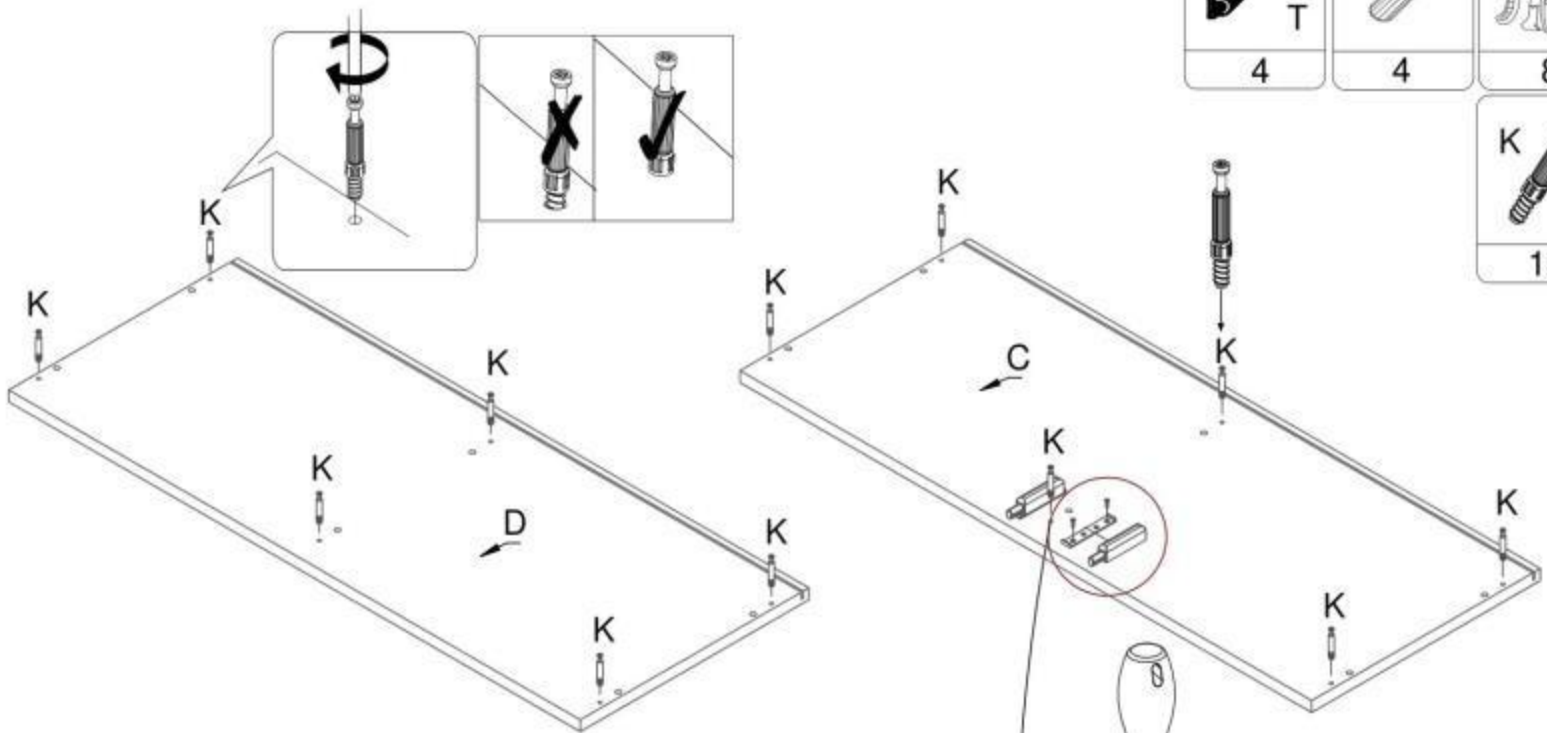

- | | | |
|---|--|--|
|  T |  J |  L |
| 4 | 4 | 8 |
|  K | | |
| 12 | | |



- | | |
|---|---|
|  J |  L |
| 4 | 4 |

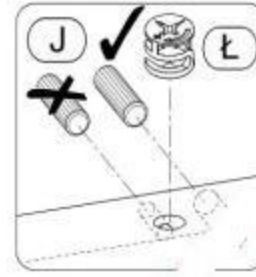

K	L	L	J
			
4	8	8	8

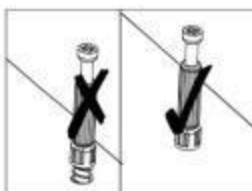
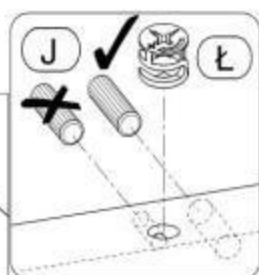
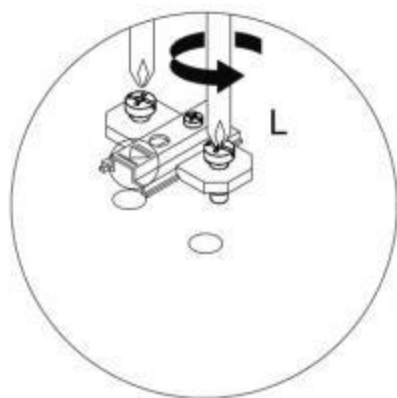
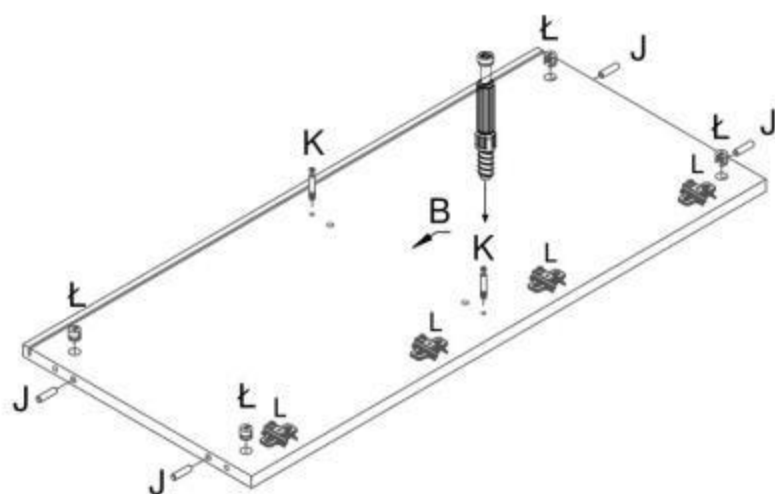
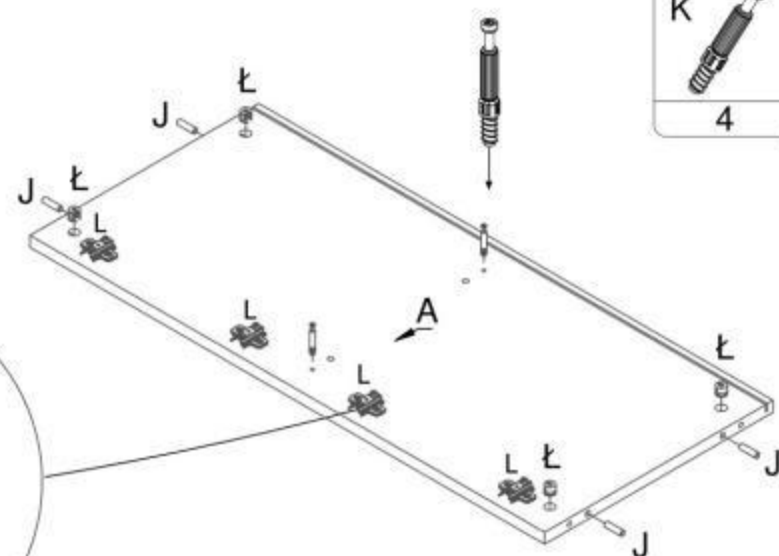

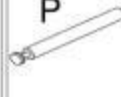

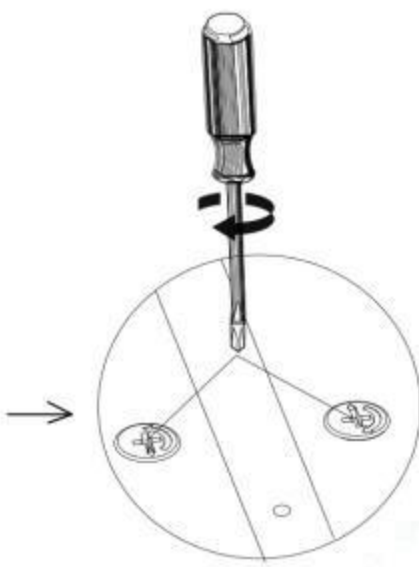
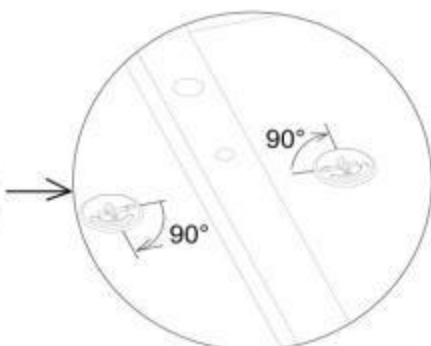
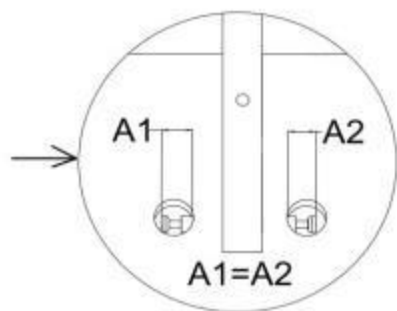
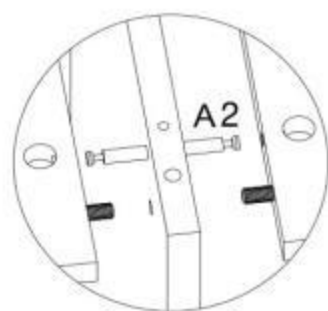
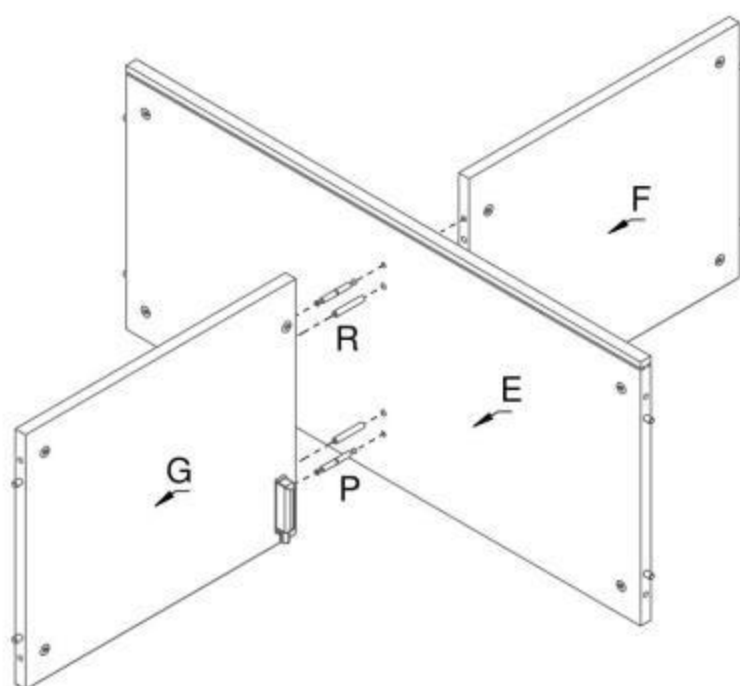
R	P
	
2	2

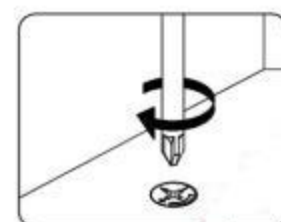
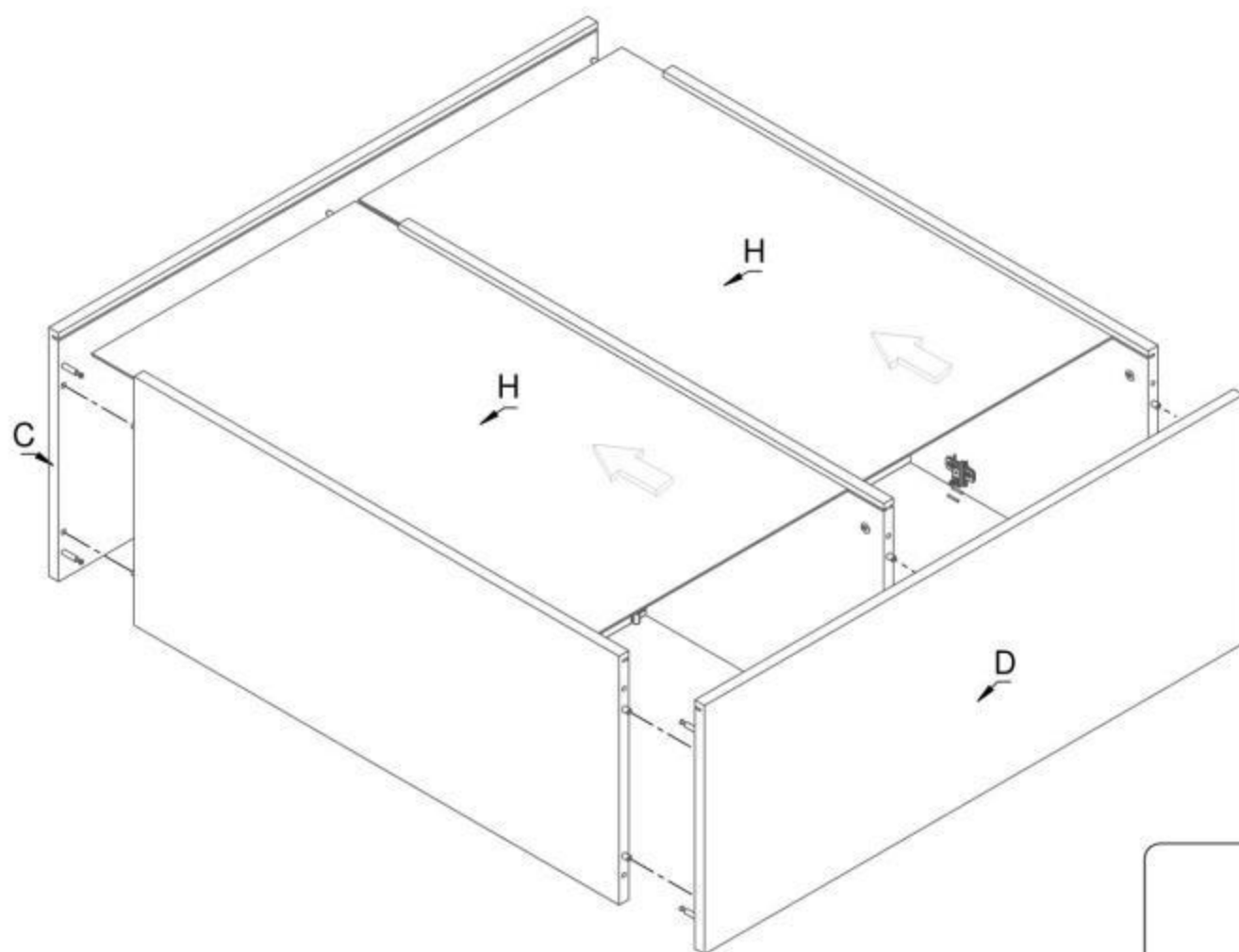
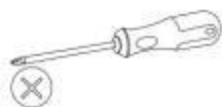
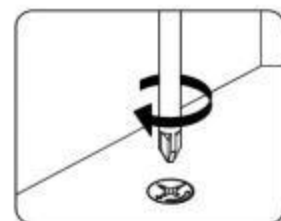
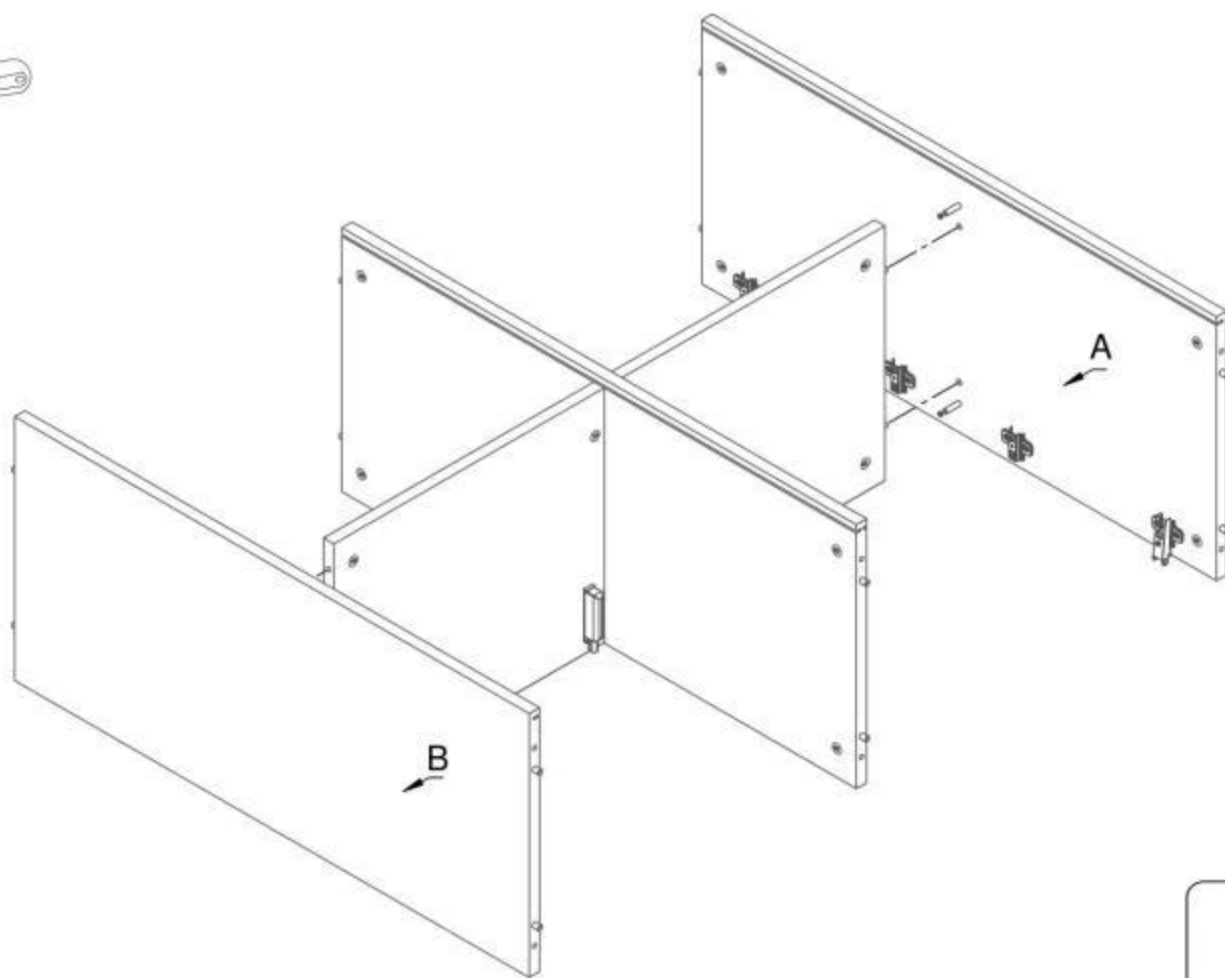
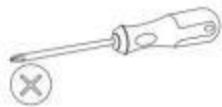

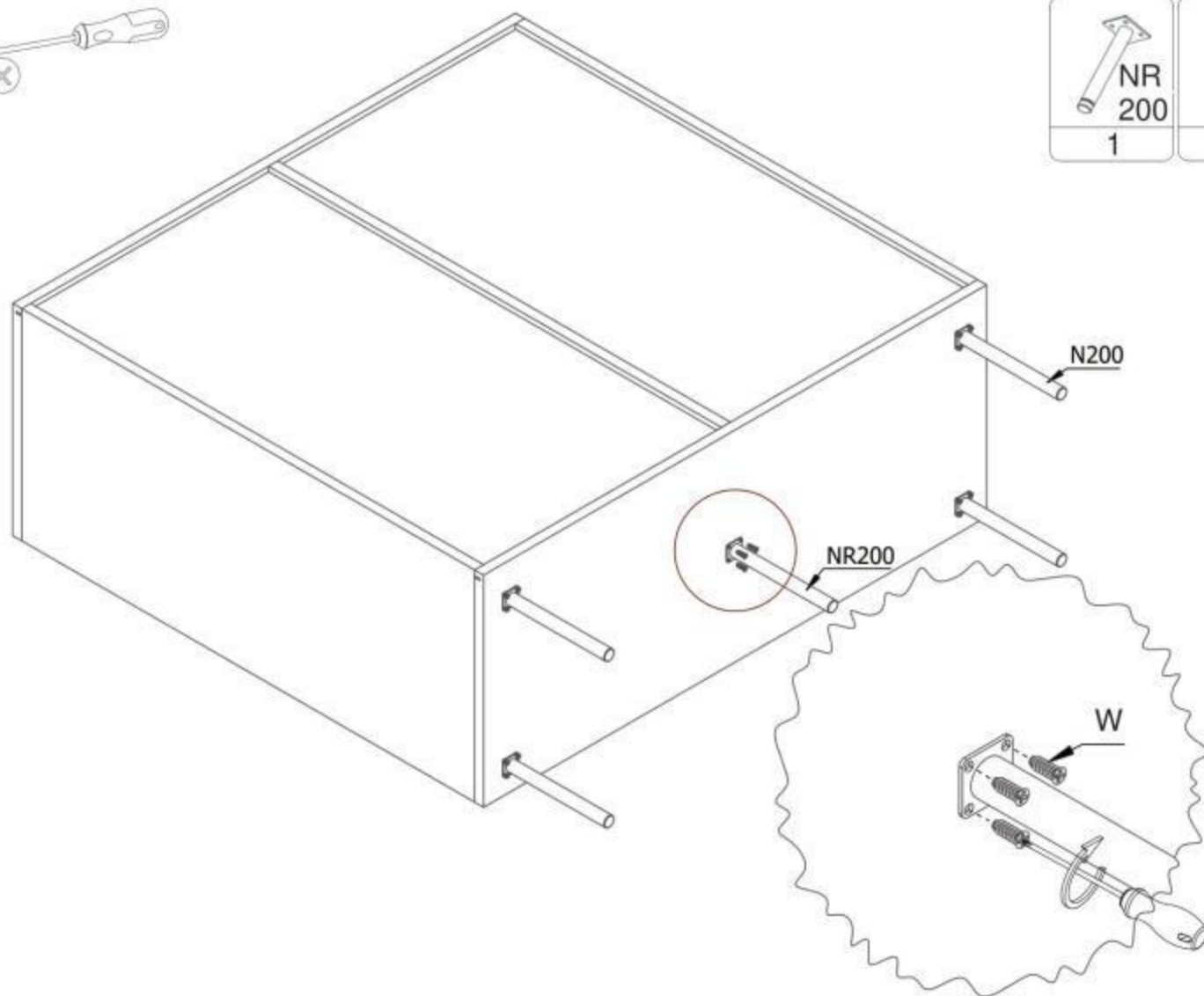
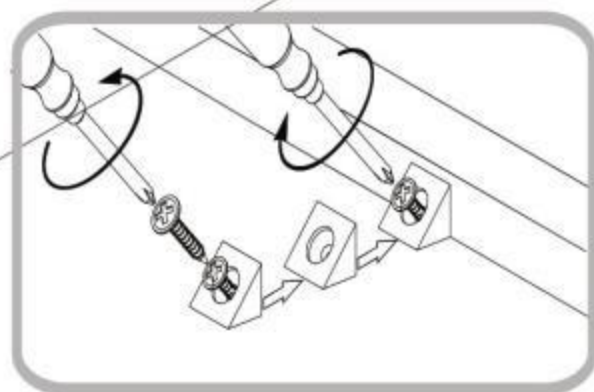
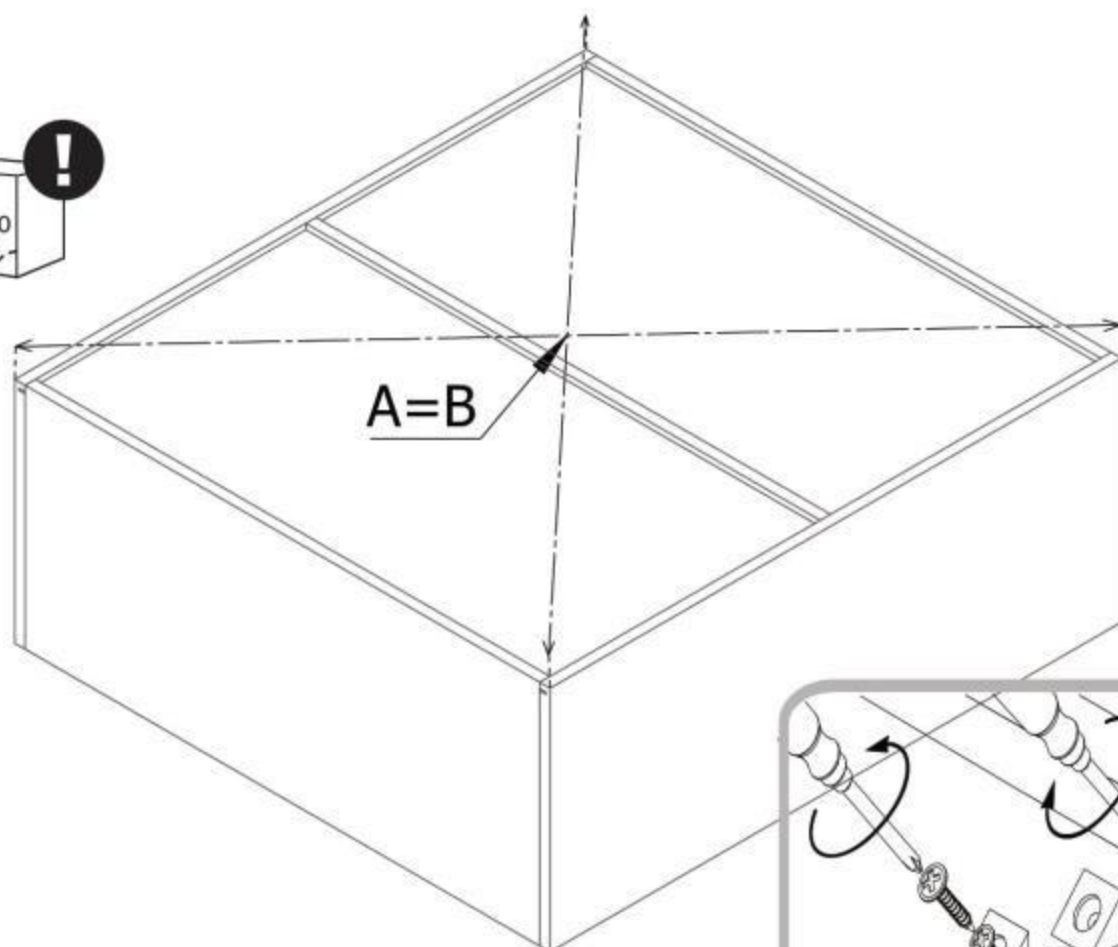
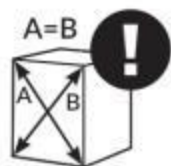



 NR 200	 W	 N200
1	20	4

S  16	M  8
--	--

