

∅10 mm

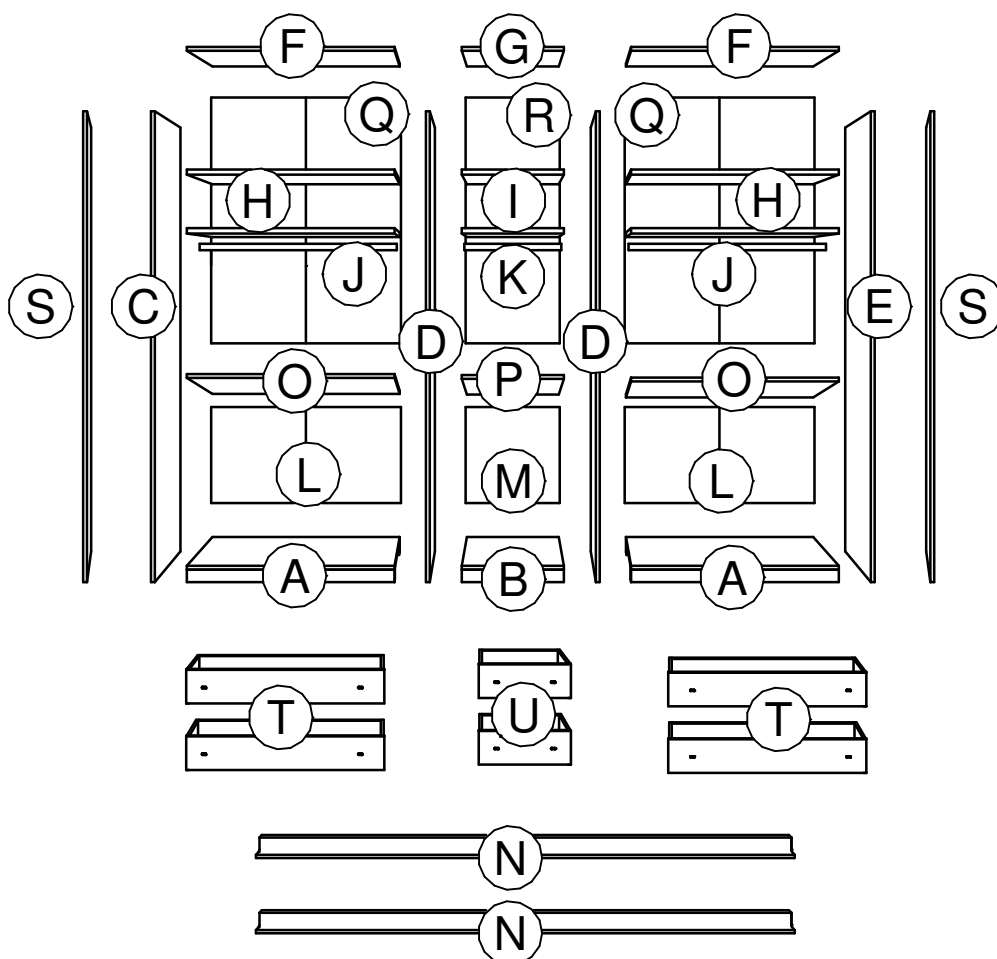

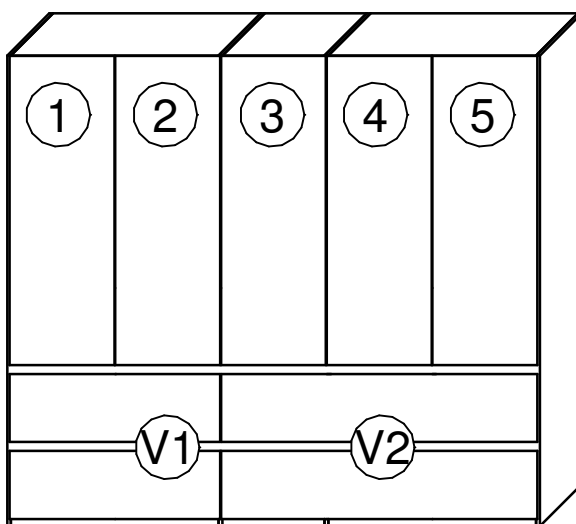

1	2	3

V2

480	976
-----	-----

1	2	3	4

V1 V1

976	976
-----	-----

1	2	3	4	5

V1 V2

976	480	976
-----	-----	-----

1	2	3	4	5	6

V1 V1 V1

976	976	976
-----	-----	-----

1.

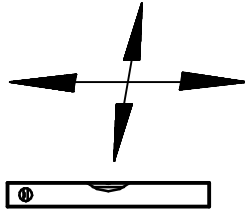

1

641.0227.000  
12 mm



2

1

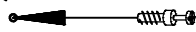
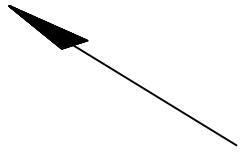

2

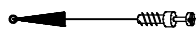

2



1

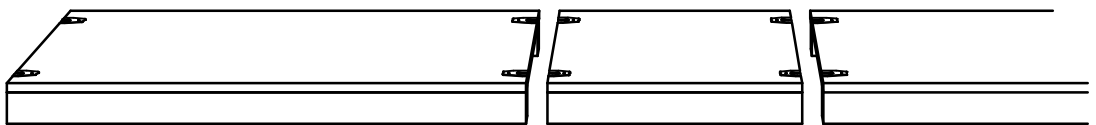
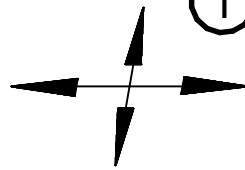

2.

641.0226.000

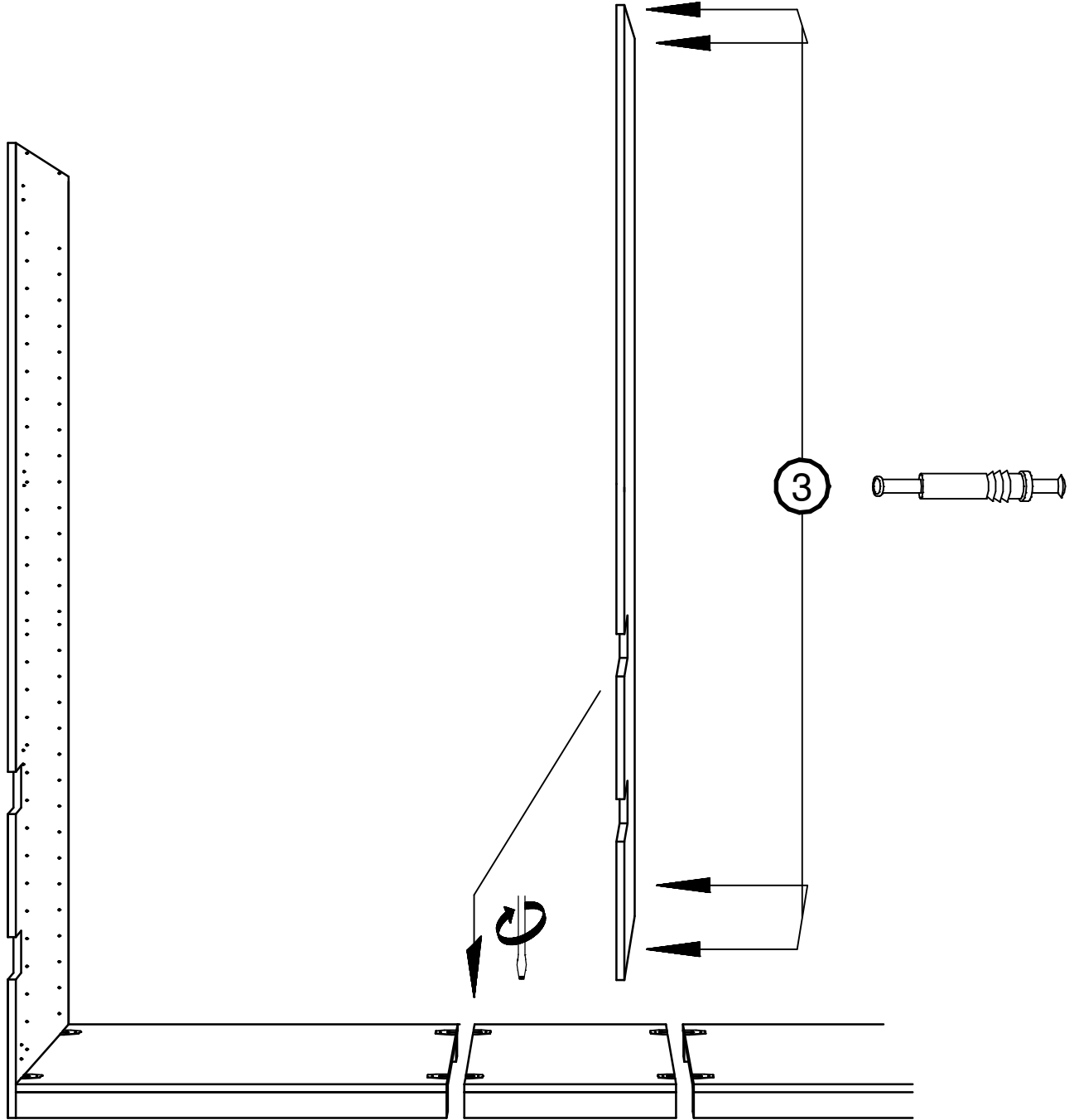
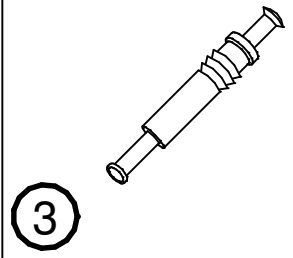

3.

641.0548.000

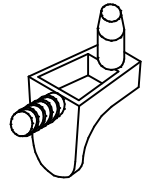

4

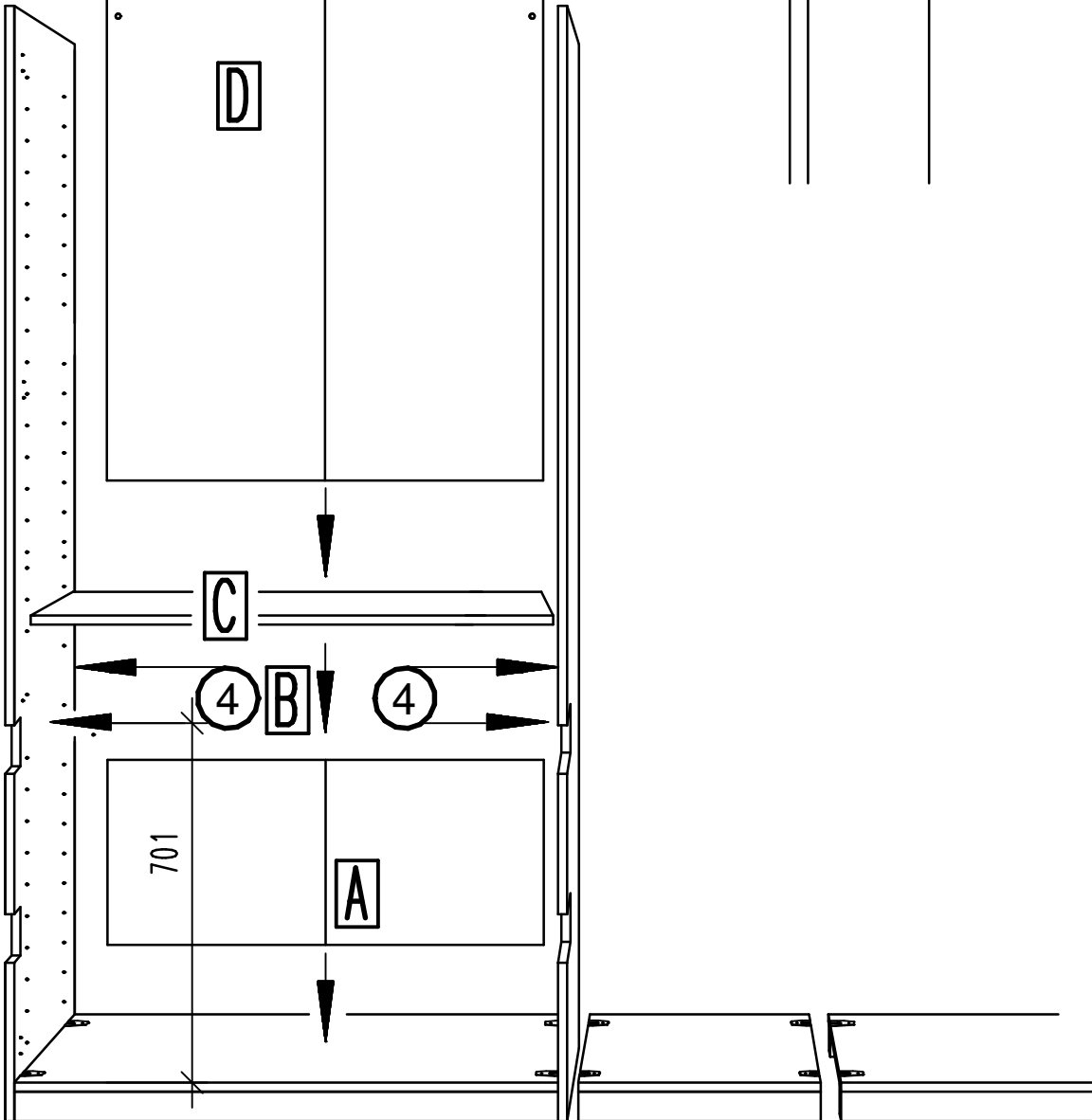
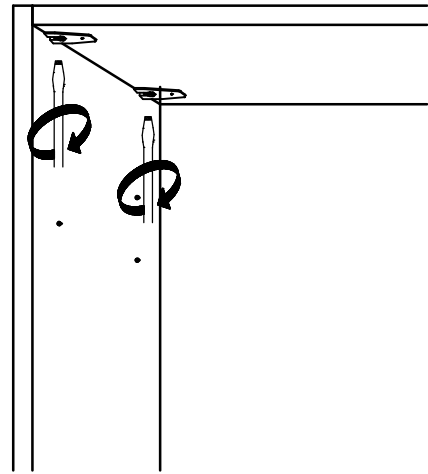
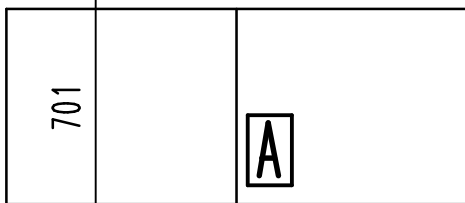
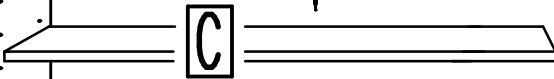
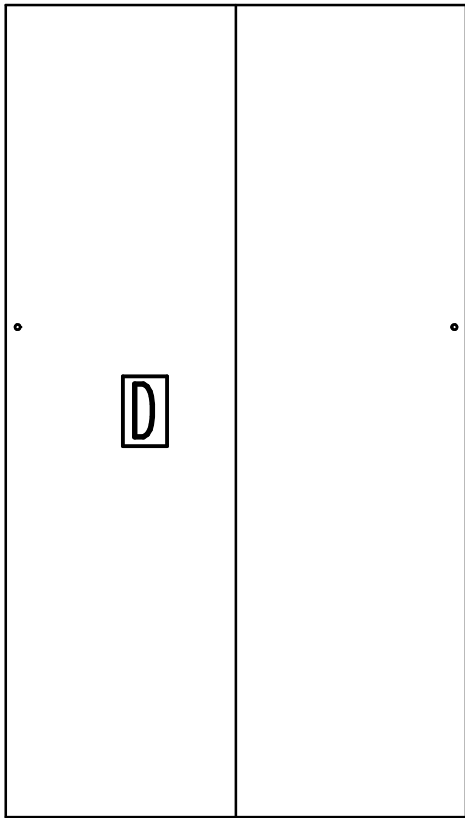
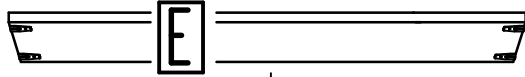

4.

631.1472.000  
3,5 x 15 mm



5

631.1266.000  
6,3 x 11 mm



6

621.2930.000

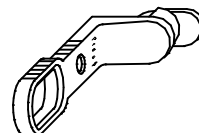

7

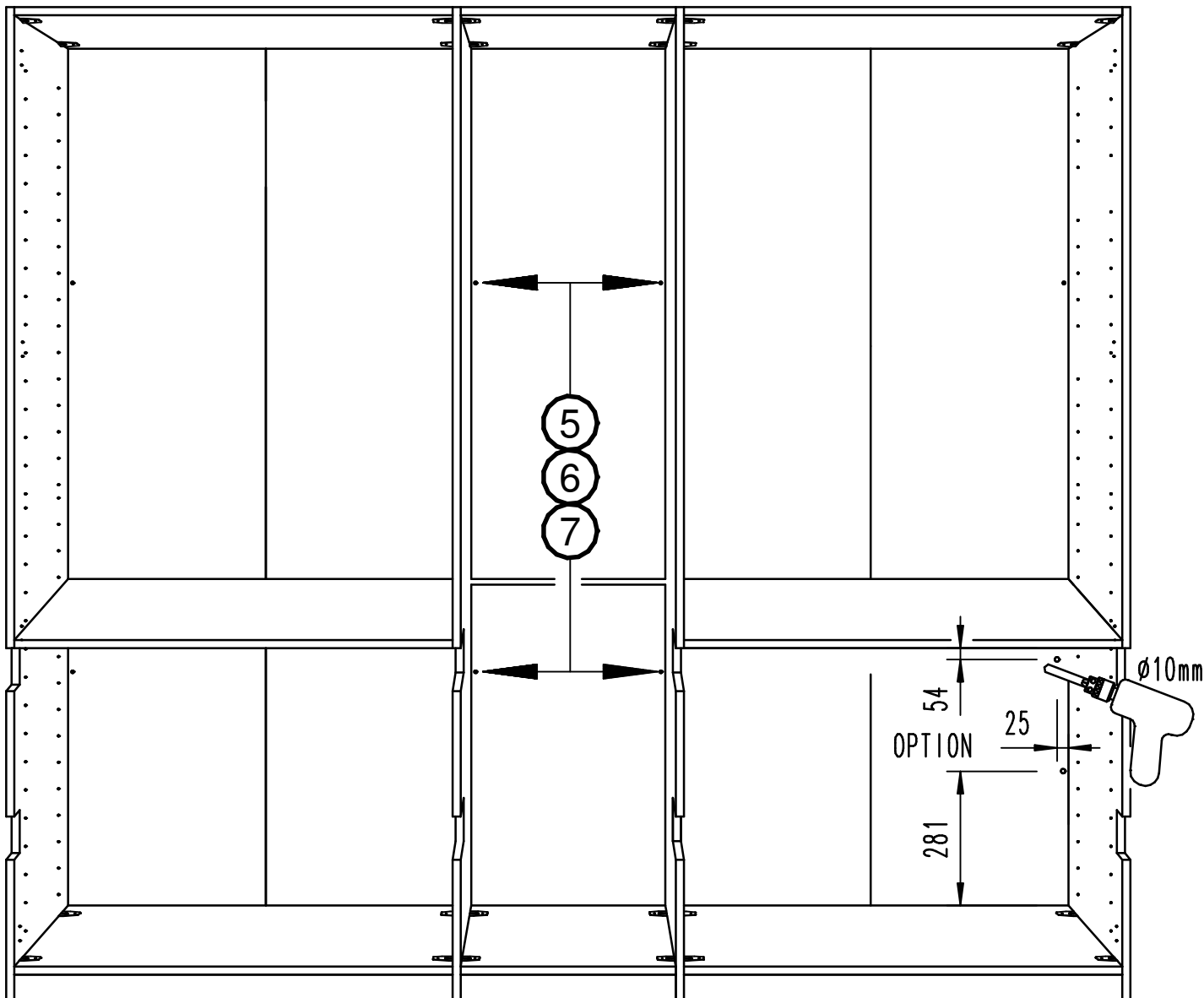
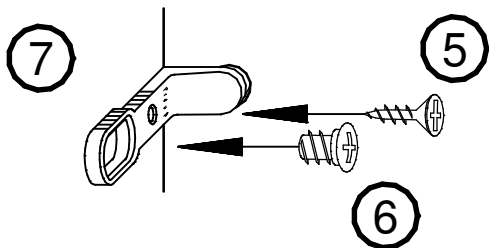

5.

632.0526.000  
3 x 20 mm



8

641.0286.000



9

2 x

642.9024.000

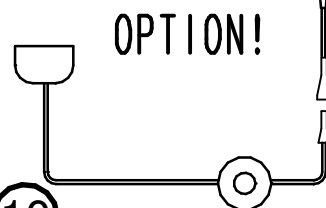

10

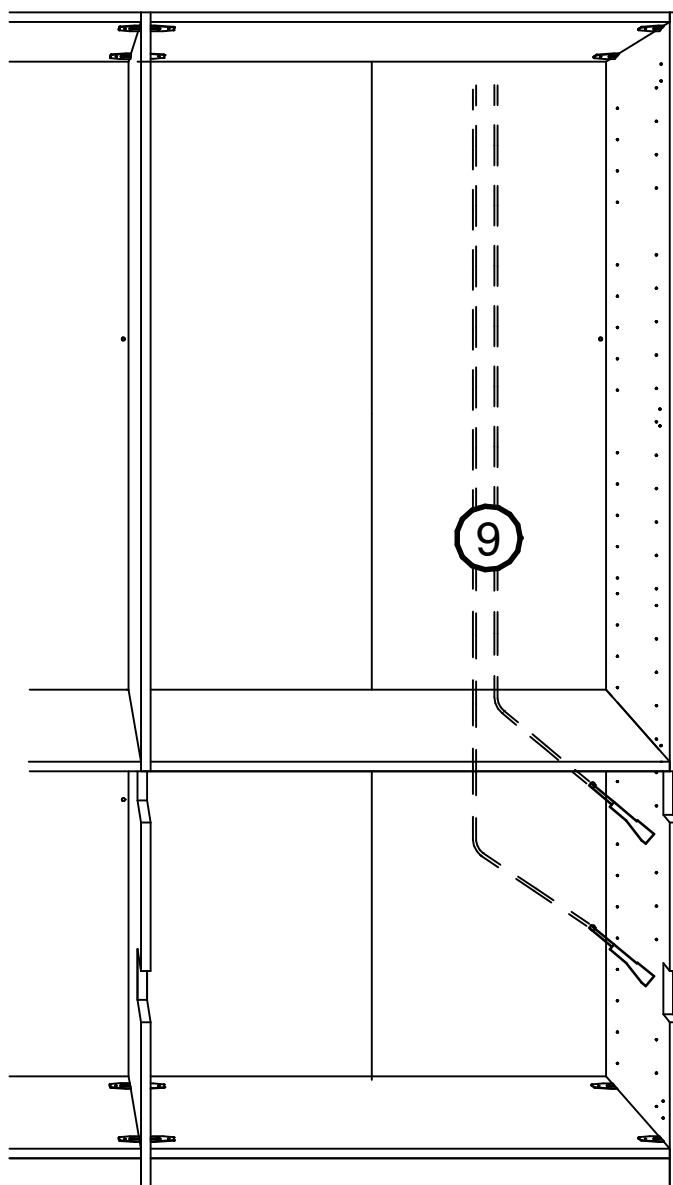
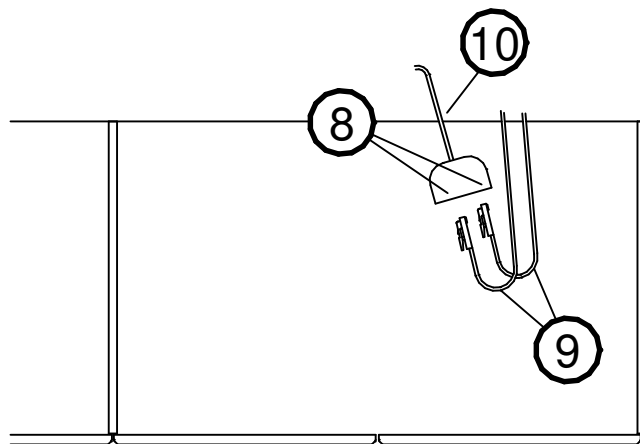

641.0204.000

632.0038.000

4 x 14 mm

621.0067.000

632.0517.000

M6 x 30 mm

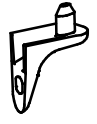

11



12

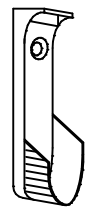

13

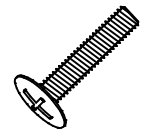

14

6.

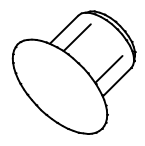

15

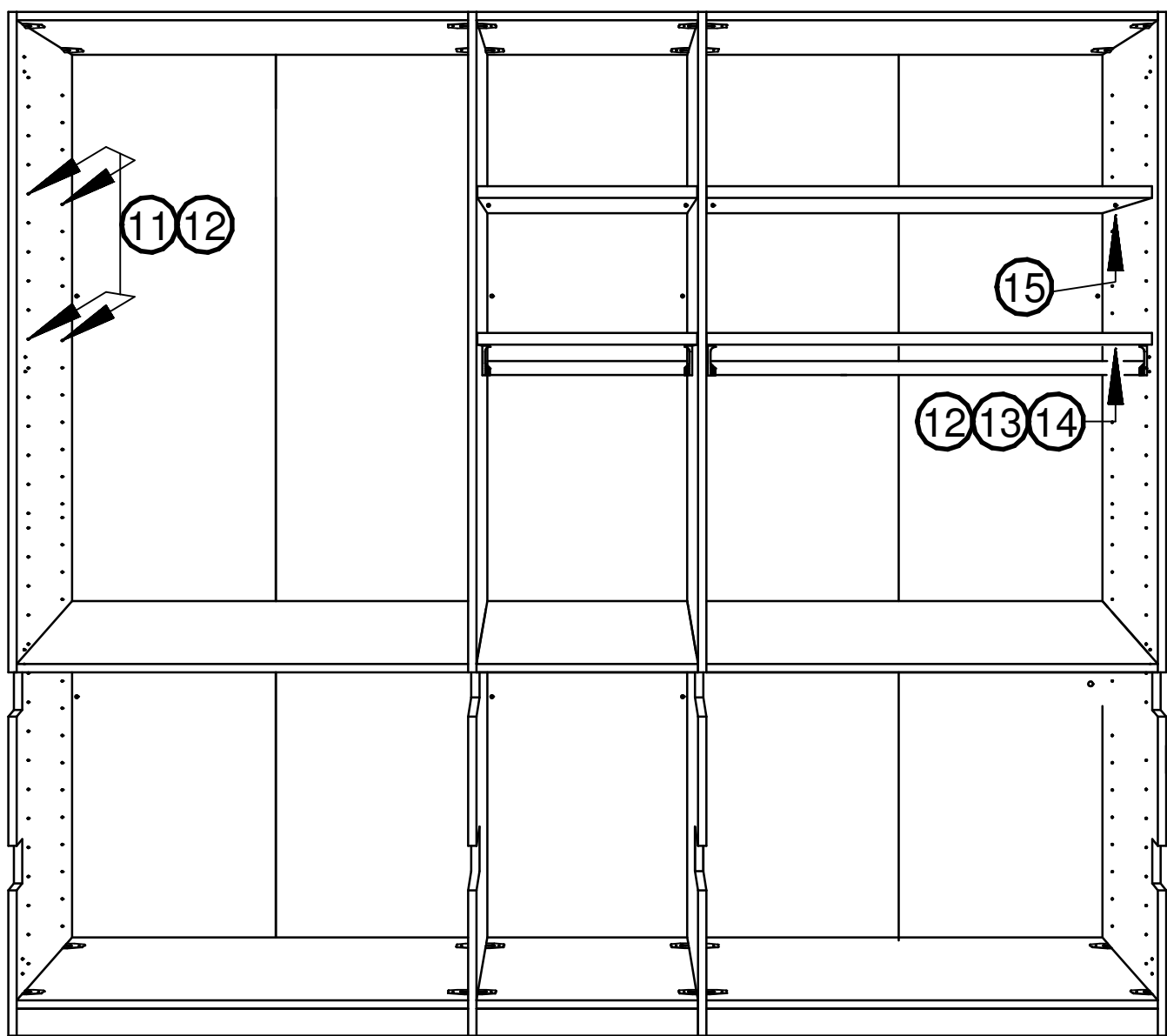



7.

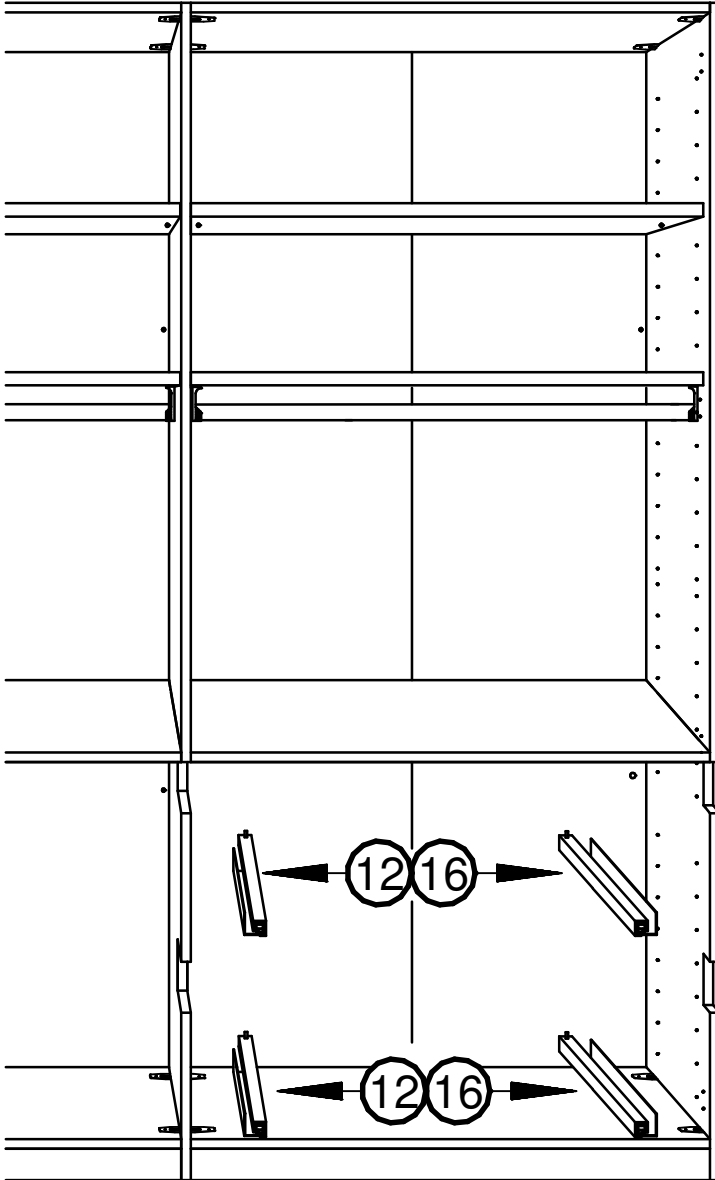

632.0545.000  
6,3 x 9 mm

16



632.0038.000  
4 x 14 mm

12

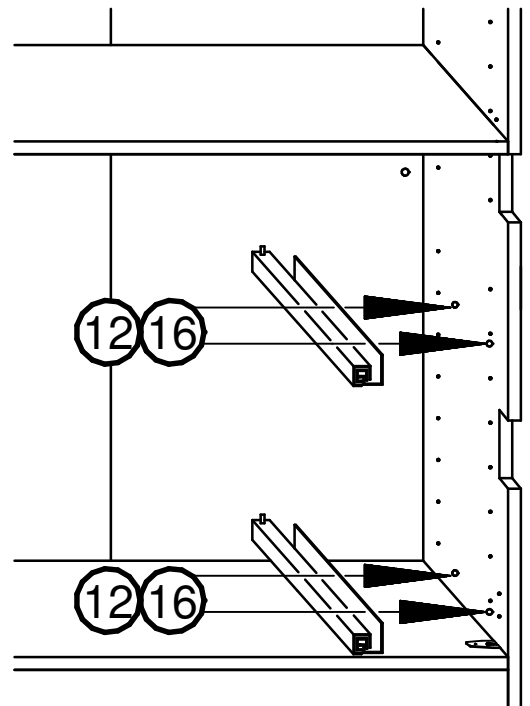
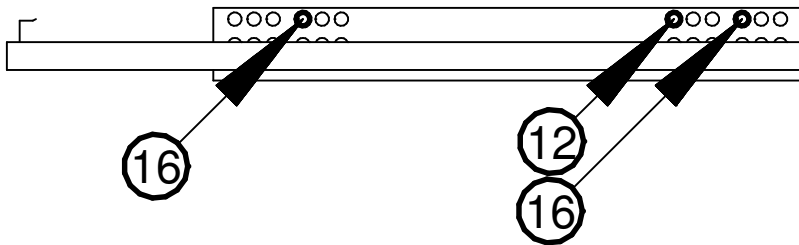

8.

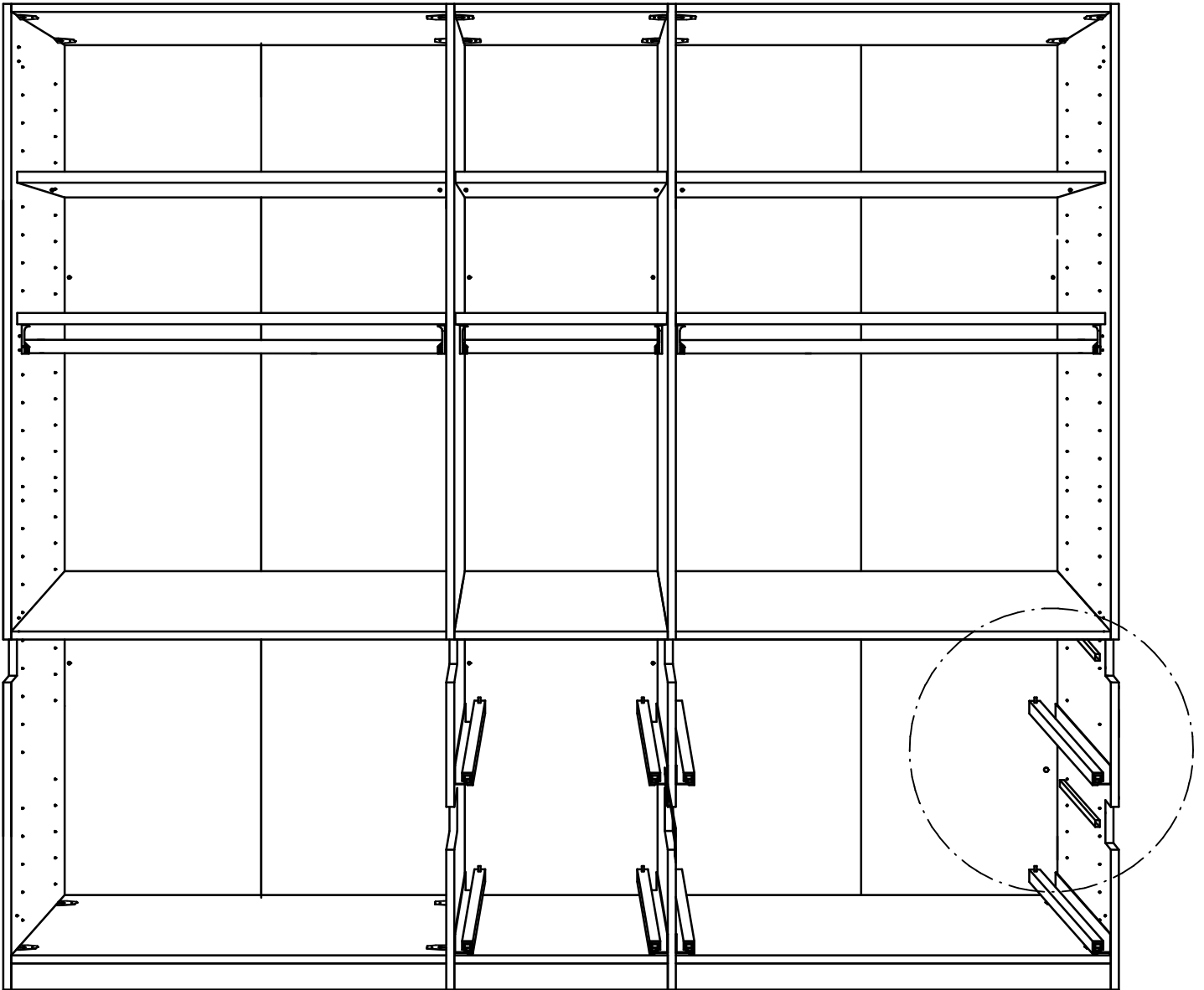

OPTION

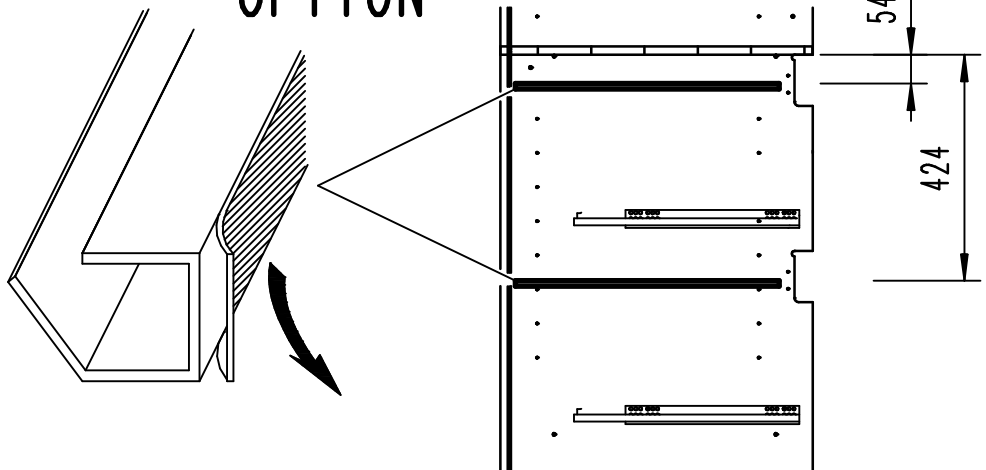

641.0381.000

631.1472.000

3,5 x 15 mm

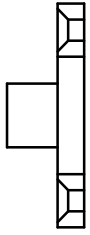

17

5

9.

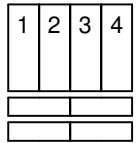

V1 V1

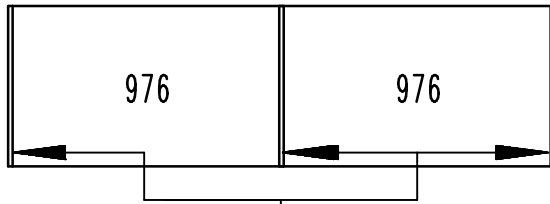

17 5

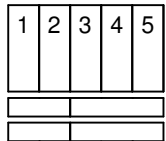

V1 V2

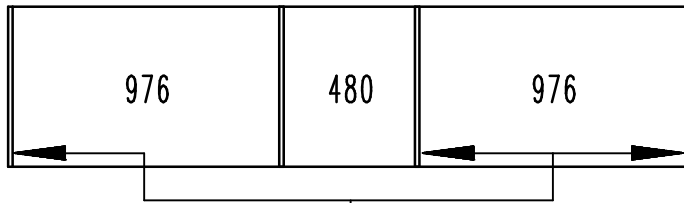

17 5

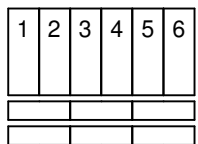

V1 V1 V1

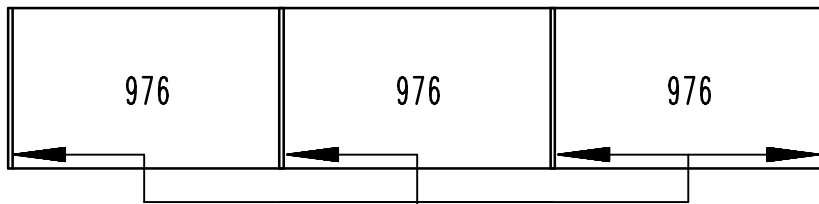

17 5

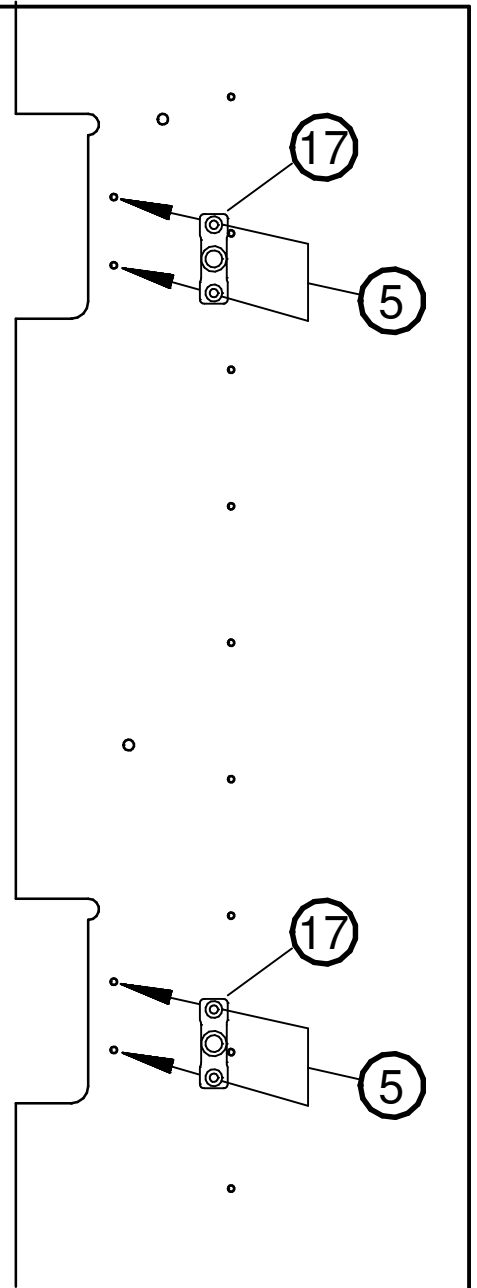

10.

631.1472.000  
3,5 x 15 mm

641.0380.000

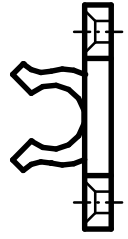

5

18

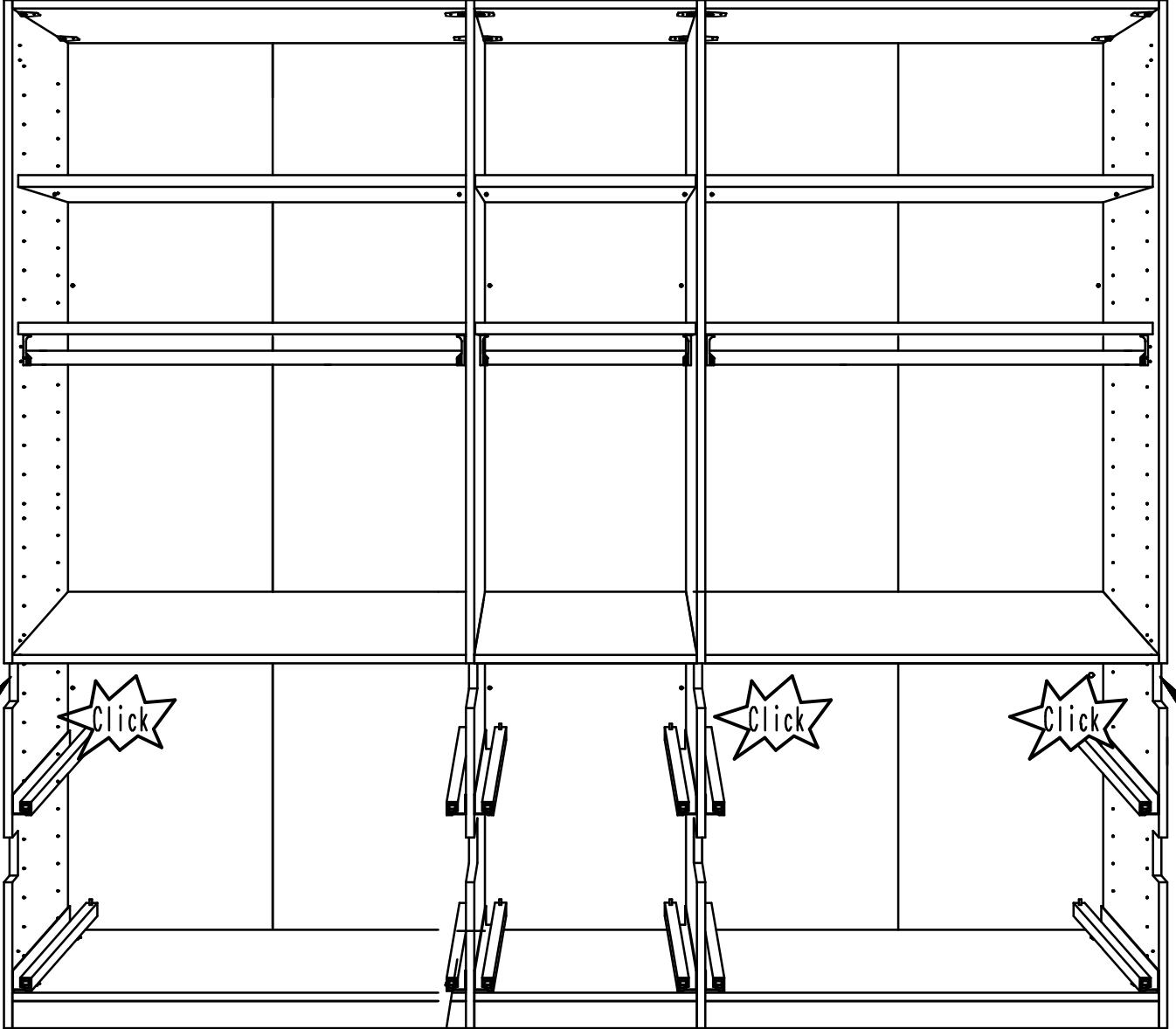

5 18

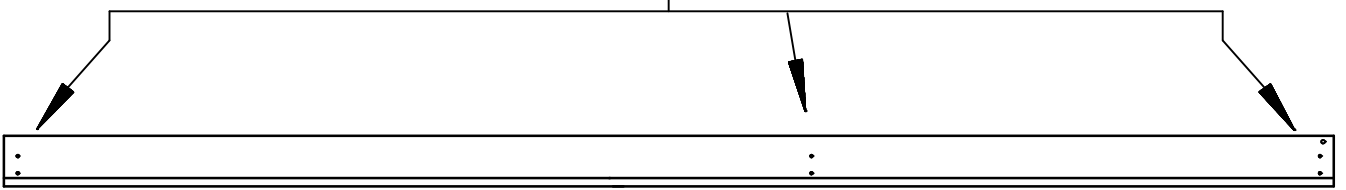

11.

631.1472.000  
3,5 x 15 mm

641.0380.000

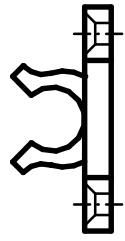

5

18

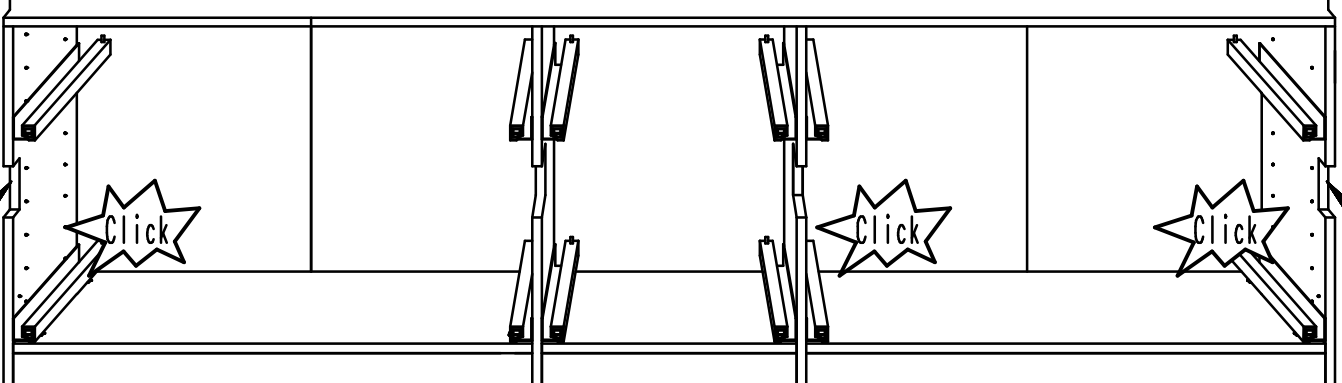
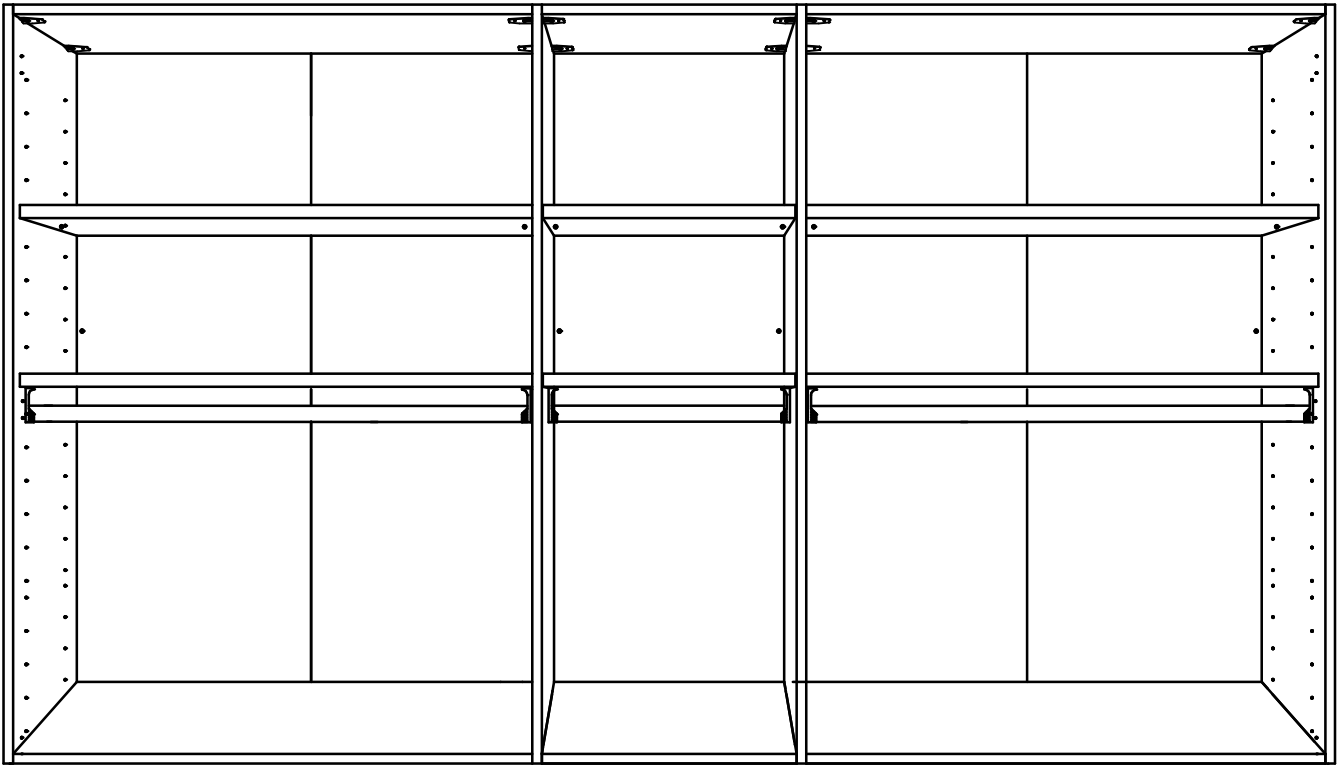

5 18

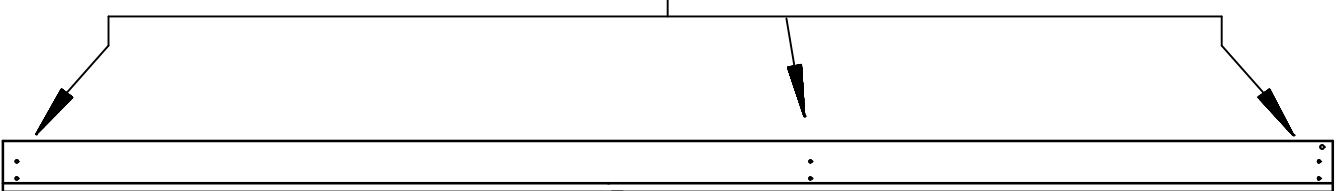

12.

623.0054.000



19

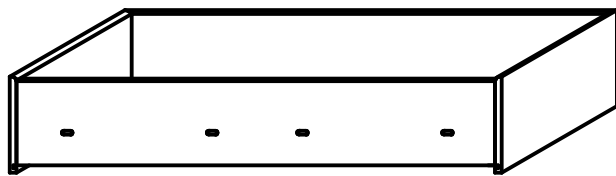
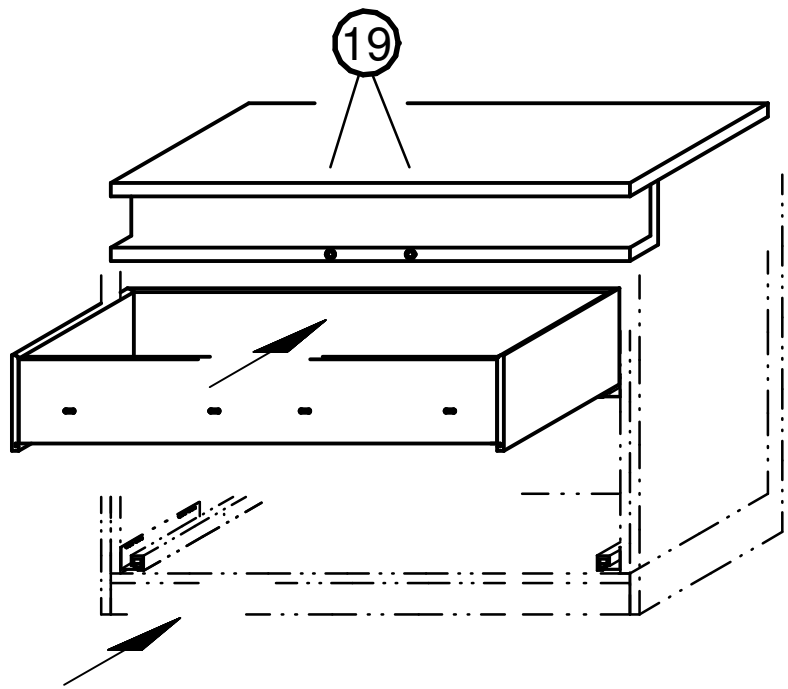

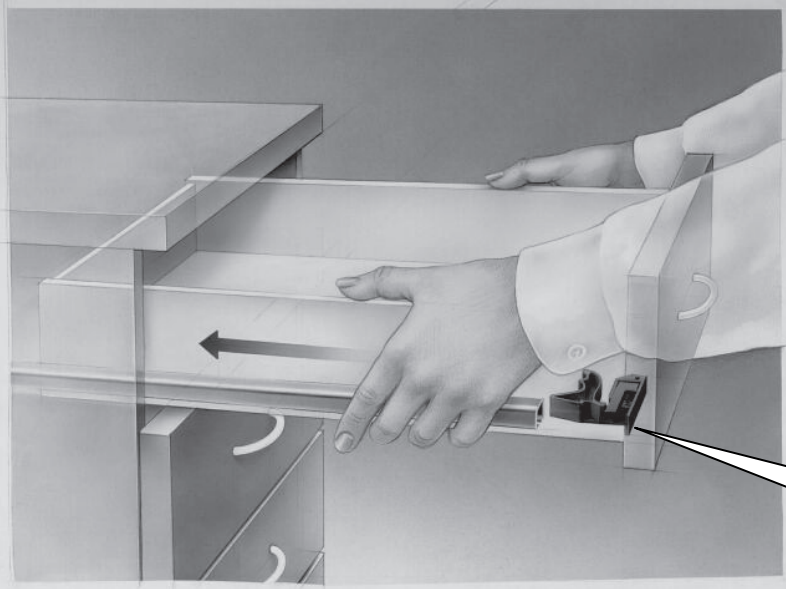

**click**

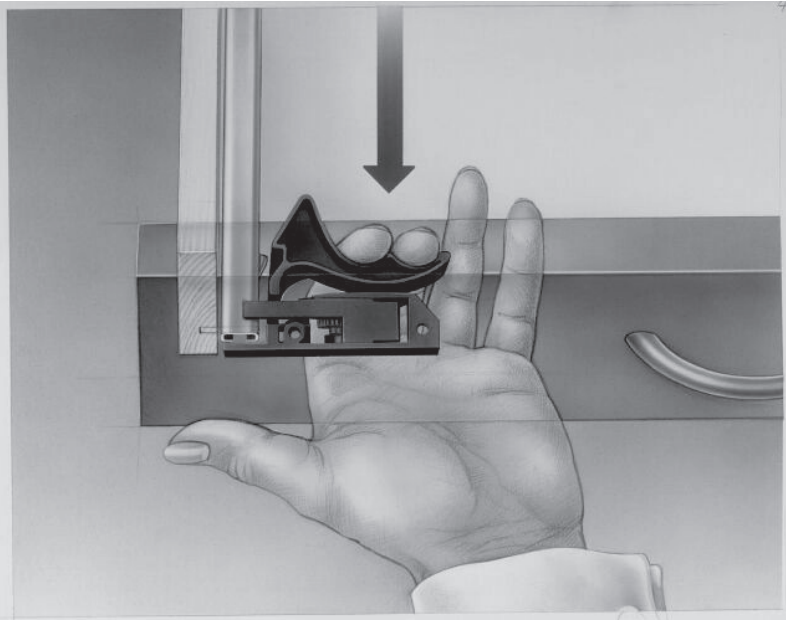
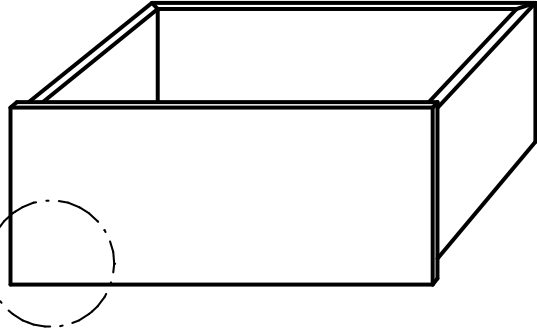
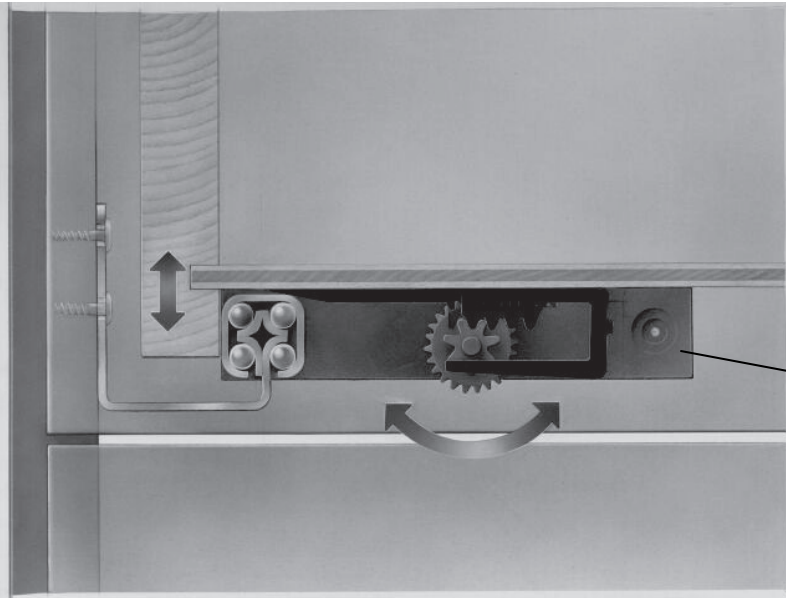

13.

632.0500.000  
M6 x 25 mm

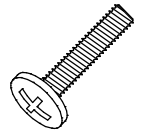

20

20

20

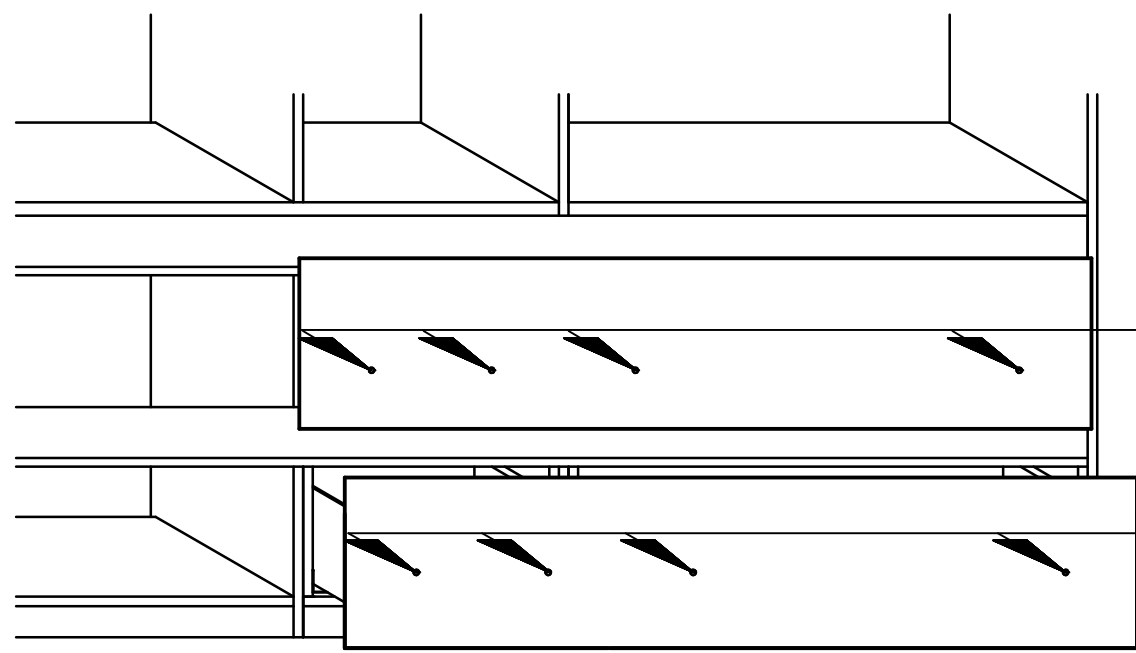
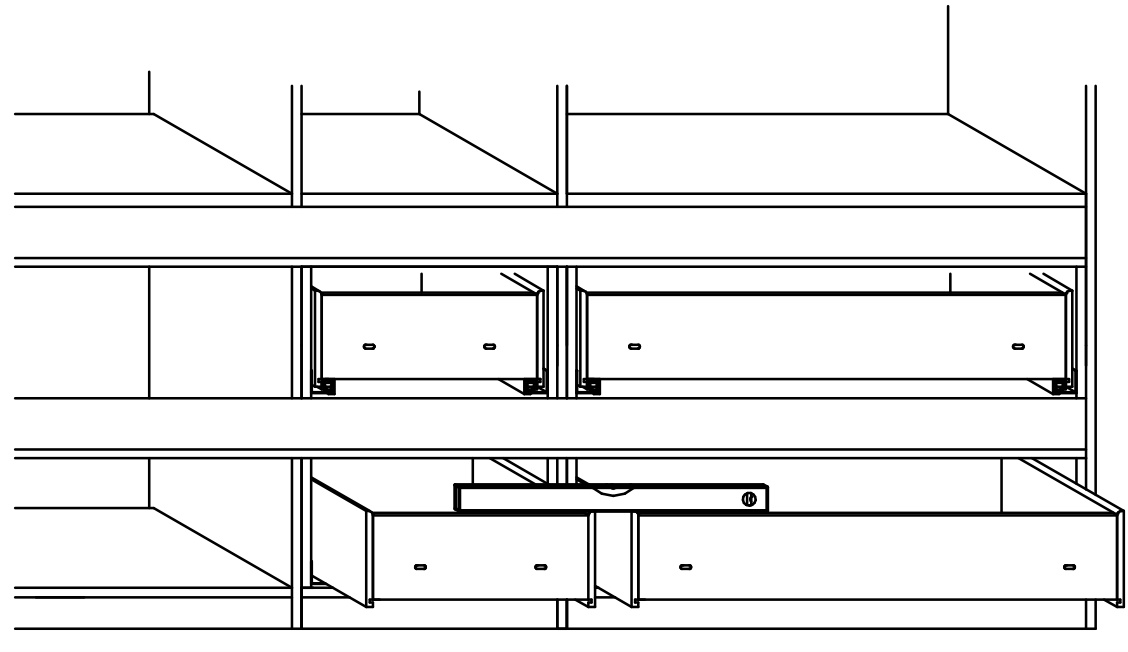
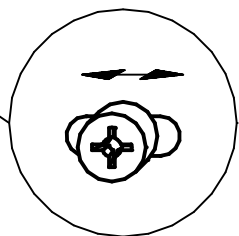

20

20

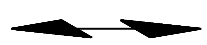



14.

641.1339.000



21

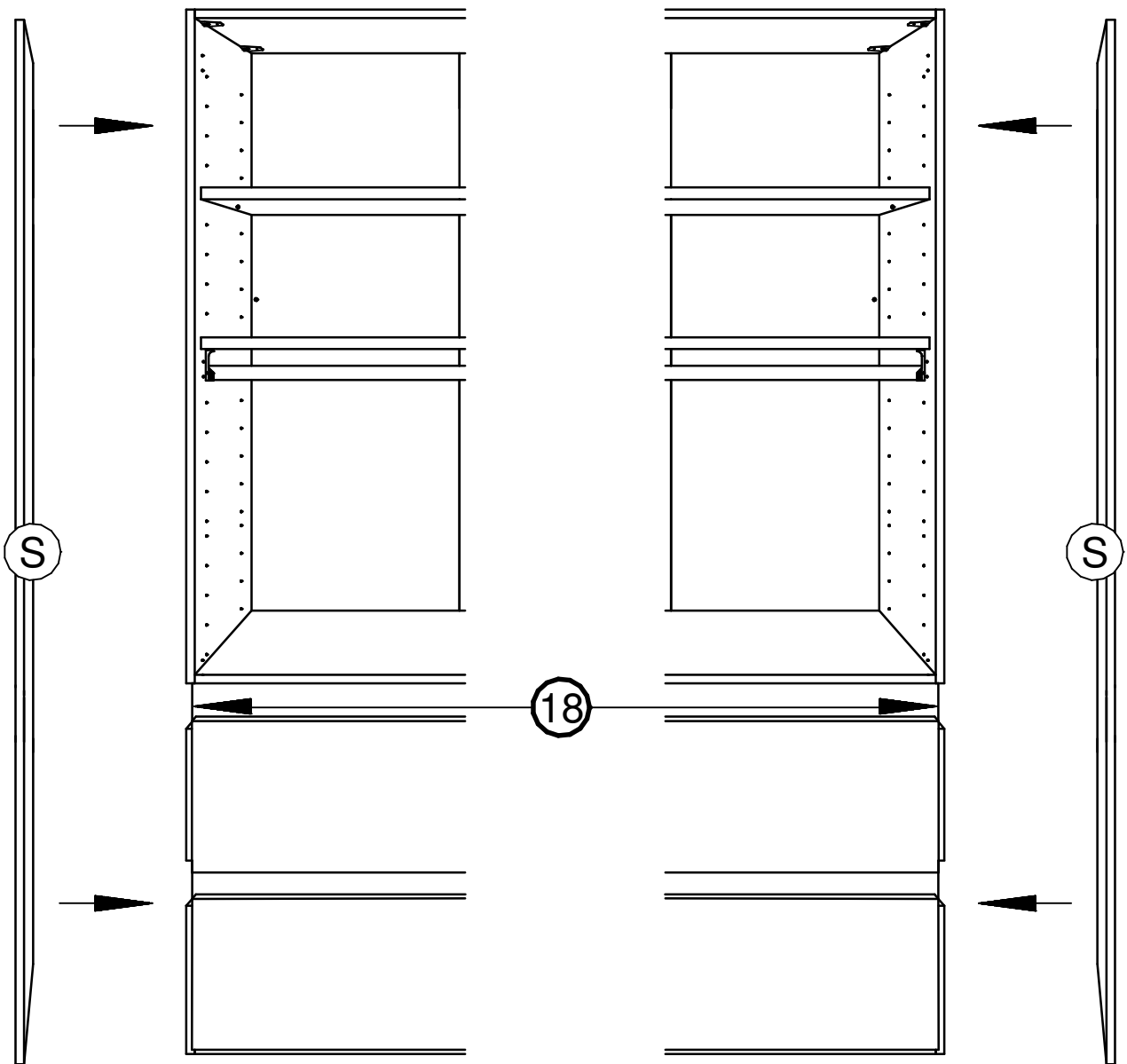

15.

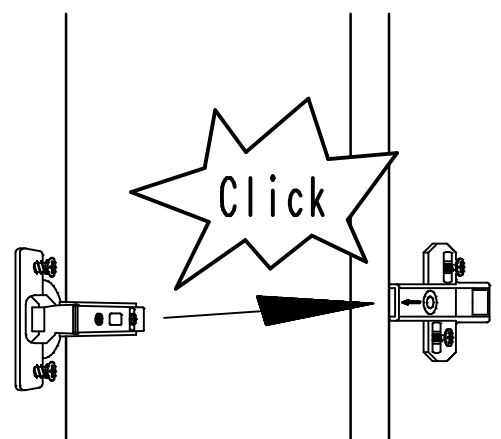
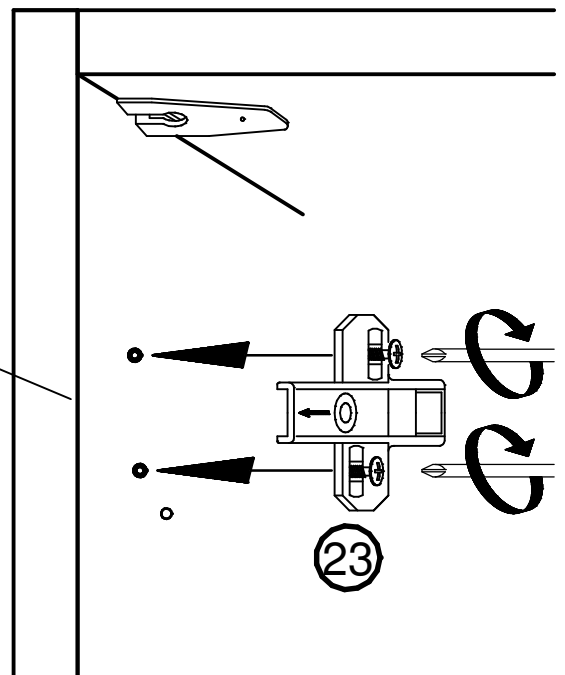
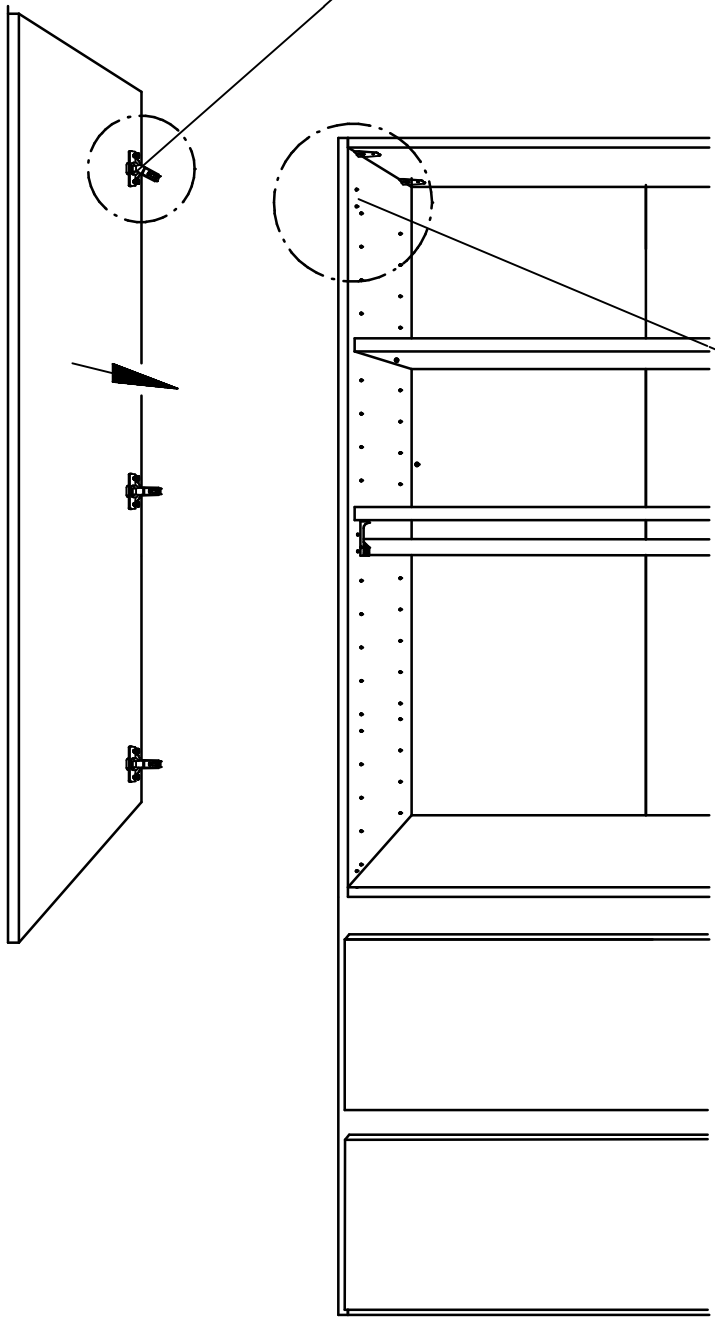
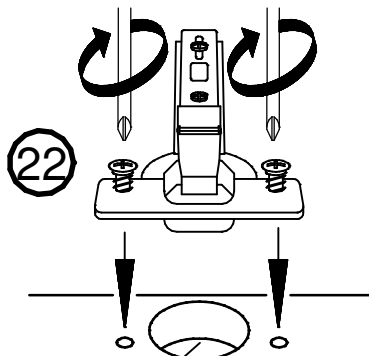
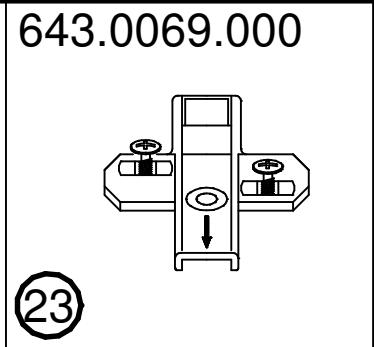
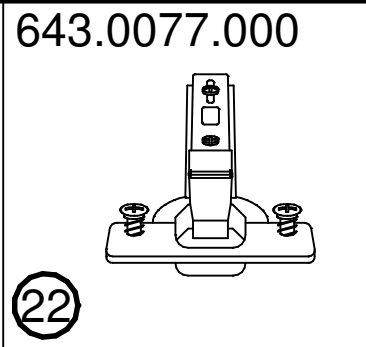

16.

