

20.03.1312.00

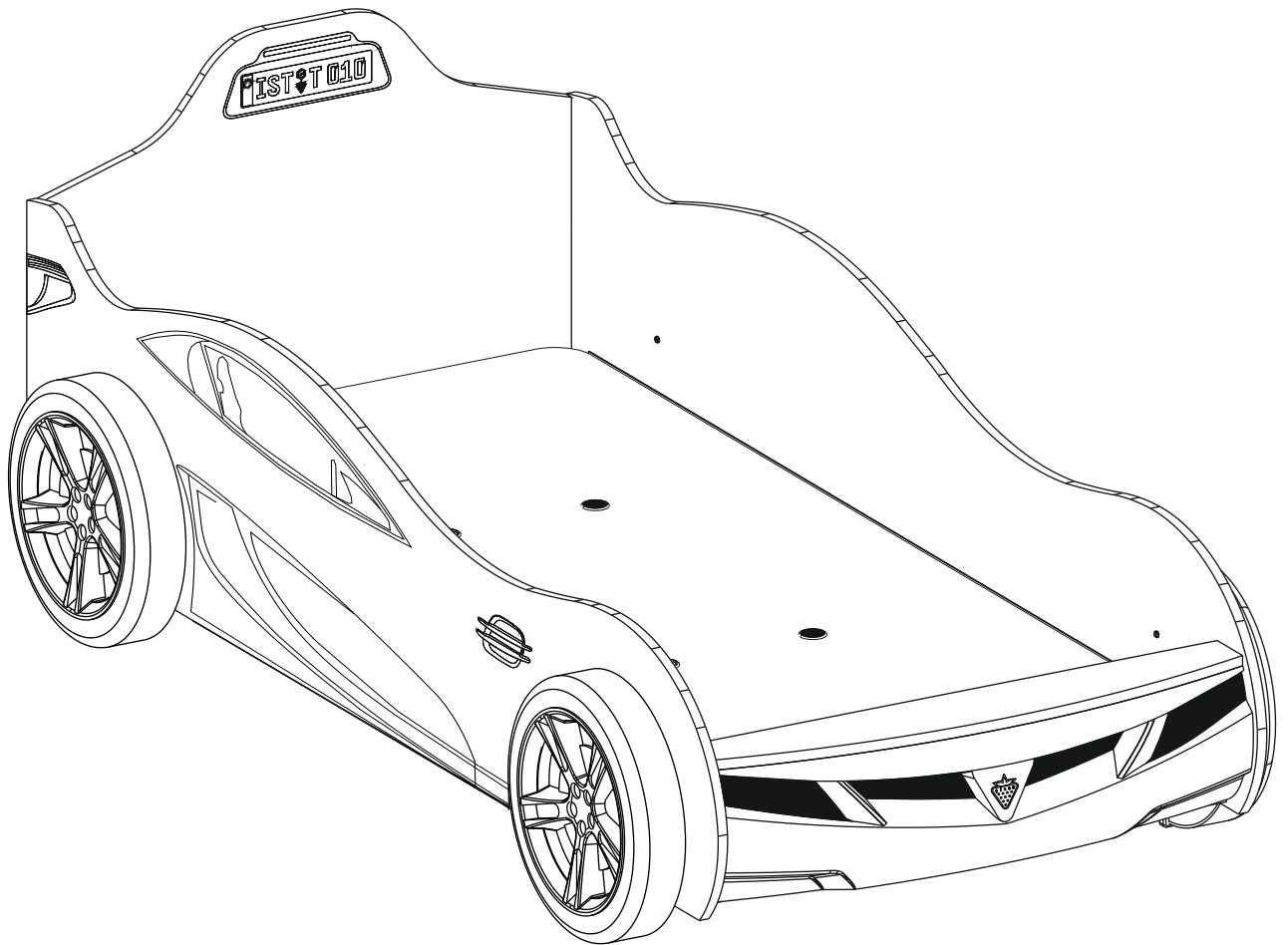

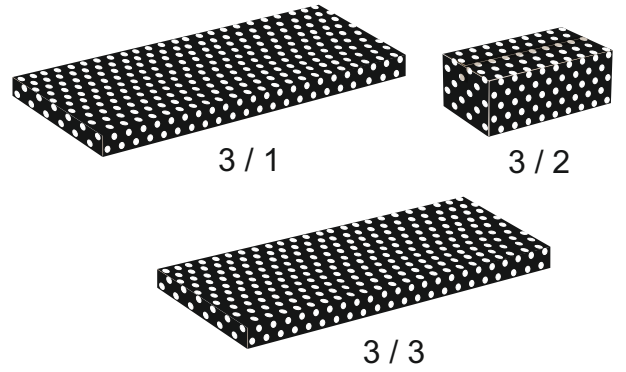
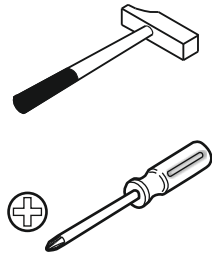
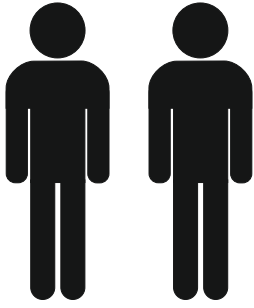

3/1

3/2

3/3

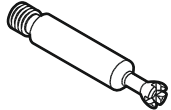

13.07.01.108 x 10



13.07.01.110 x 10

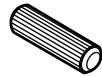

13.01.01.111 x 10



13.02.01.017 x 30



13.01.01.058 x 10

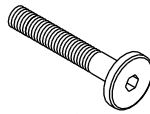

13.03.01.029 x 8

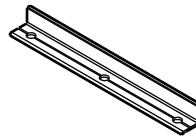

18.03.1312.202 x 2



13.07.01.016 x 1

3/1

18.03.1312.002 x 1

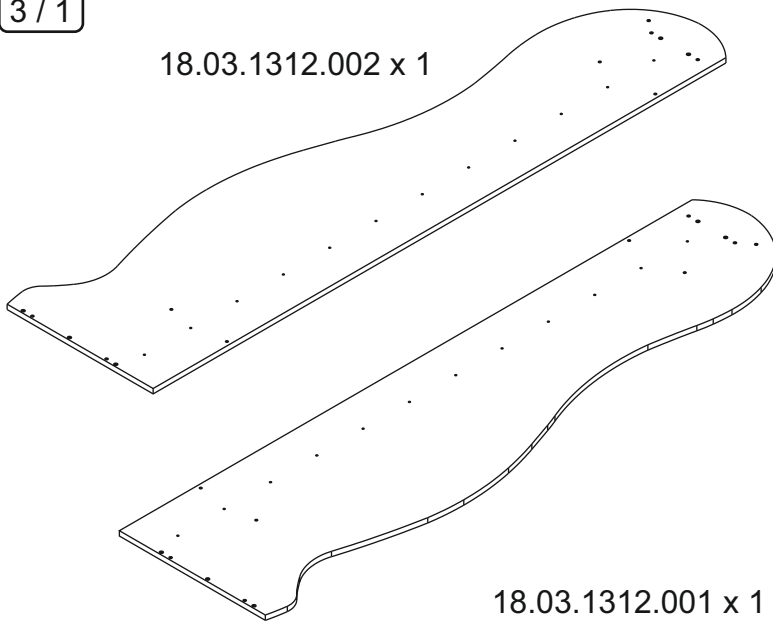

18.03.1312.001 x 1

3/2

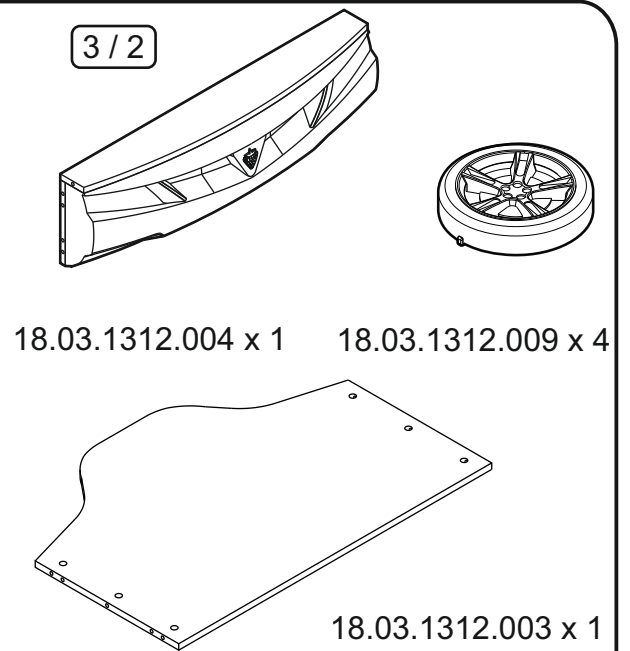

18.03.1312.004 x 1

18.03.1312.009 x 4

18.03.1312.003 x 1

3/3

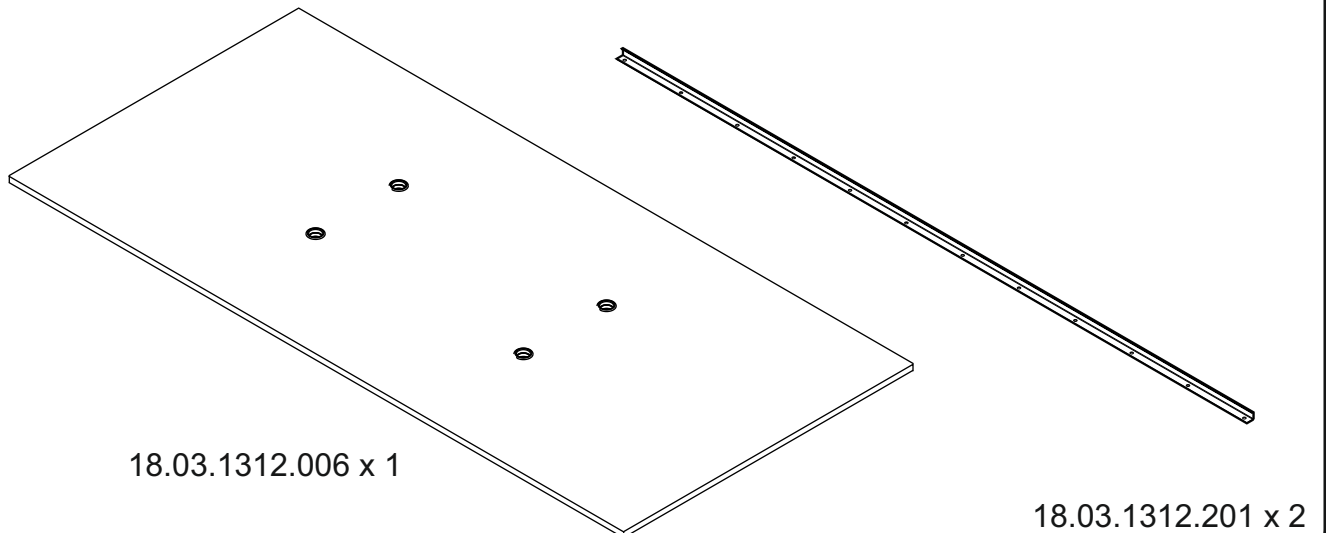

18.03.1312.006 x 1

18.03.1312.201 x 2

1

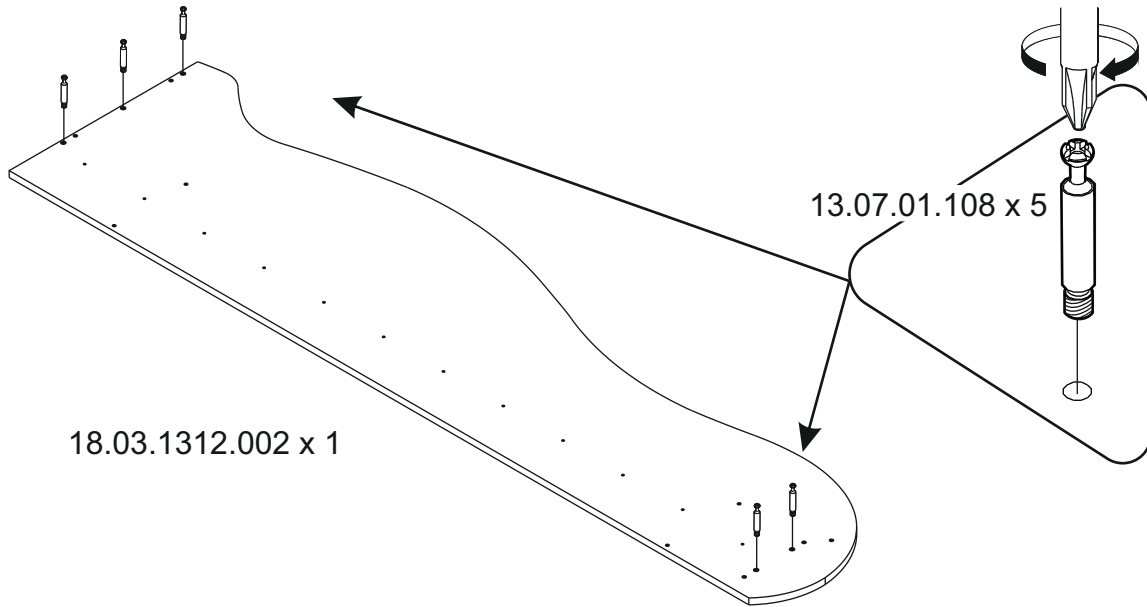

2

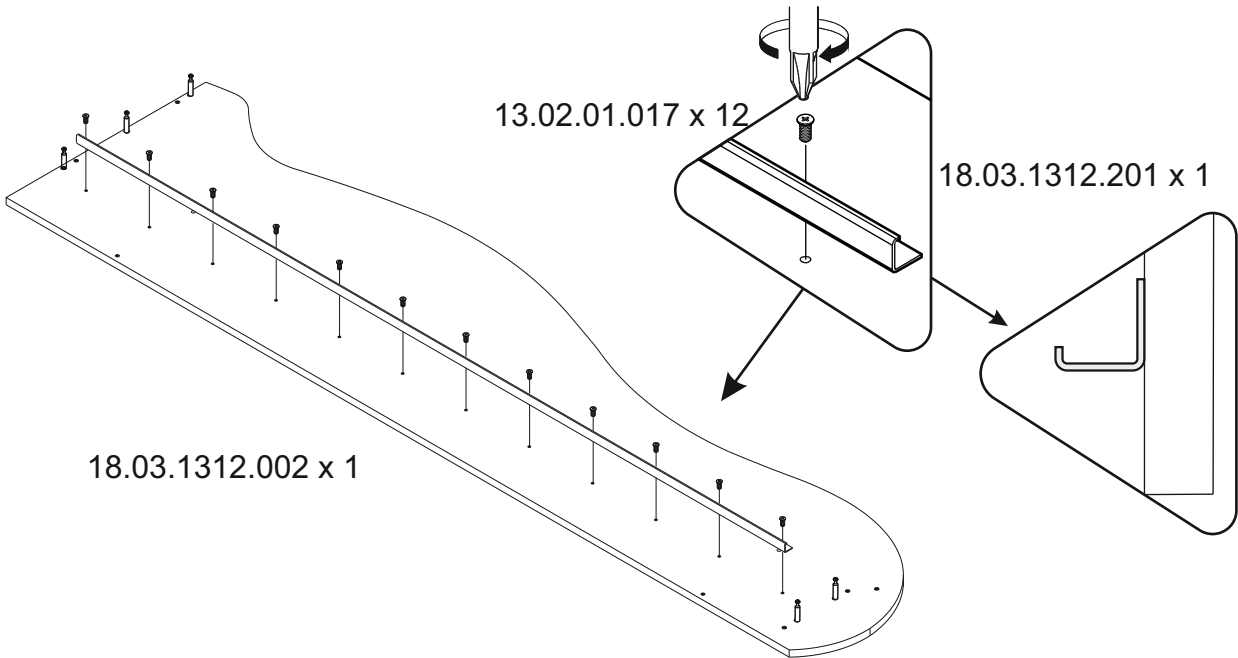

3

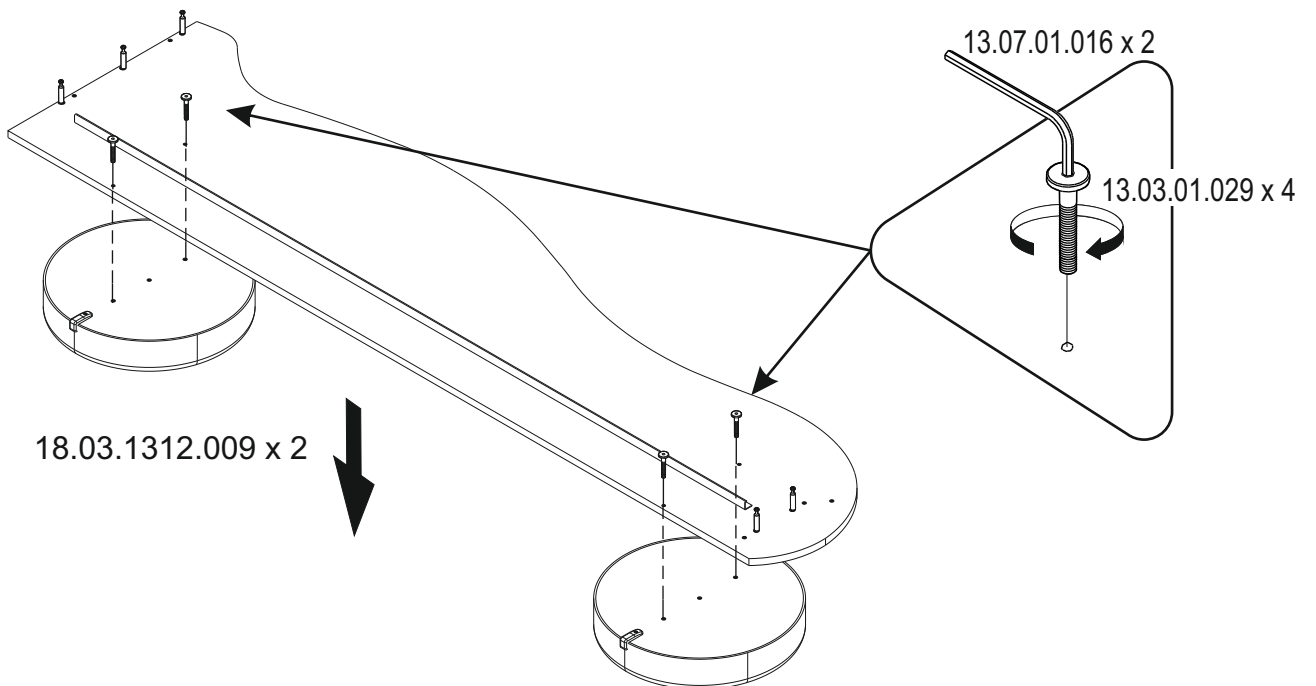

4

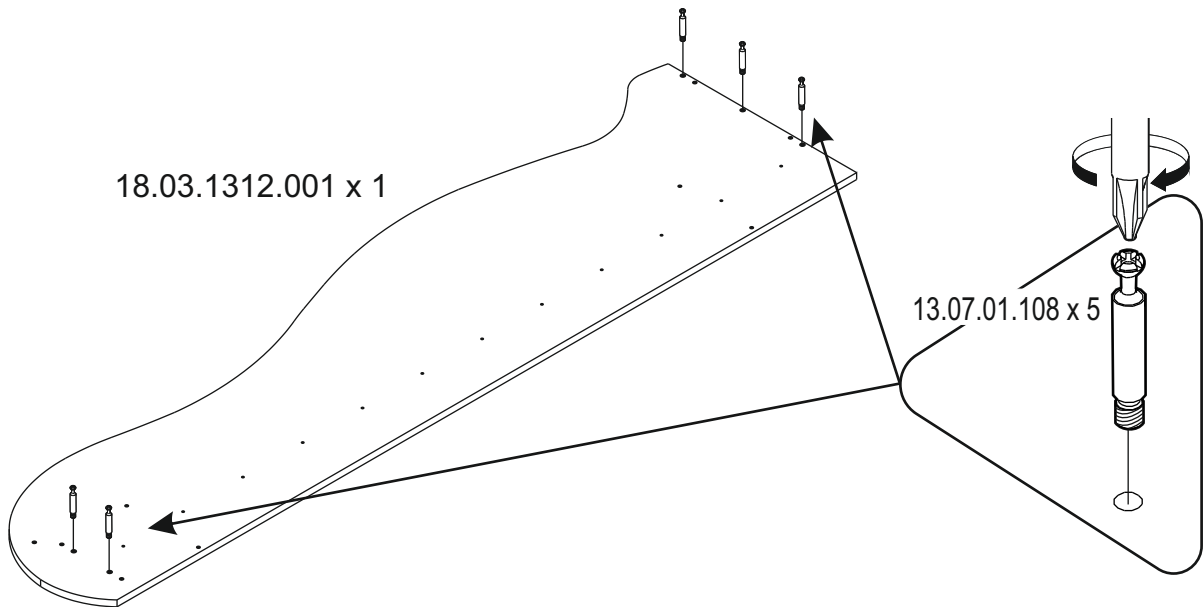

5

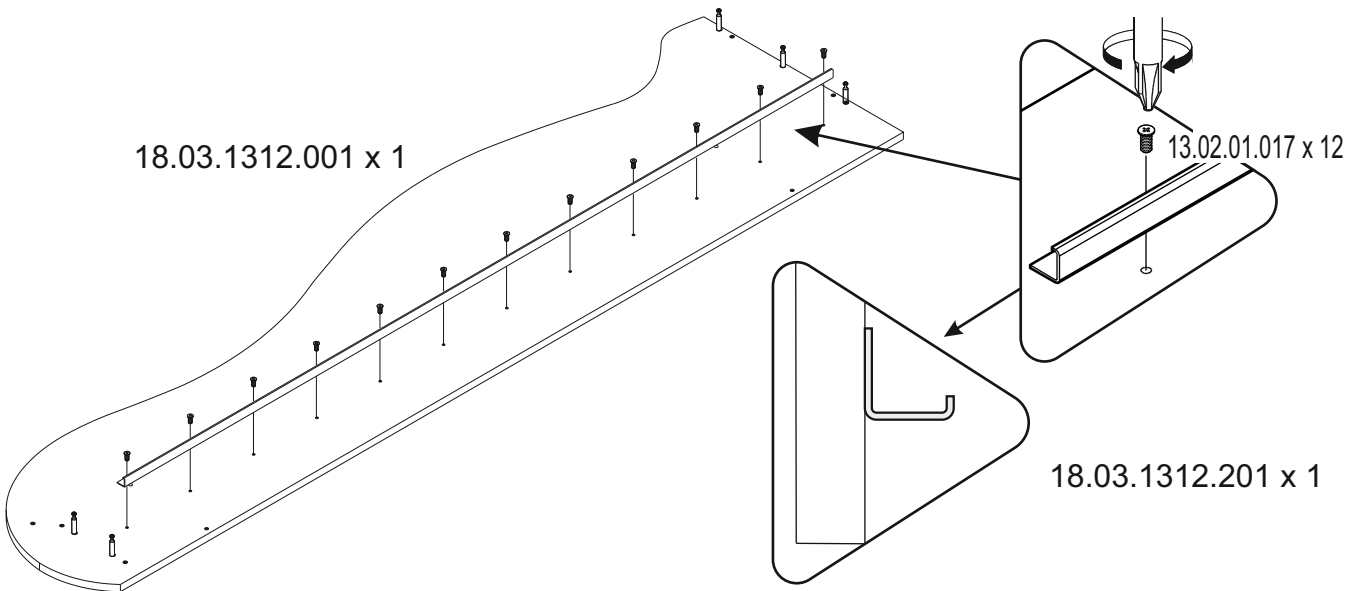

6

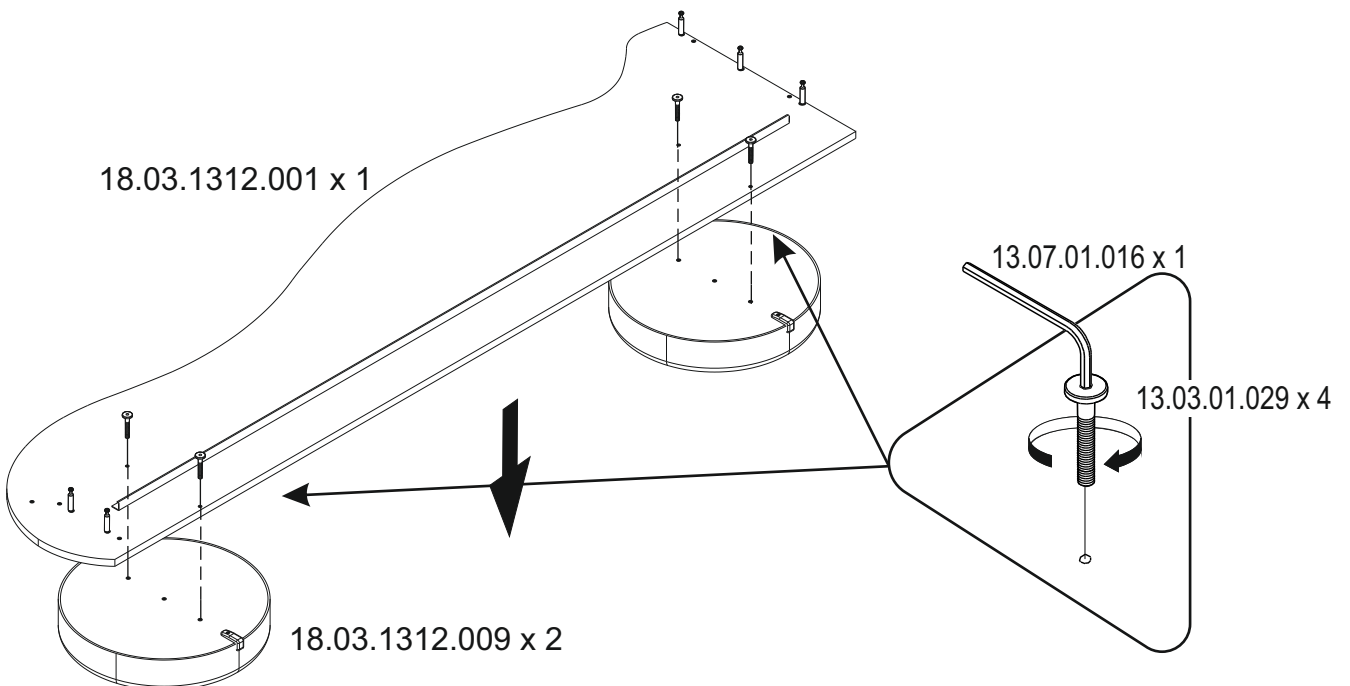

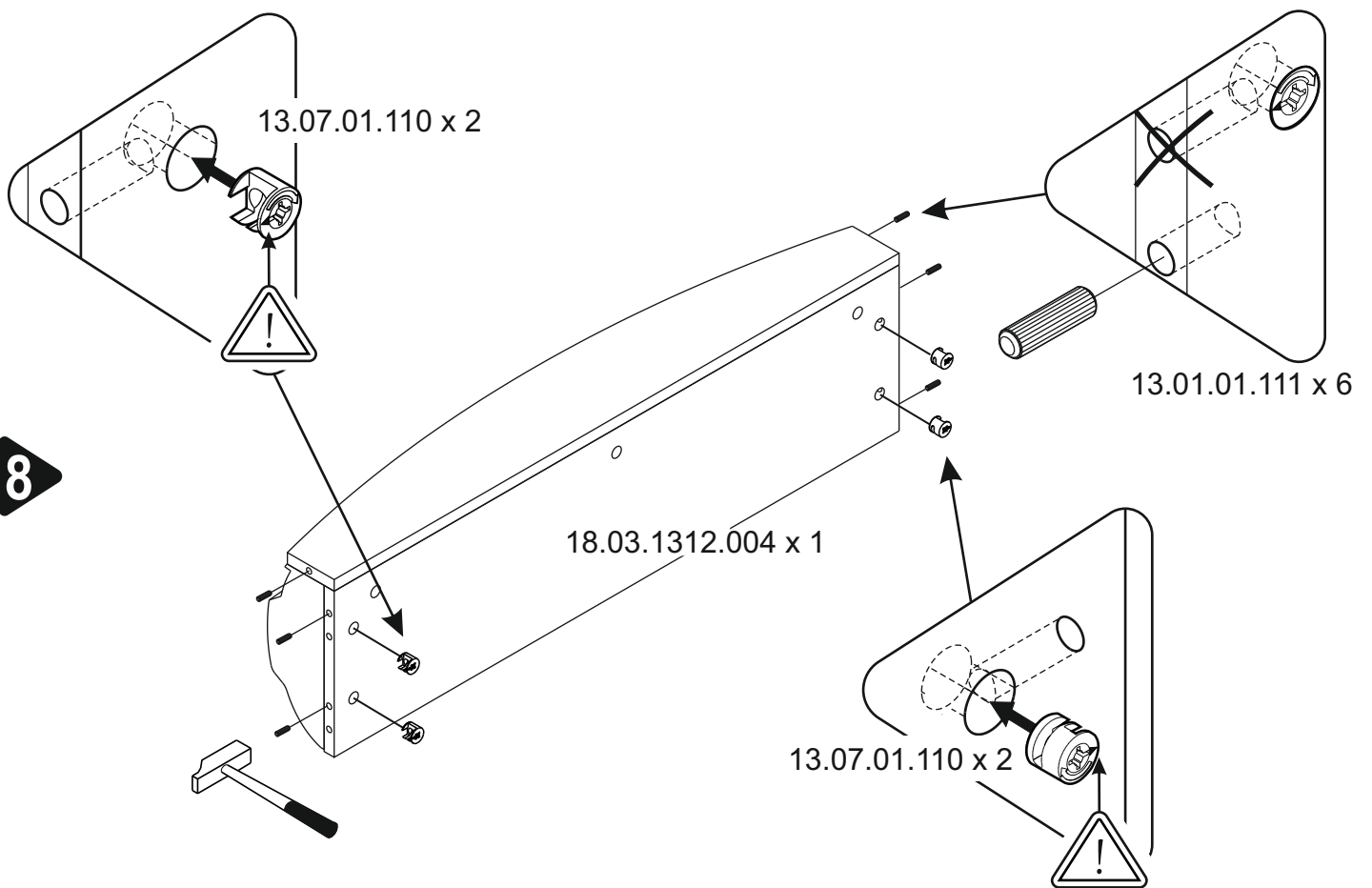
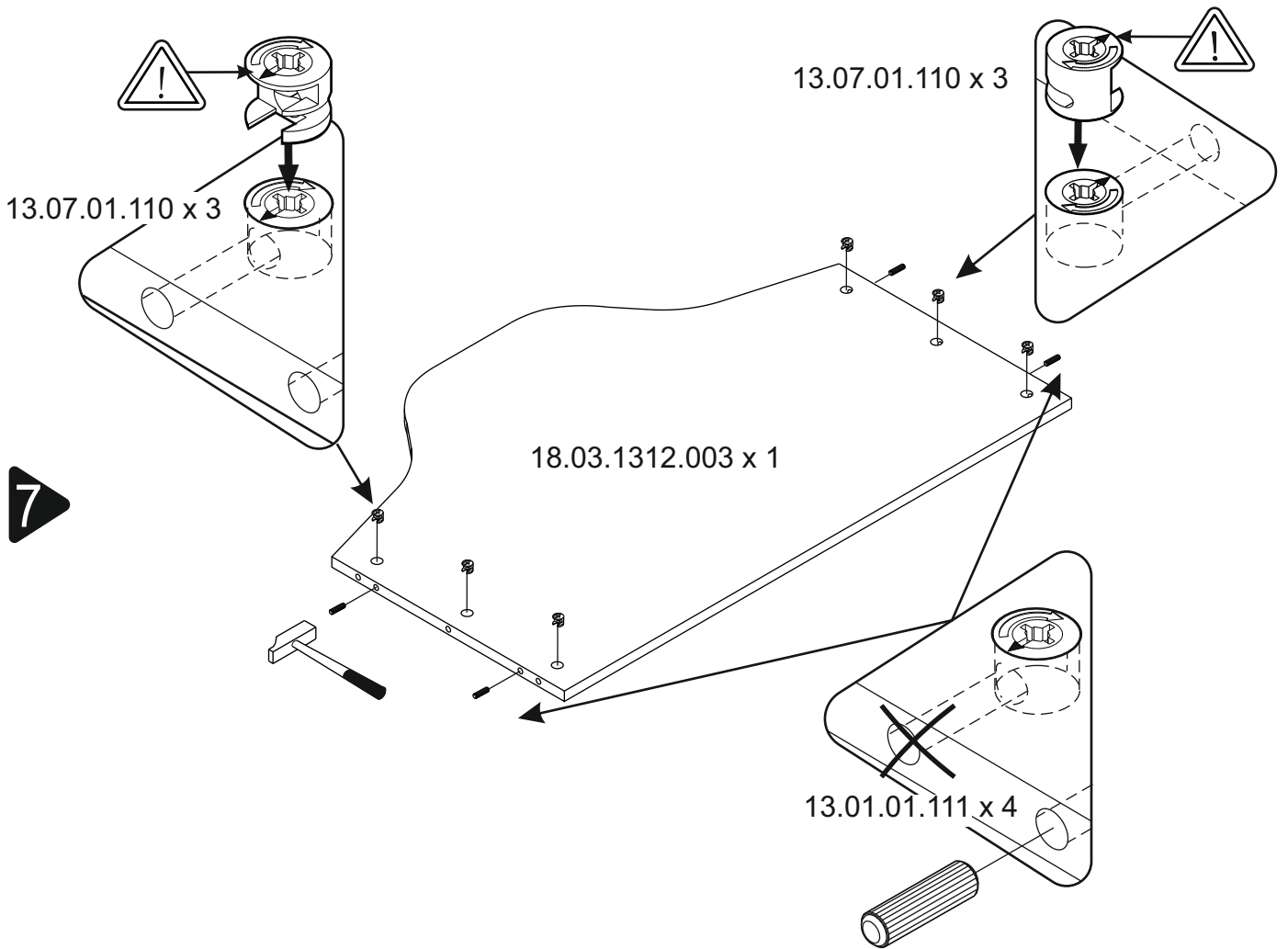

9

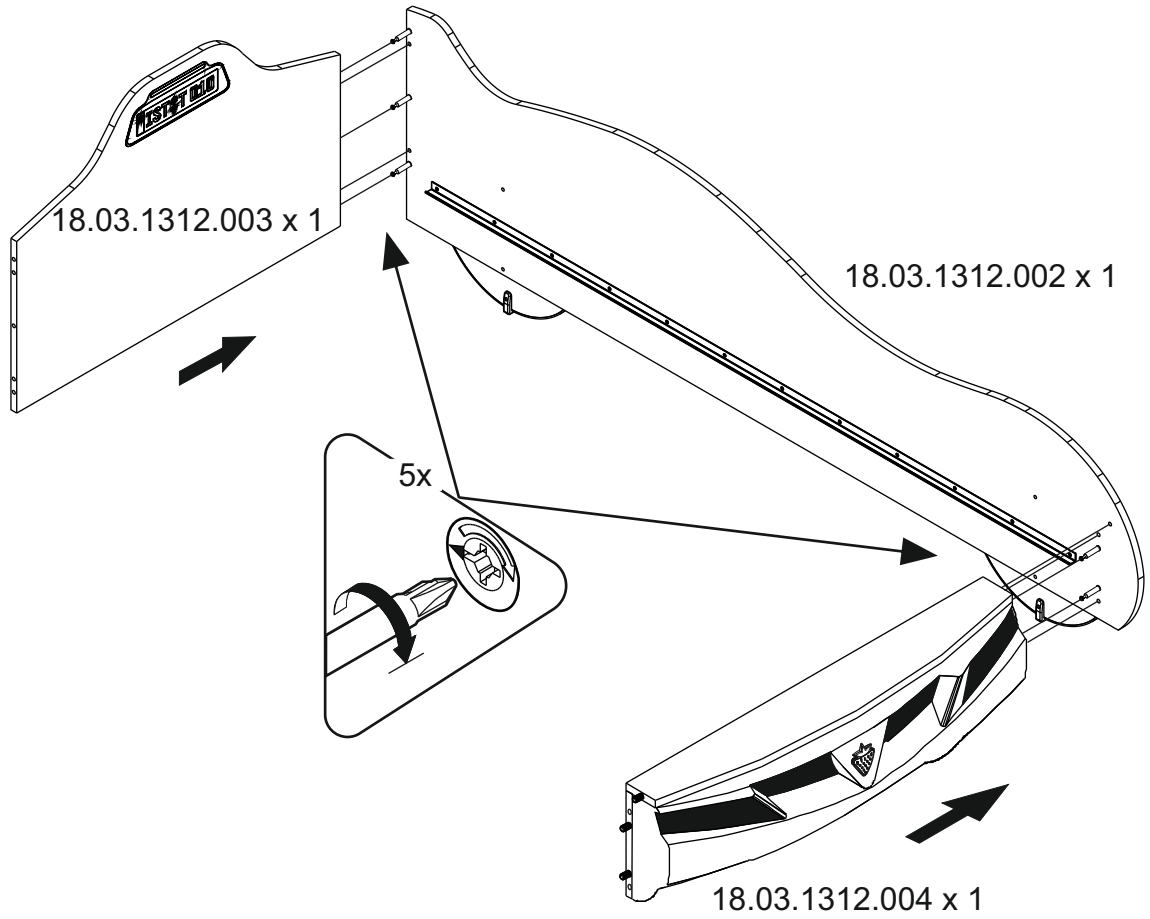

10

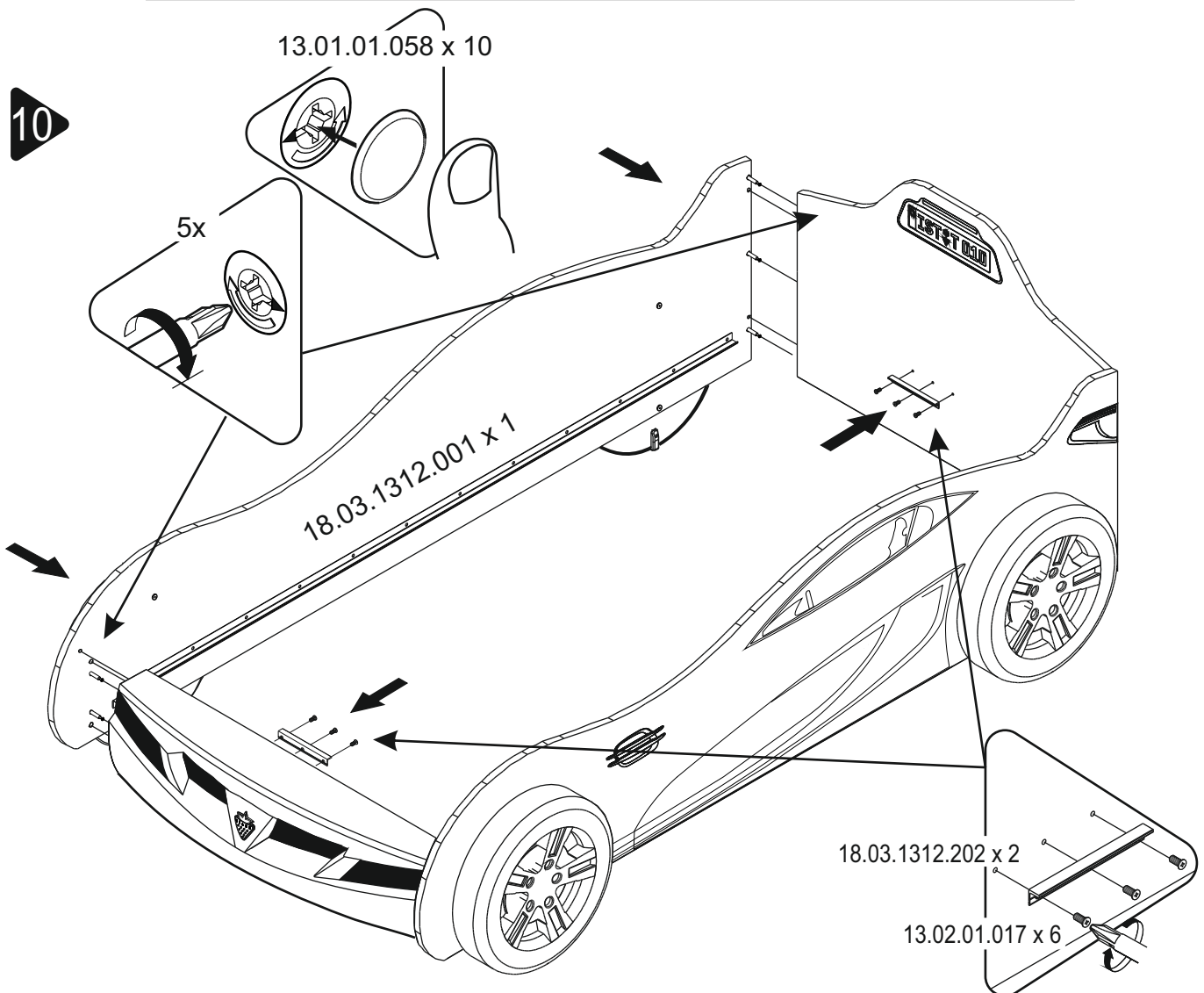

11

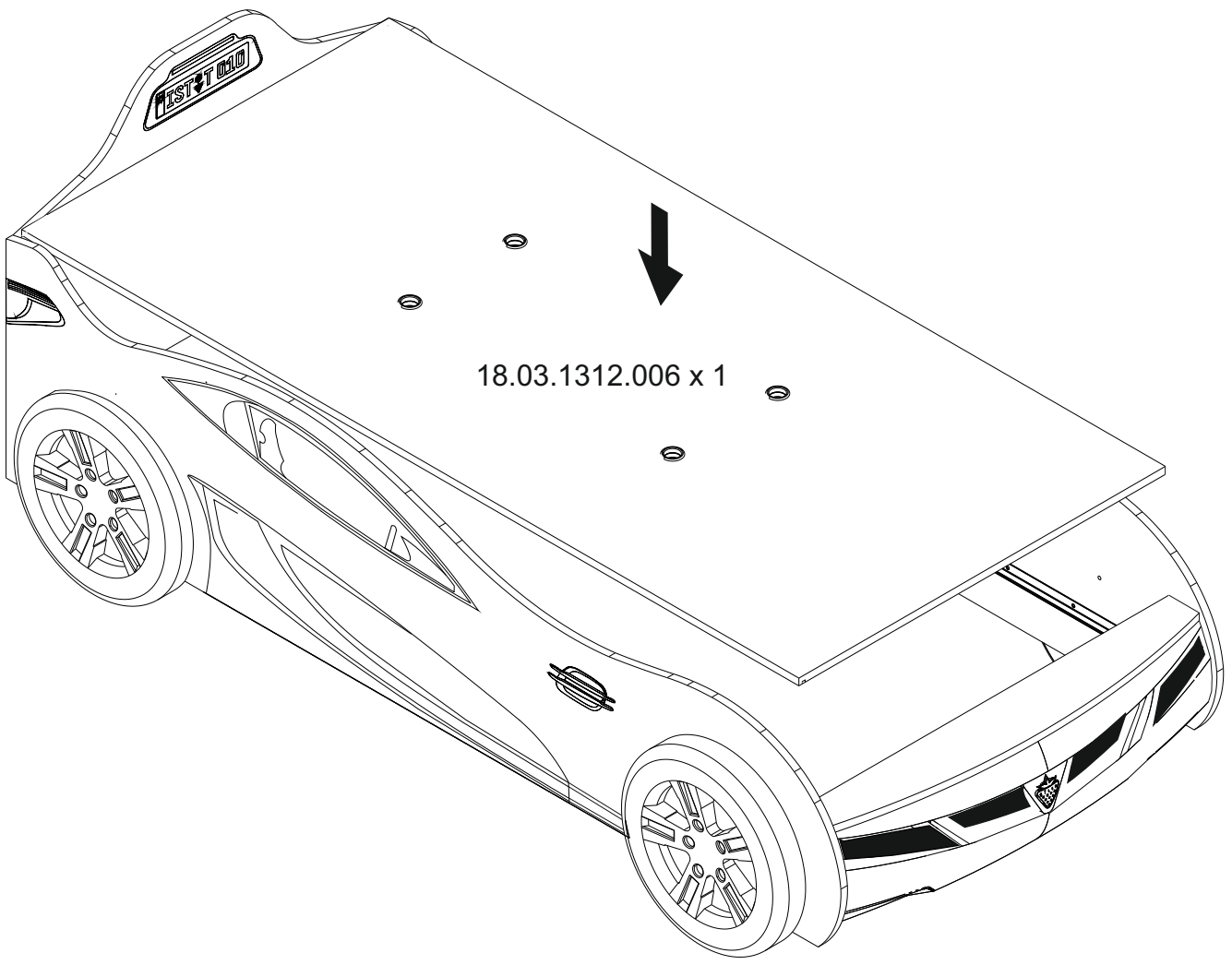

18.03.1312.006 x 1