

20.76.1702.00

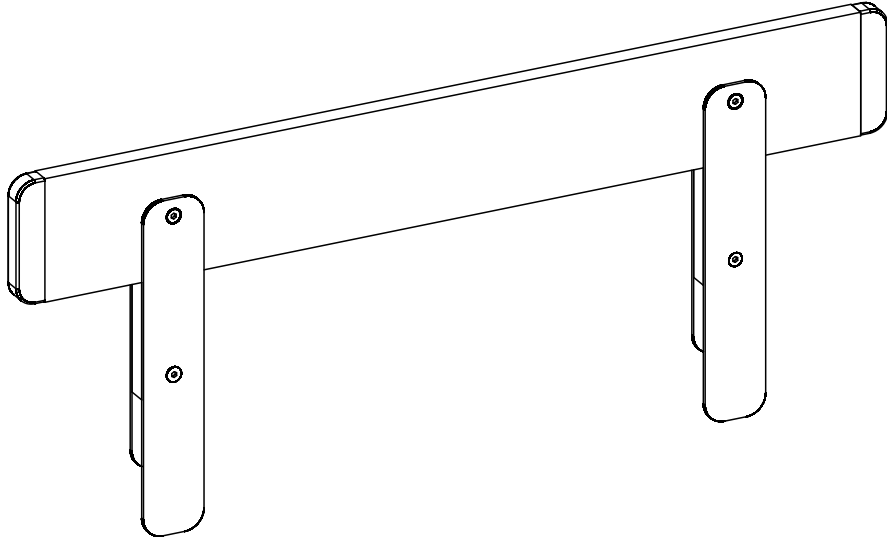

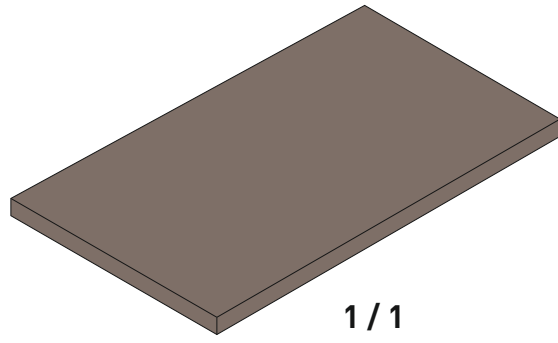
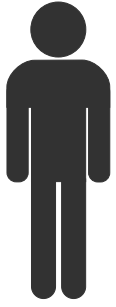

1 / 1

1 / 1

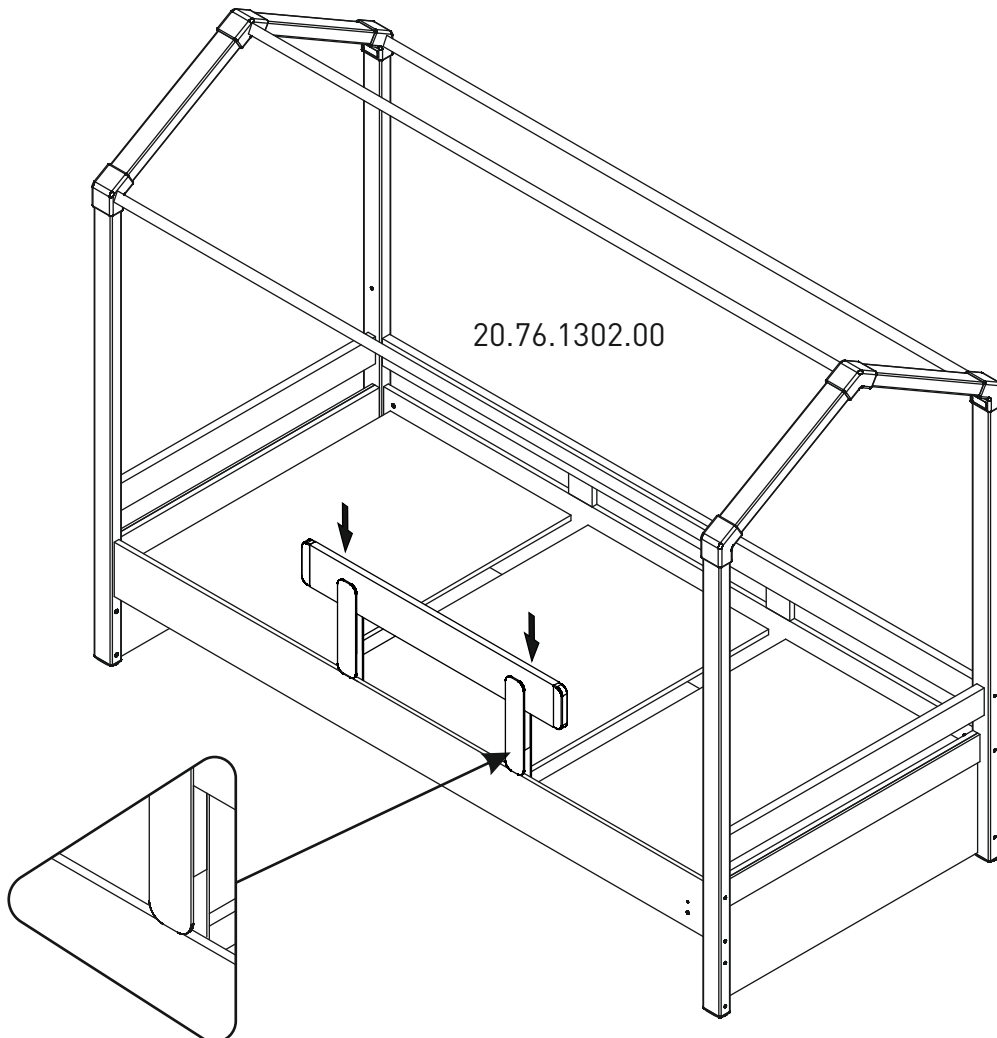
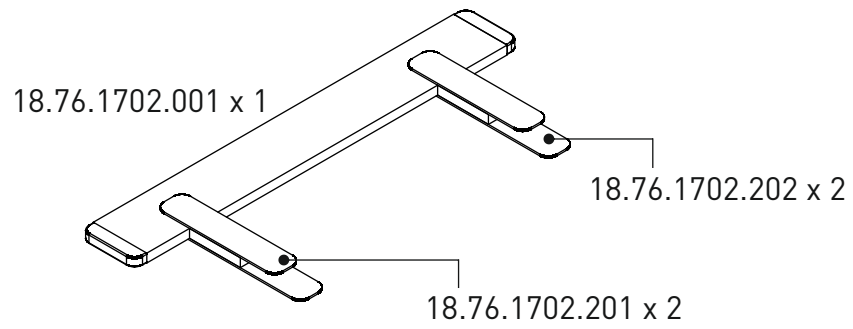

1