

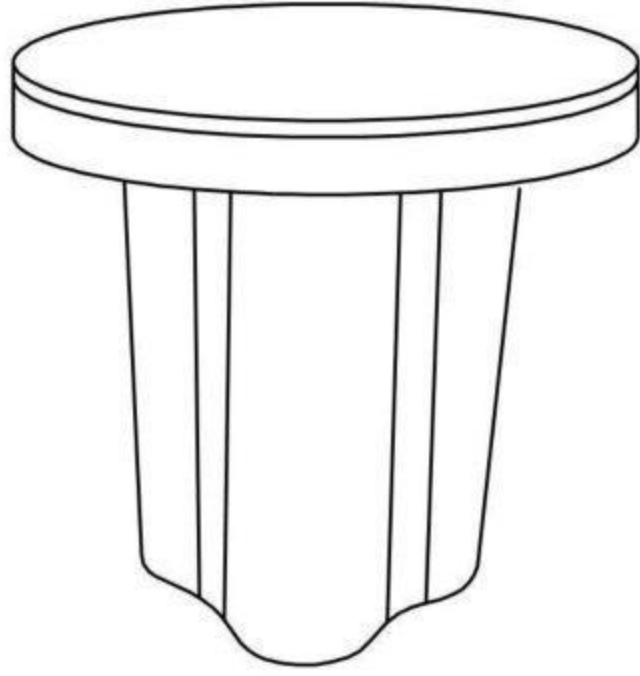





IMPORTANT – READ CAREFULLY – RETAIN FOR FUTURE REFERENCE
WICHTIG – SORGFÄLTIG LESEN UND AUFBEWAHREN

MAGNUM S

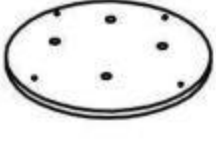
 max. 20 kg



A 1 	B 1 	C 1 
D 8  8*25MM	E 8  8MM	F 1  M5

1

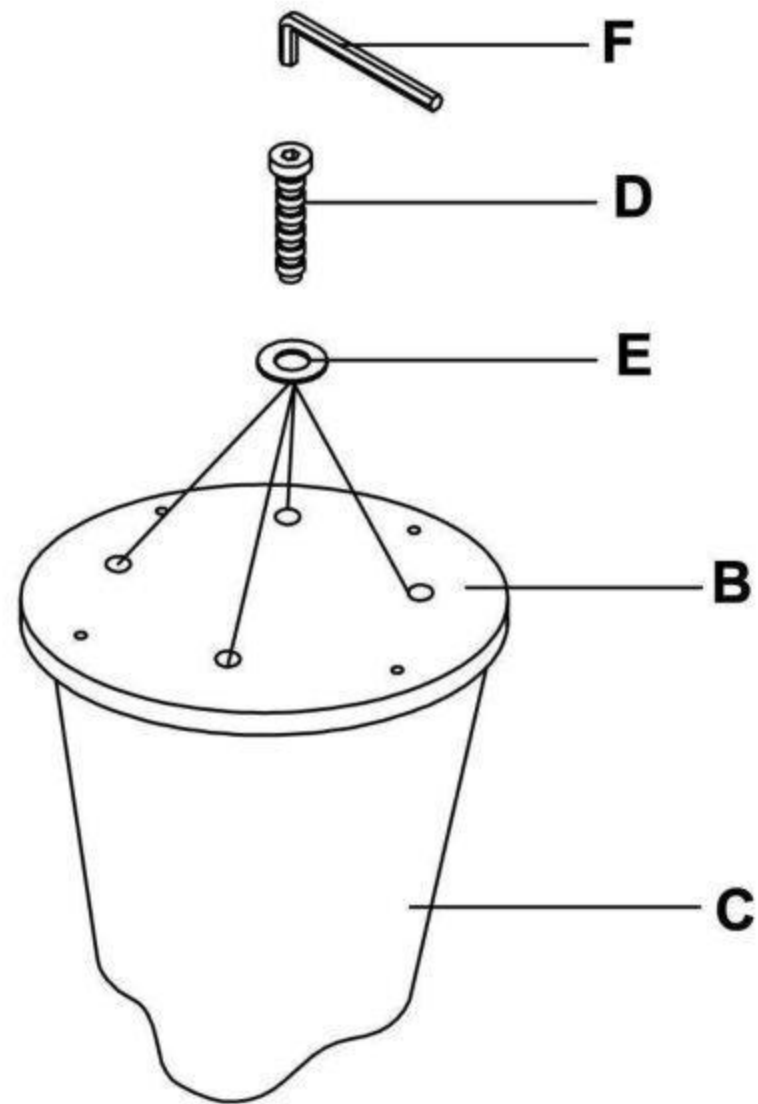

2

