

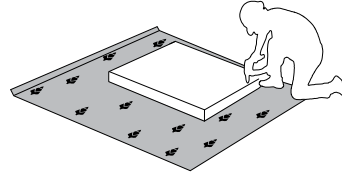

IMPORTANT - READ CAREFULLY - RETAIN FOR FUTURE REFERENCE
WICHTIG - SORGFÄLTIG LESEN UND AUFBEWAHREN

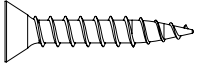

P3/TA
LHW - 1813x2271x584

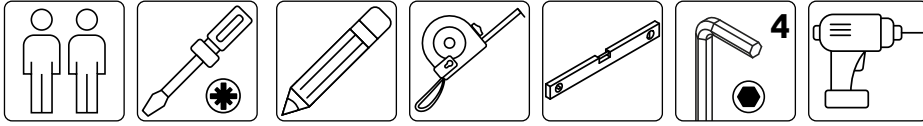
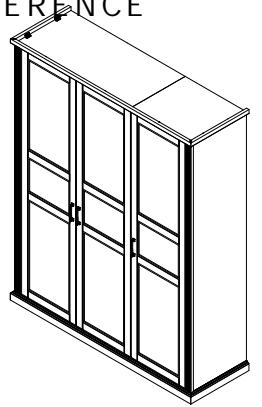
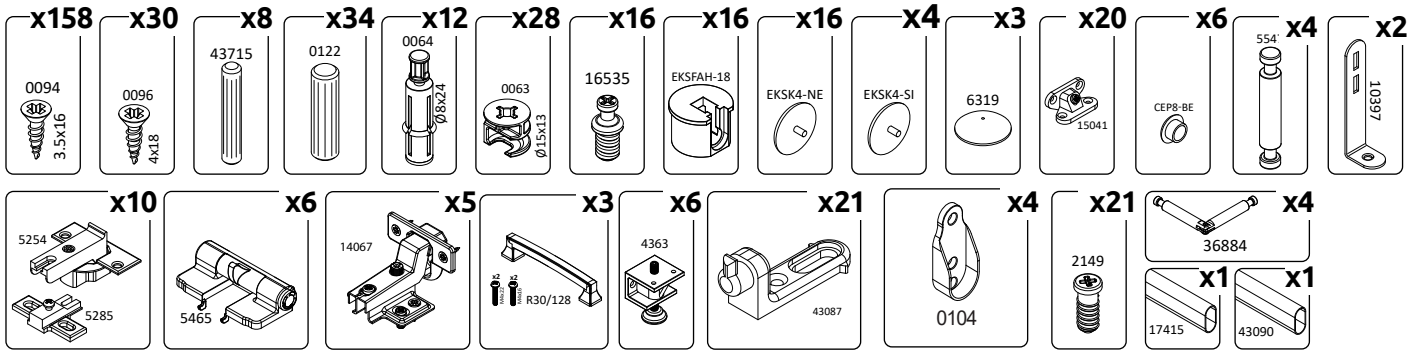

opt * -31
* -45

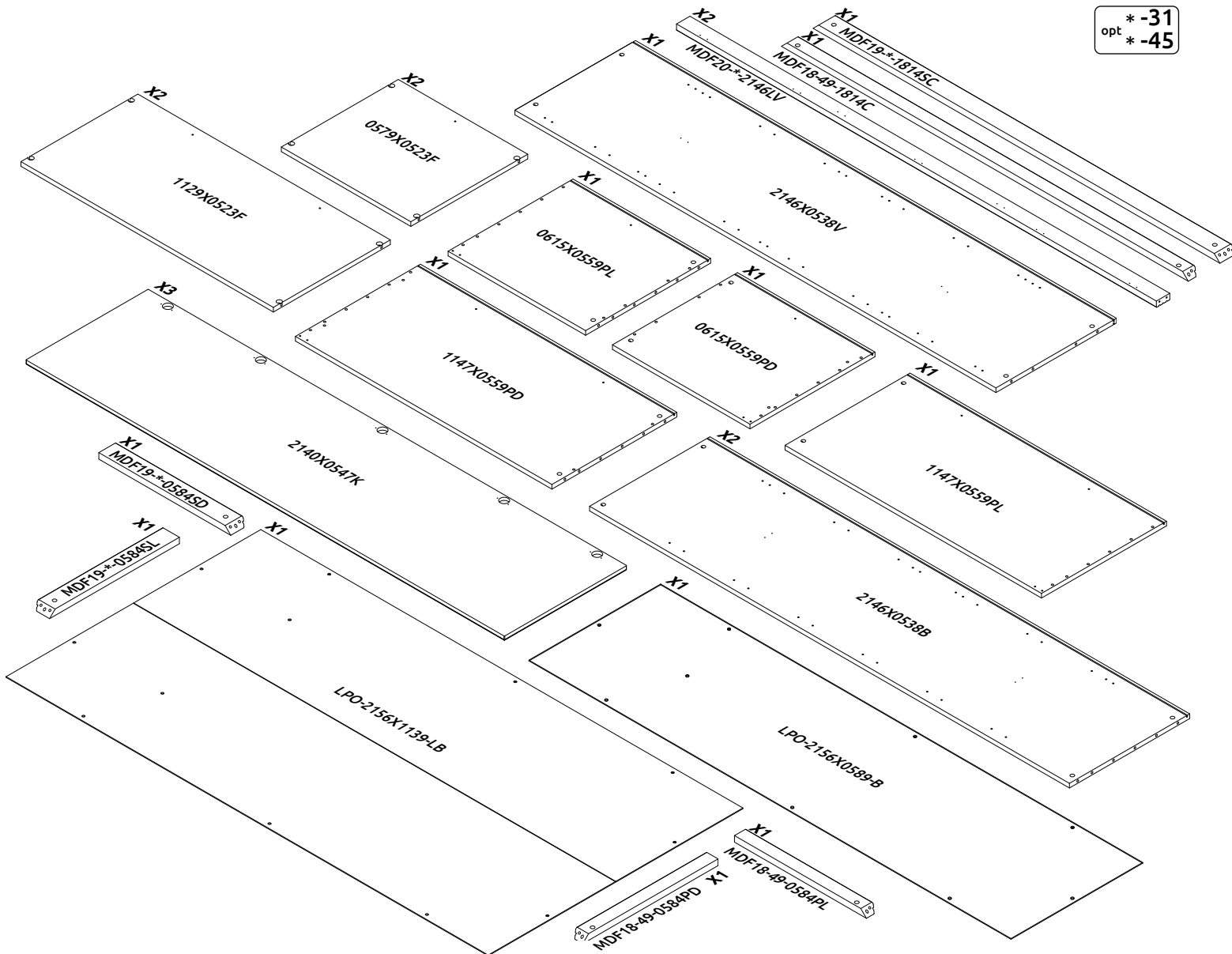

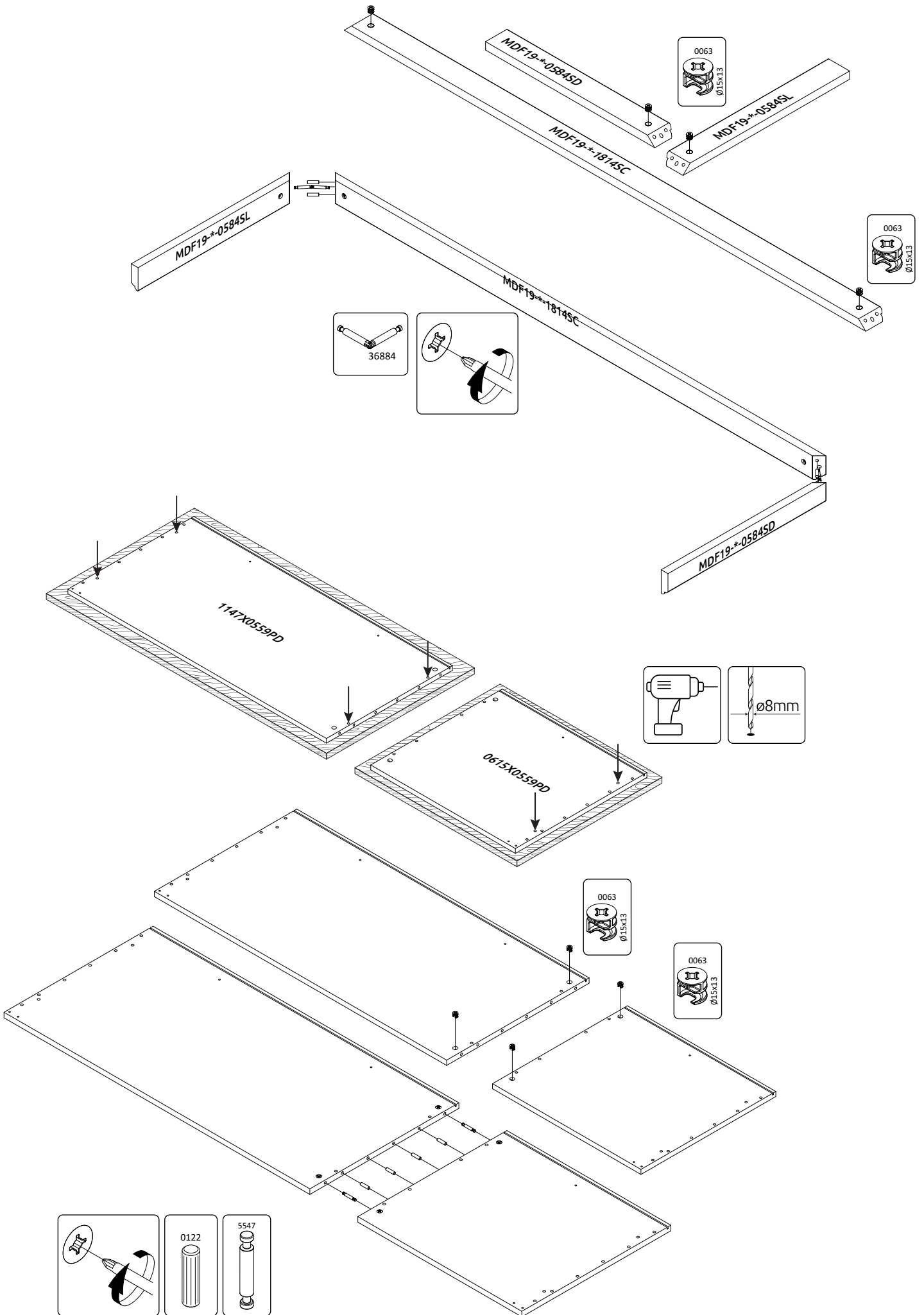

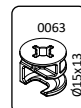
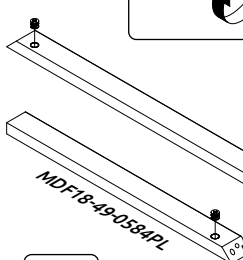
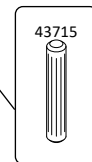
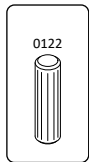
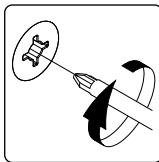
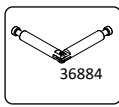
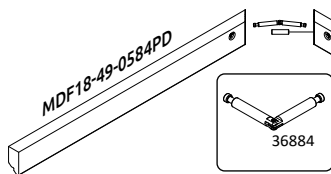
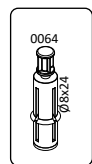
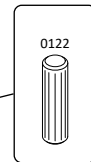
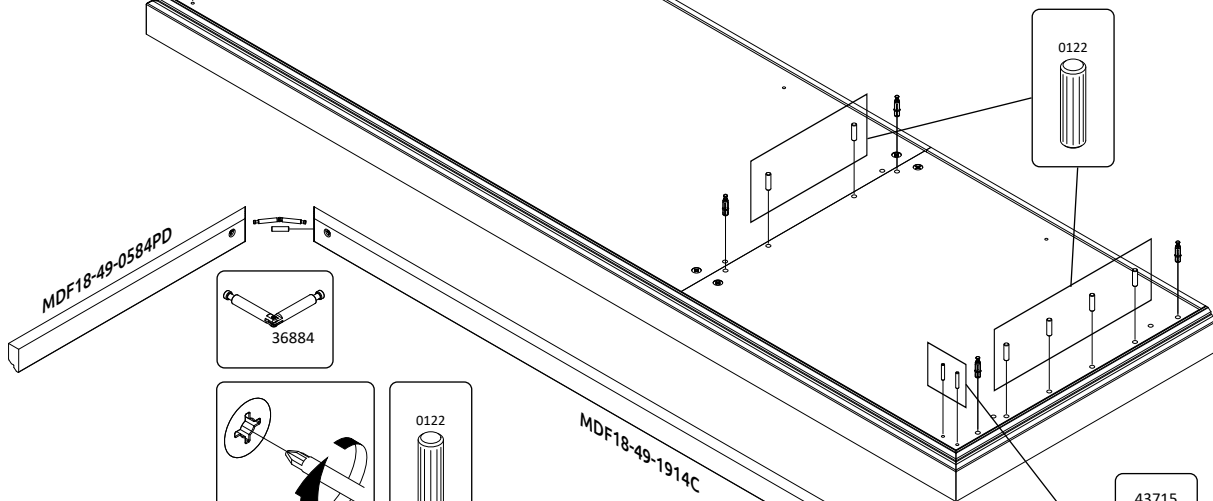
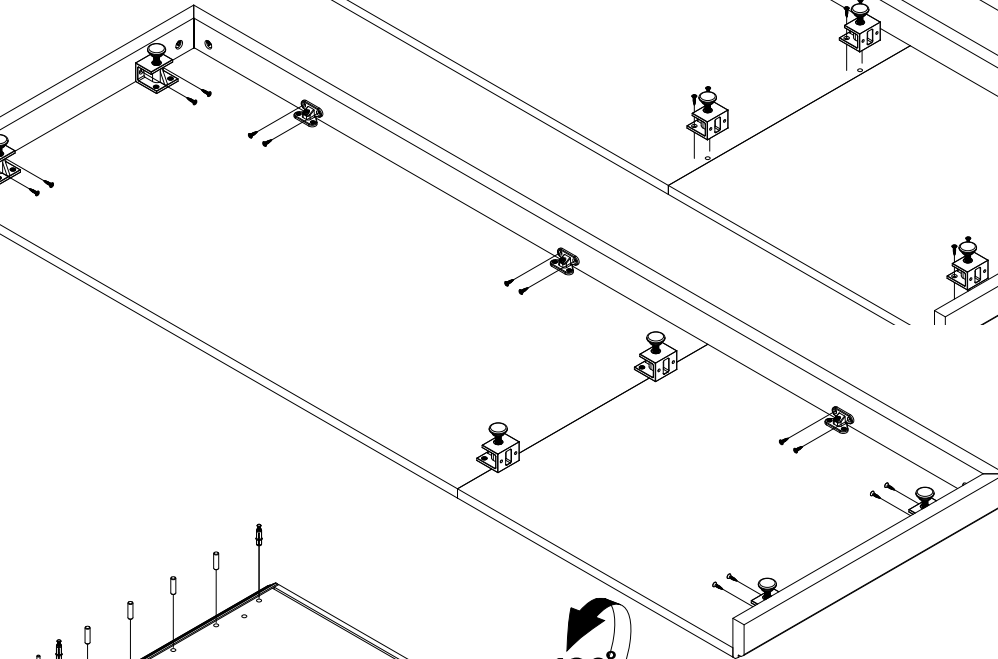
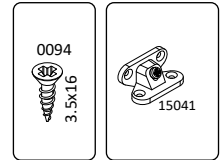
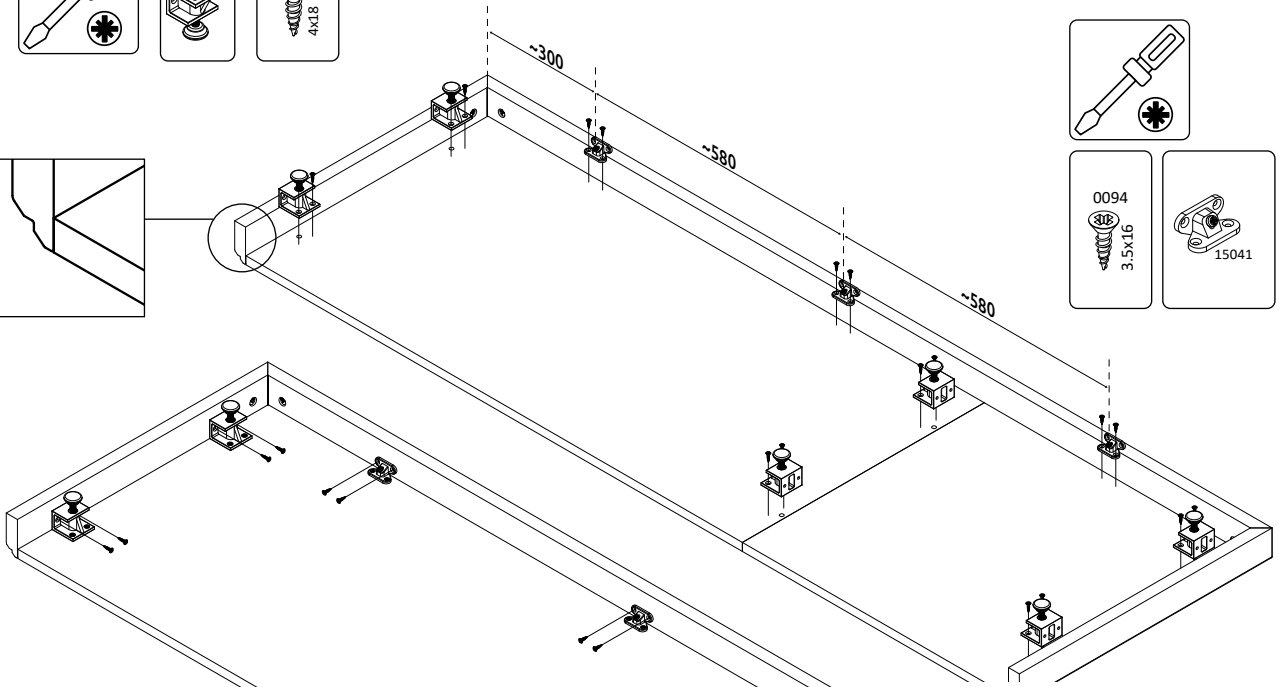
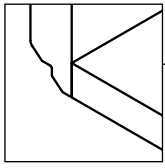
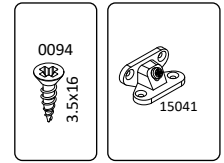
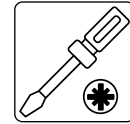
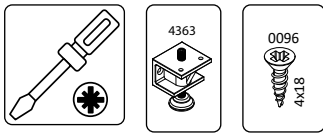

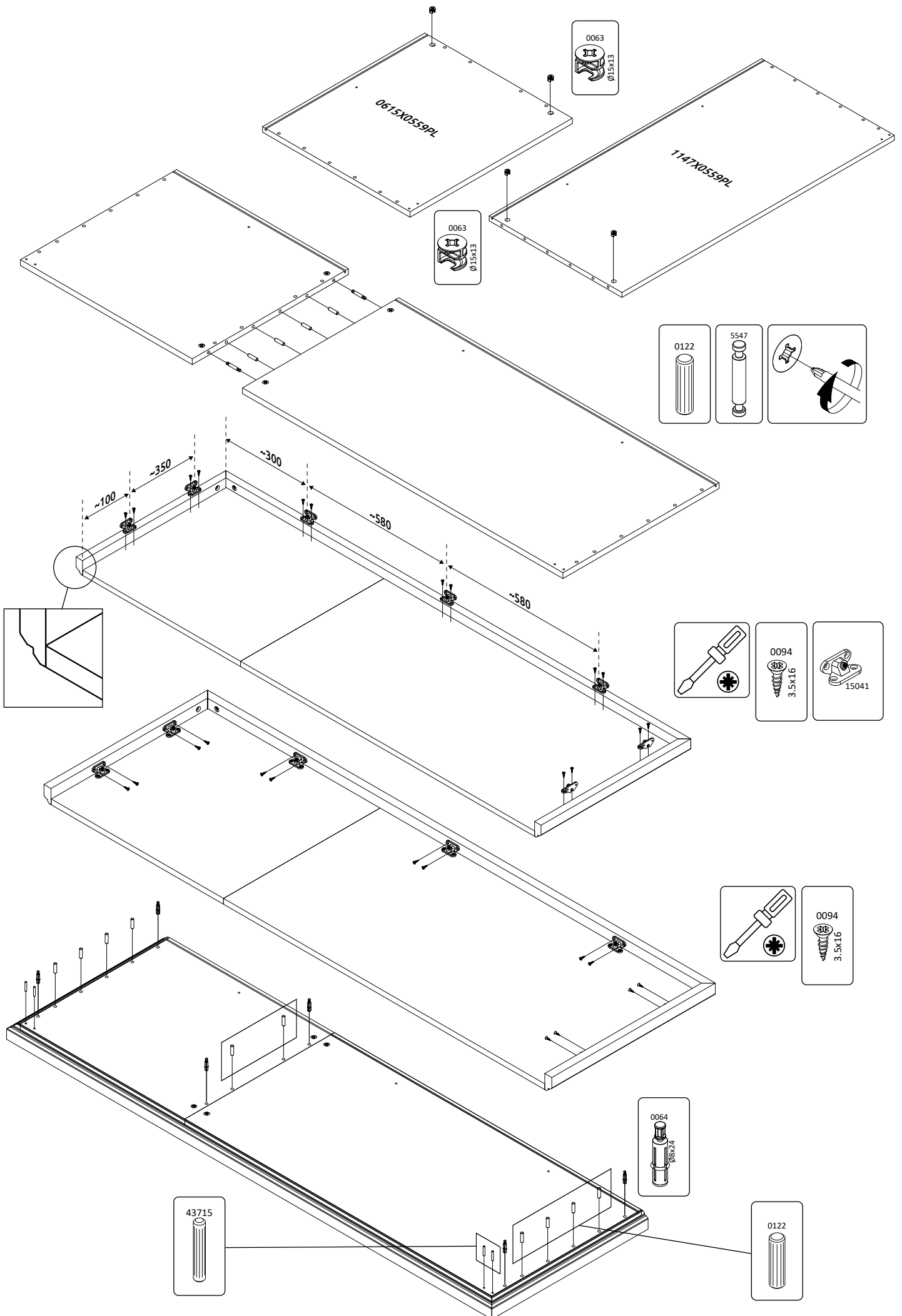

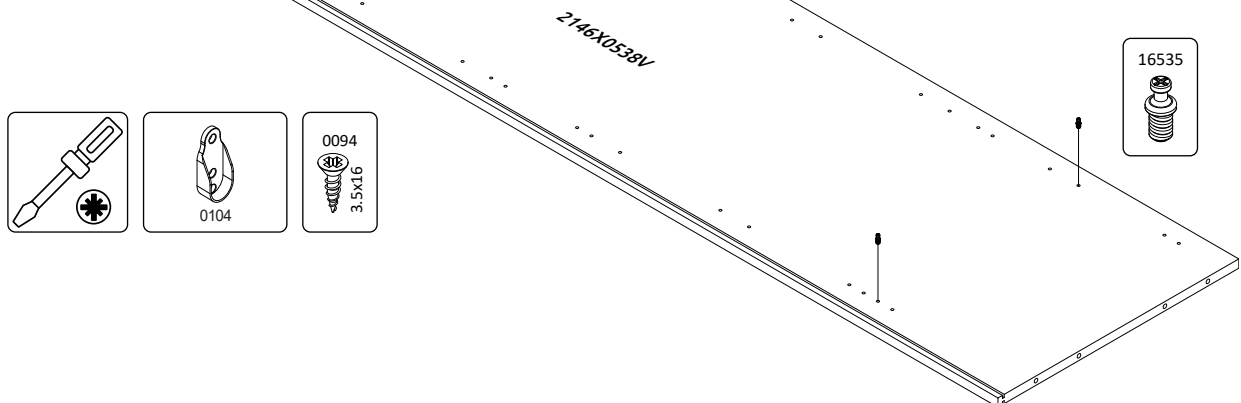
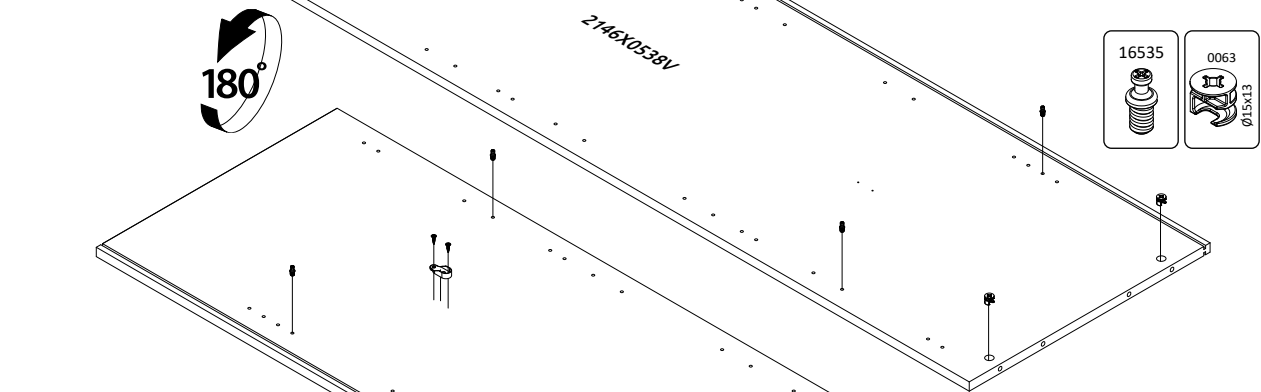
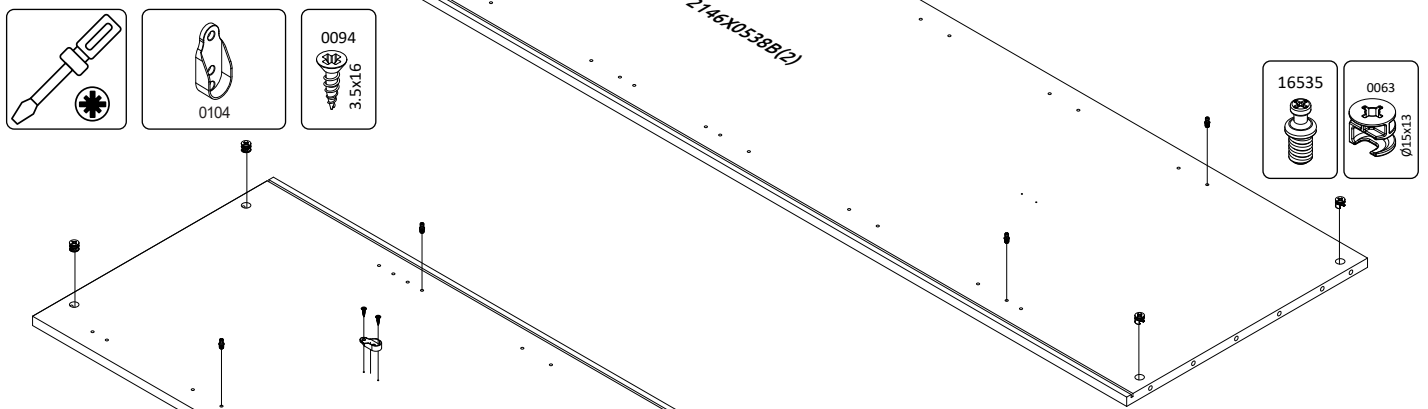
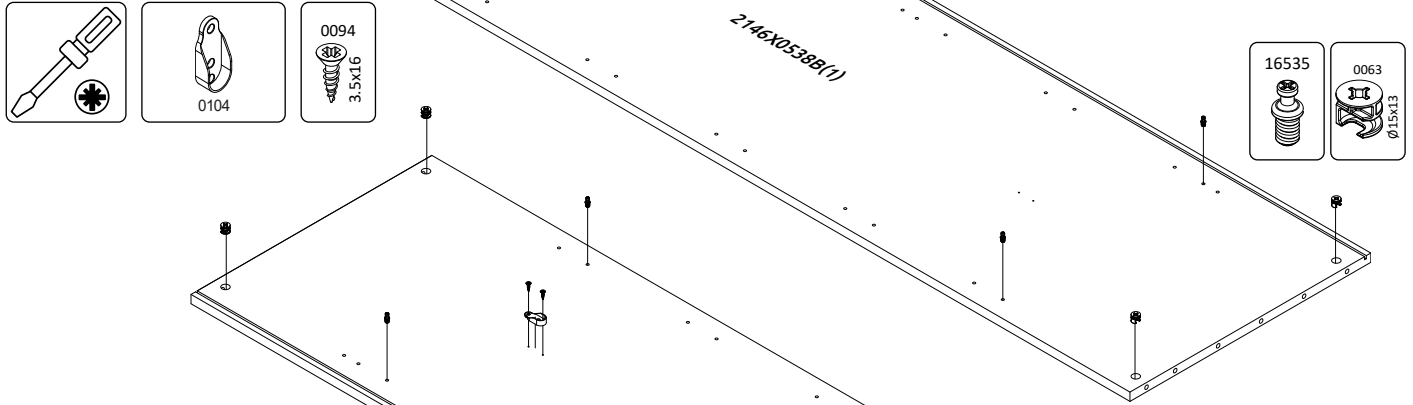
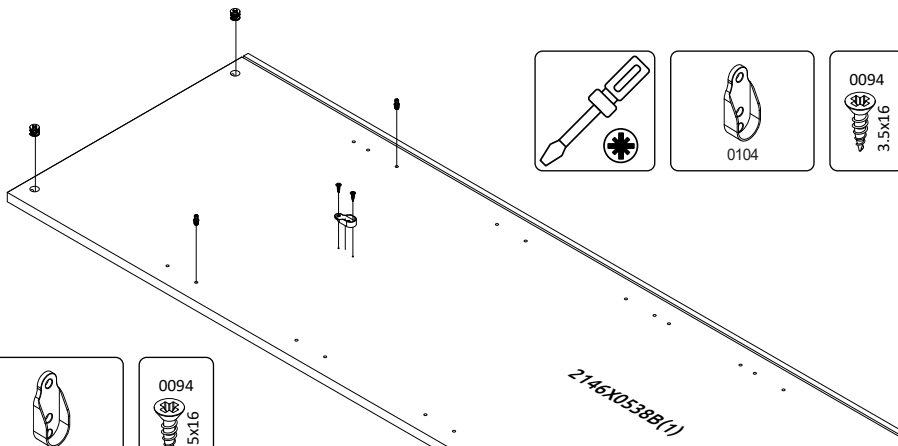

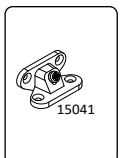
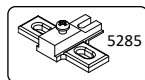
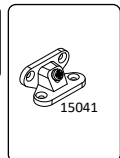
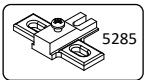
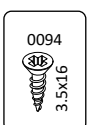
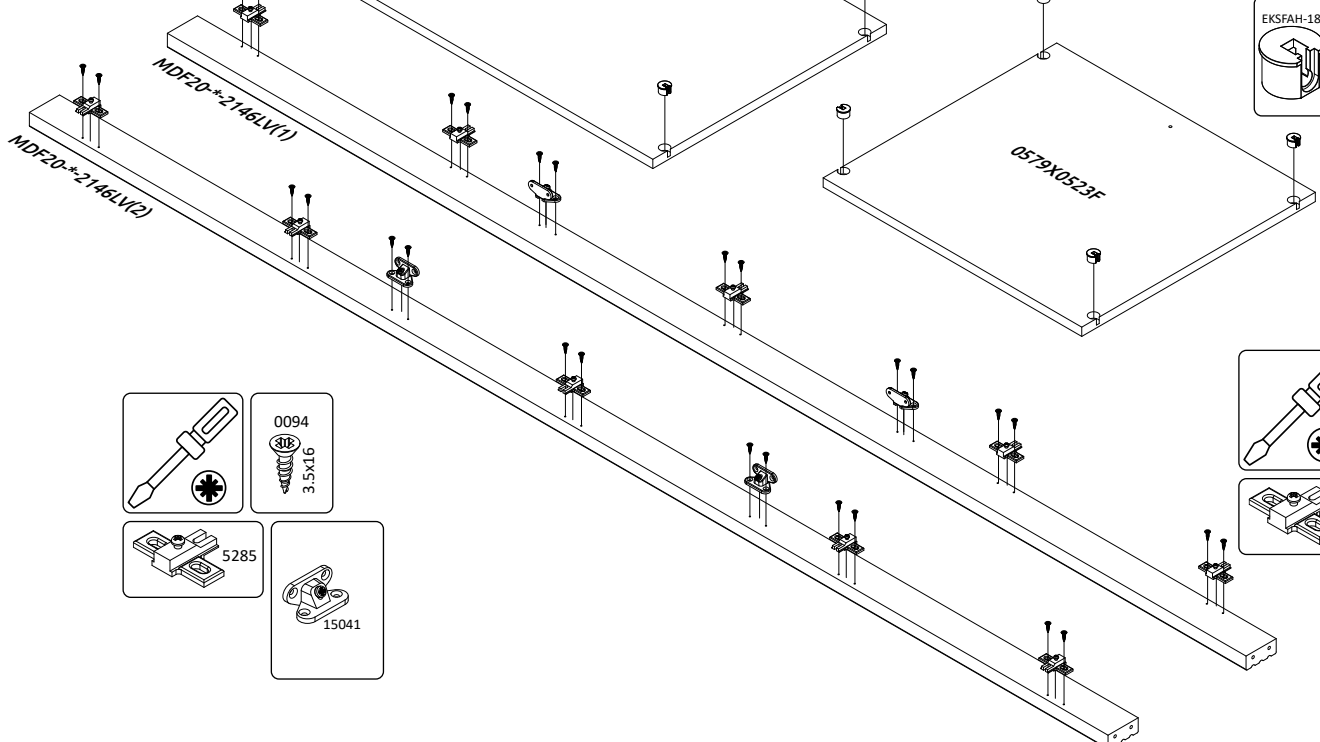
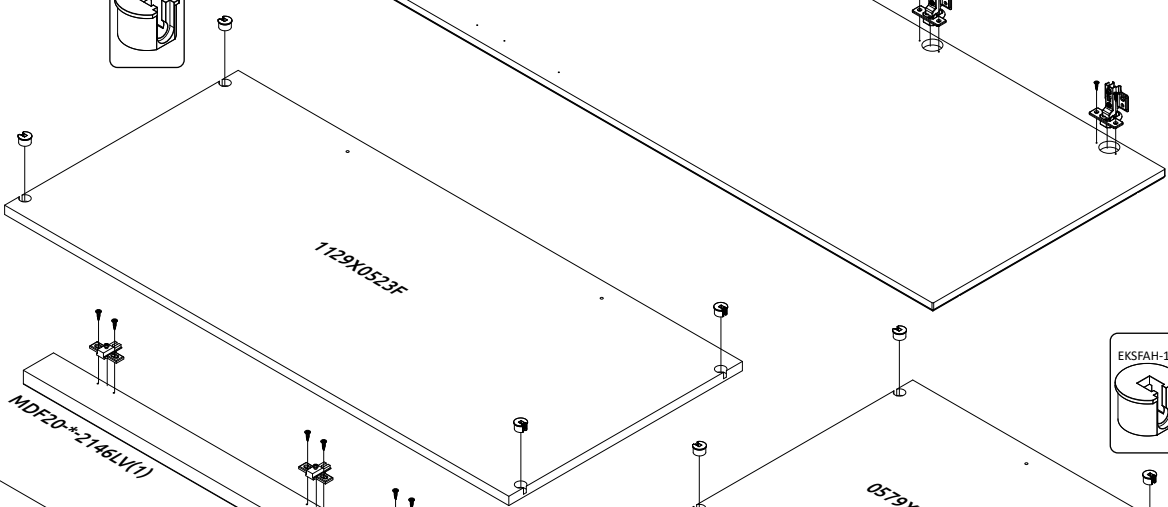
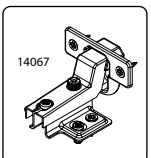
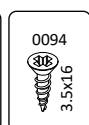
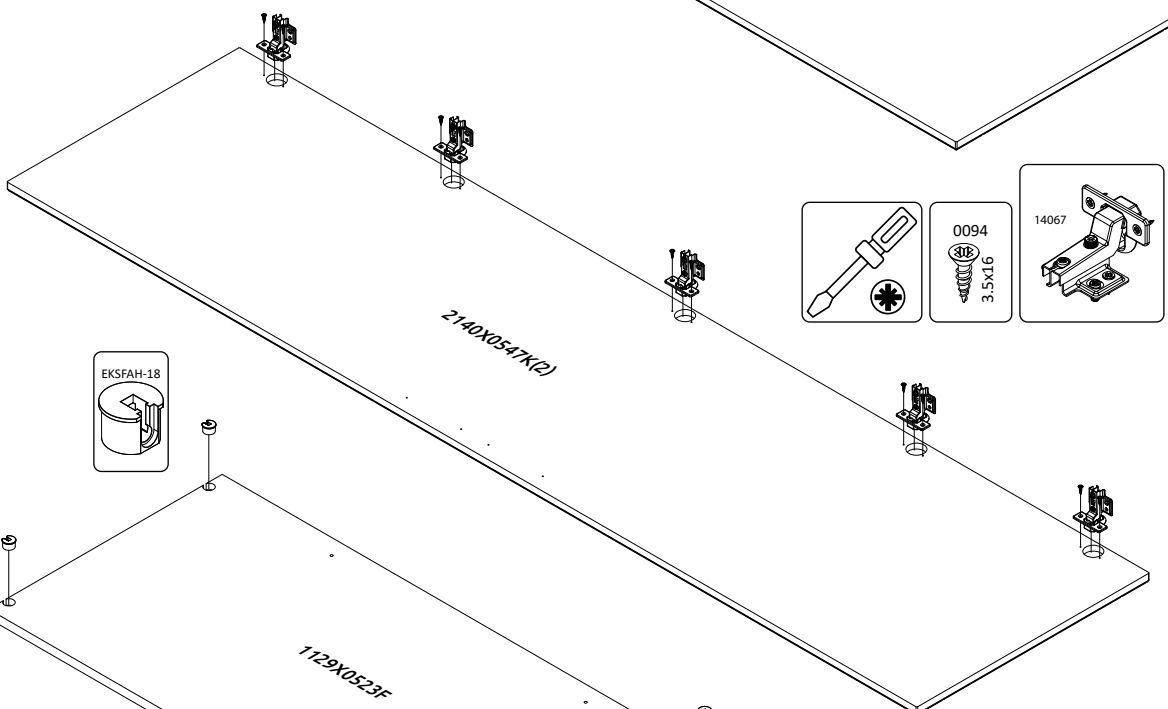
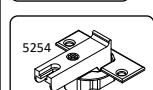
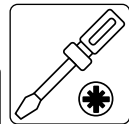
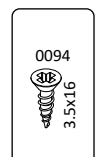
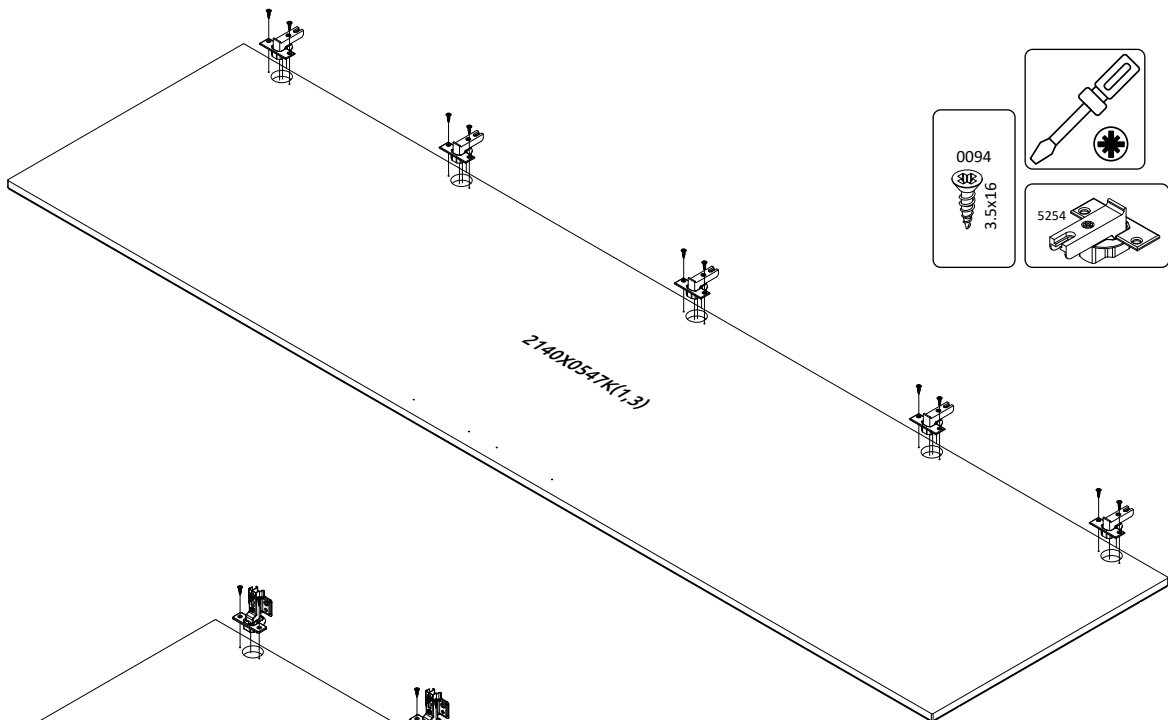

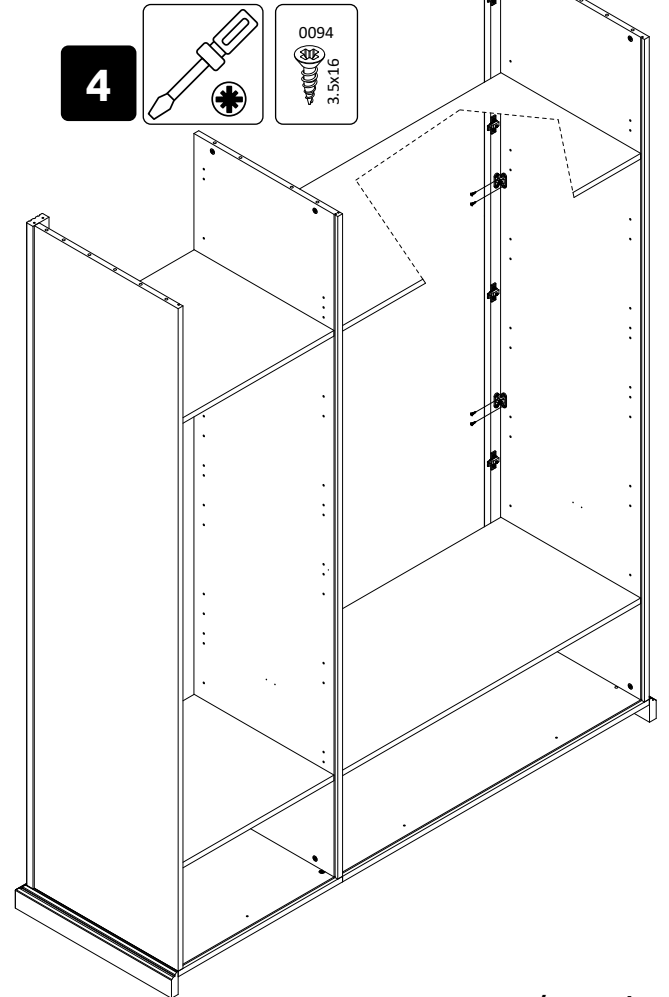
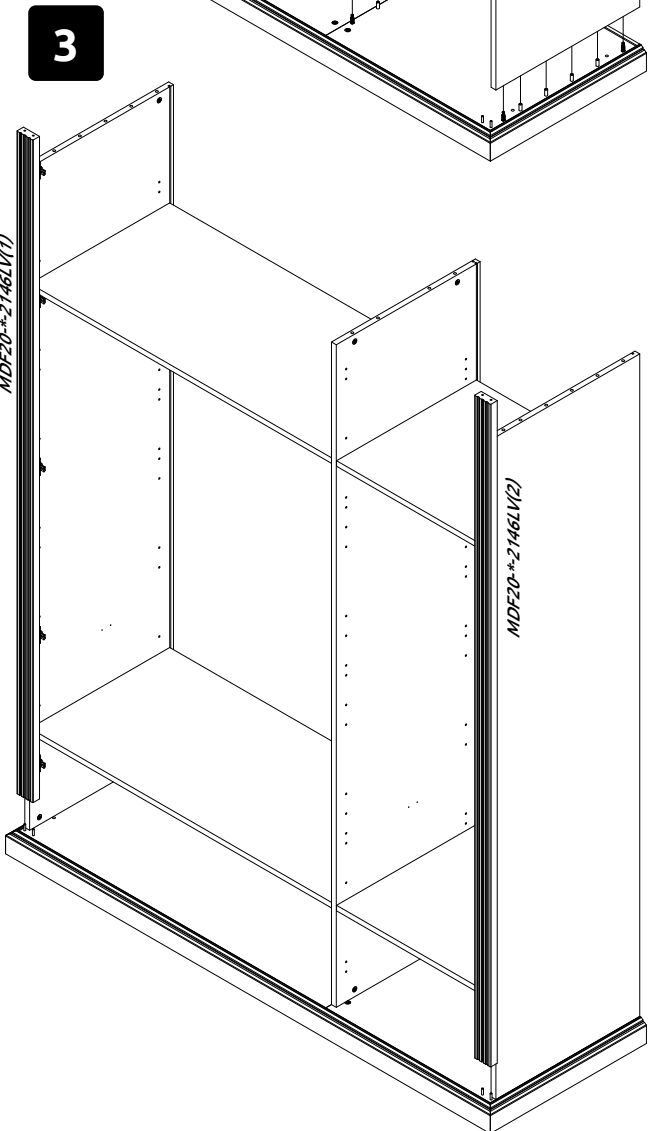
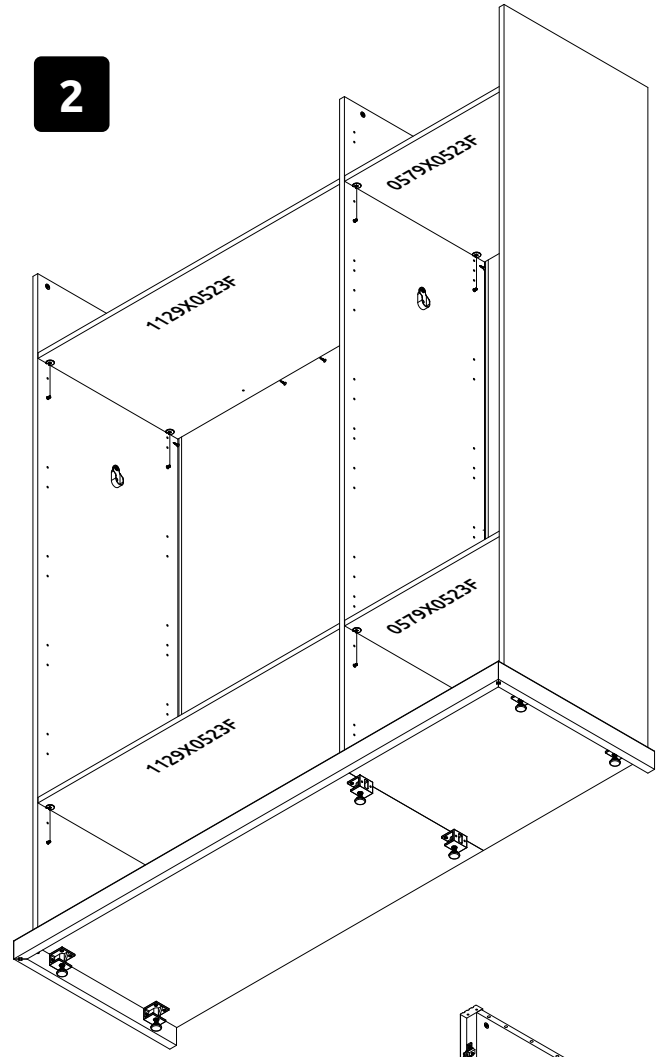
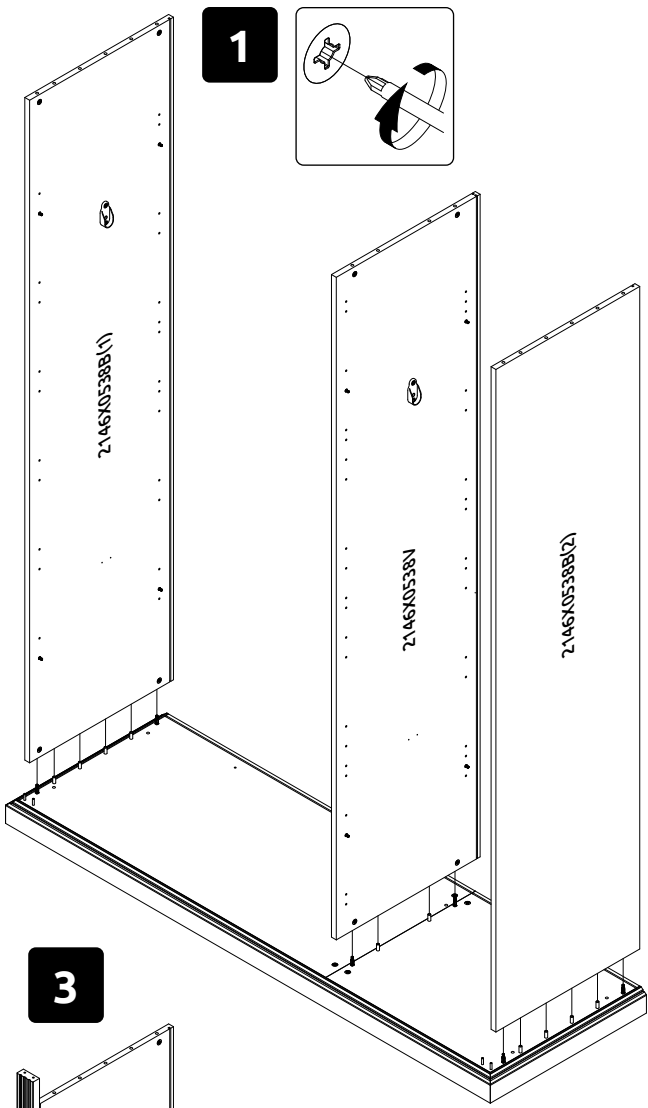

5

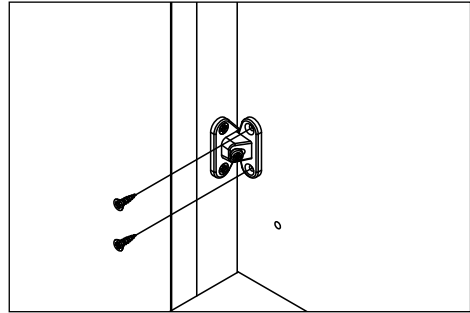
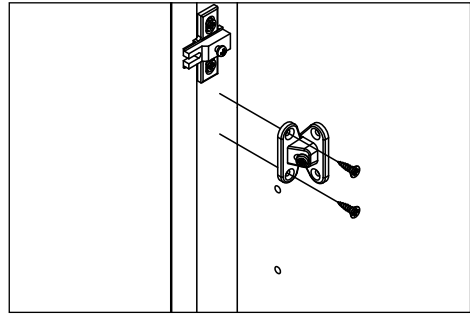
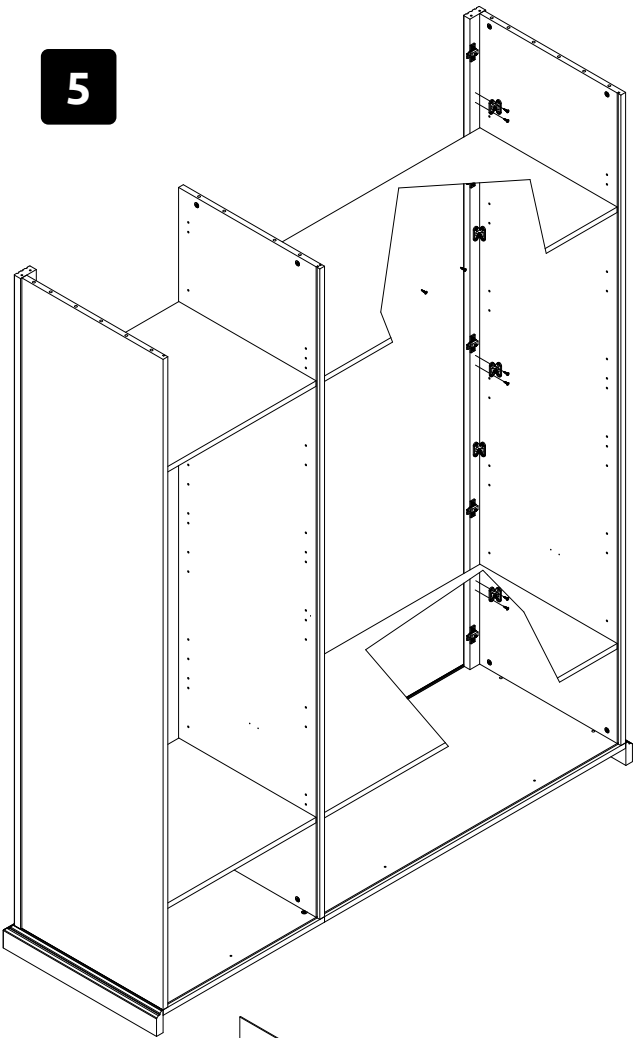

6

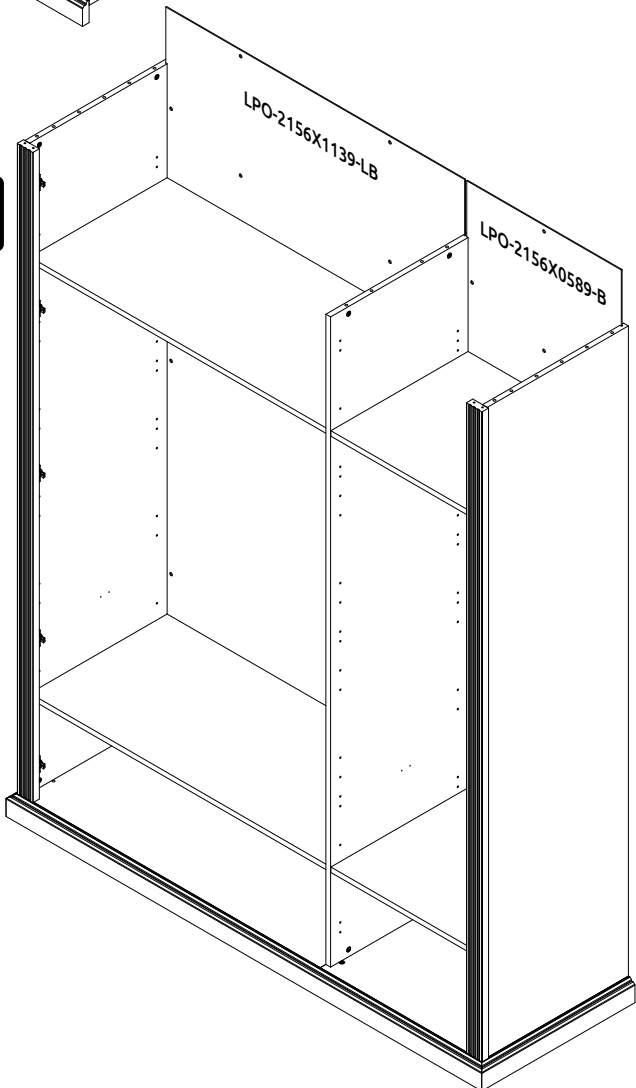

7

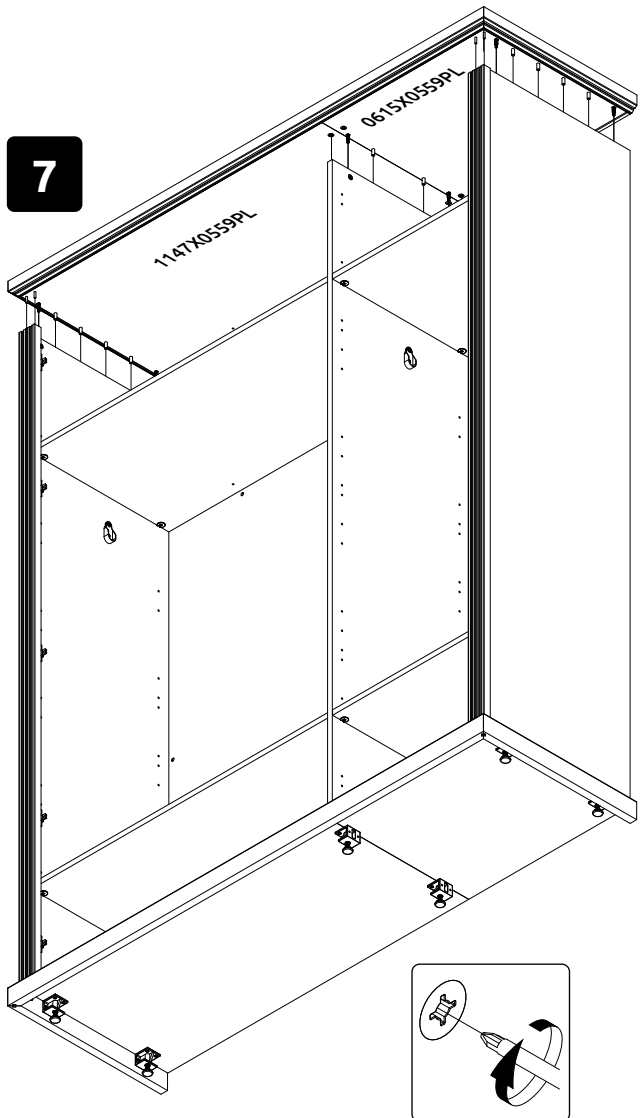

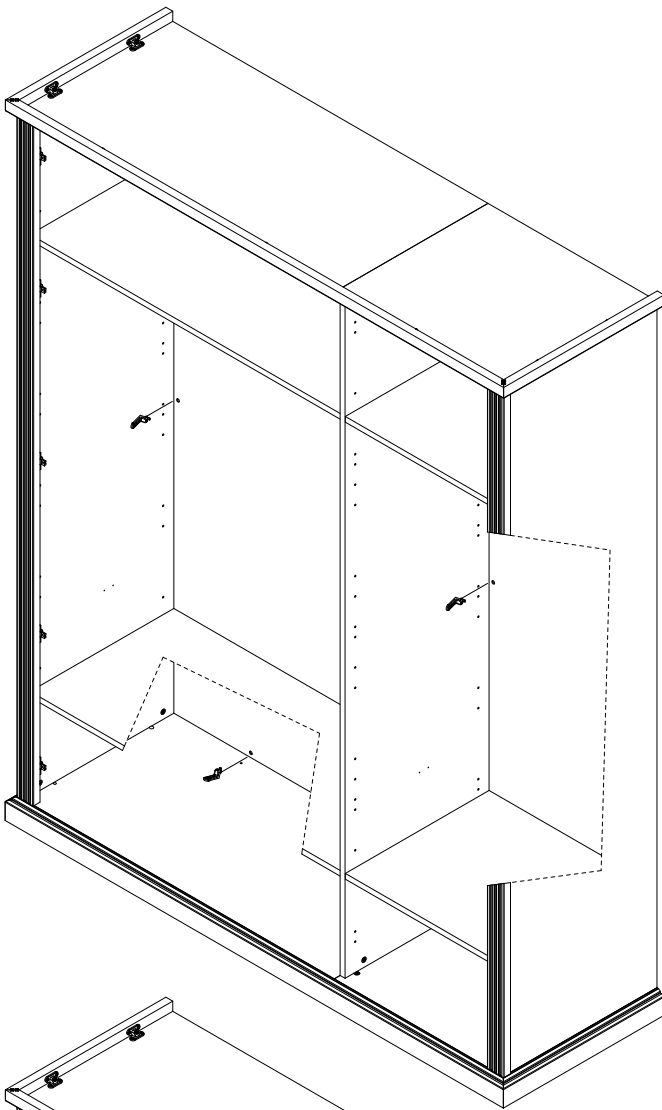

8

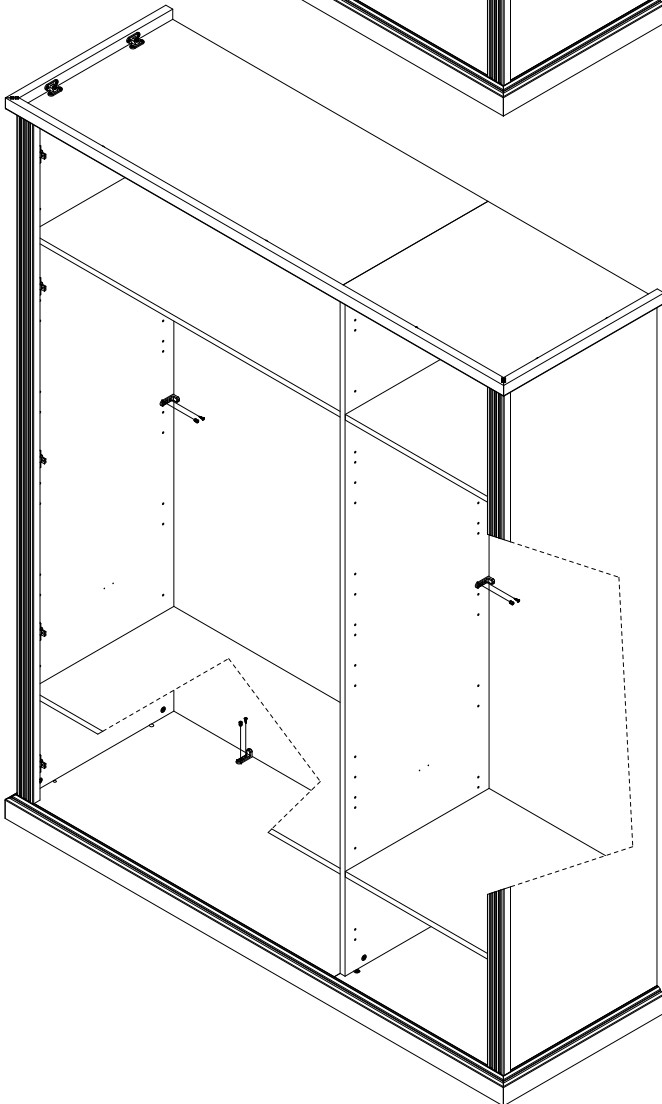
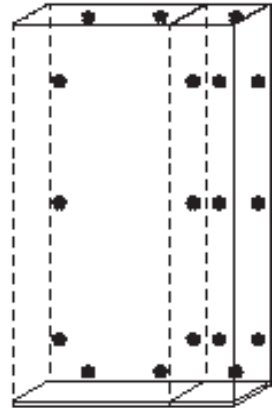
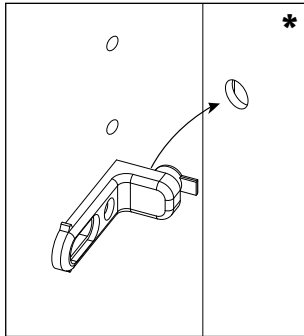
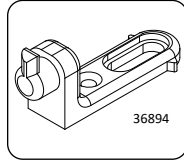

9

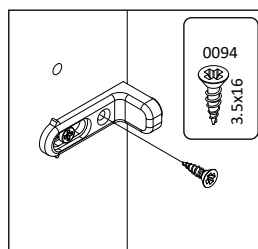
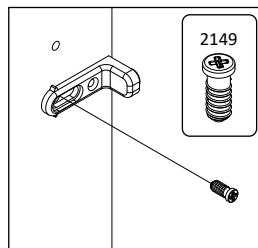
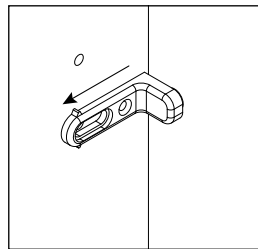

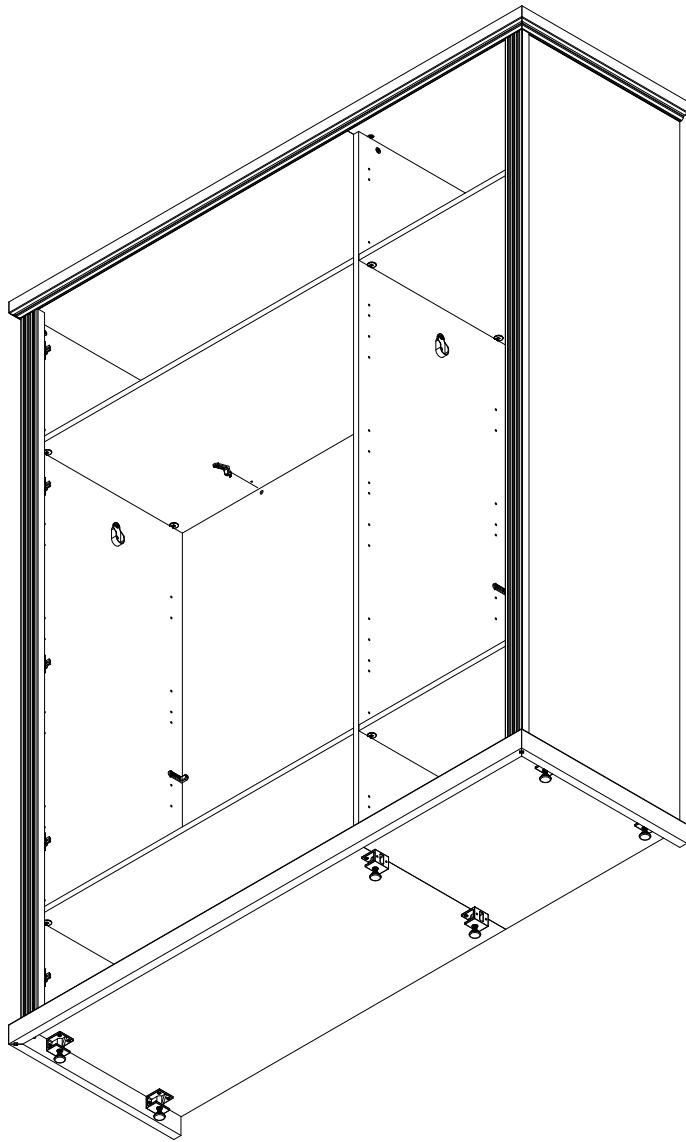

10

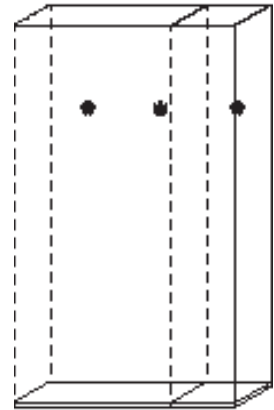
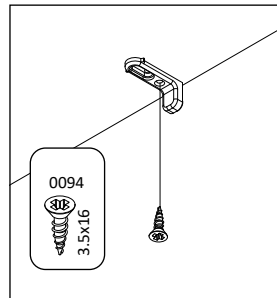
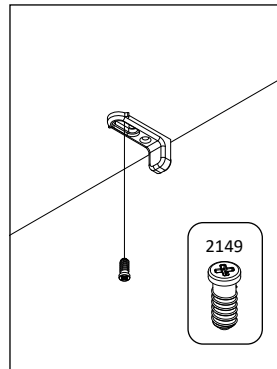
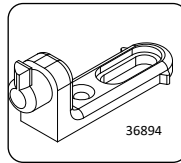

11

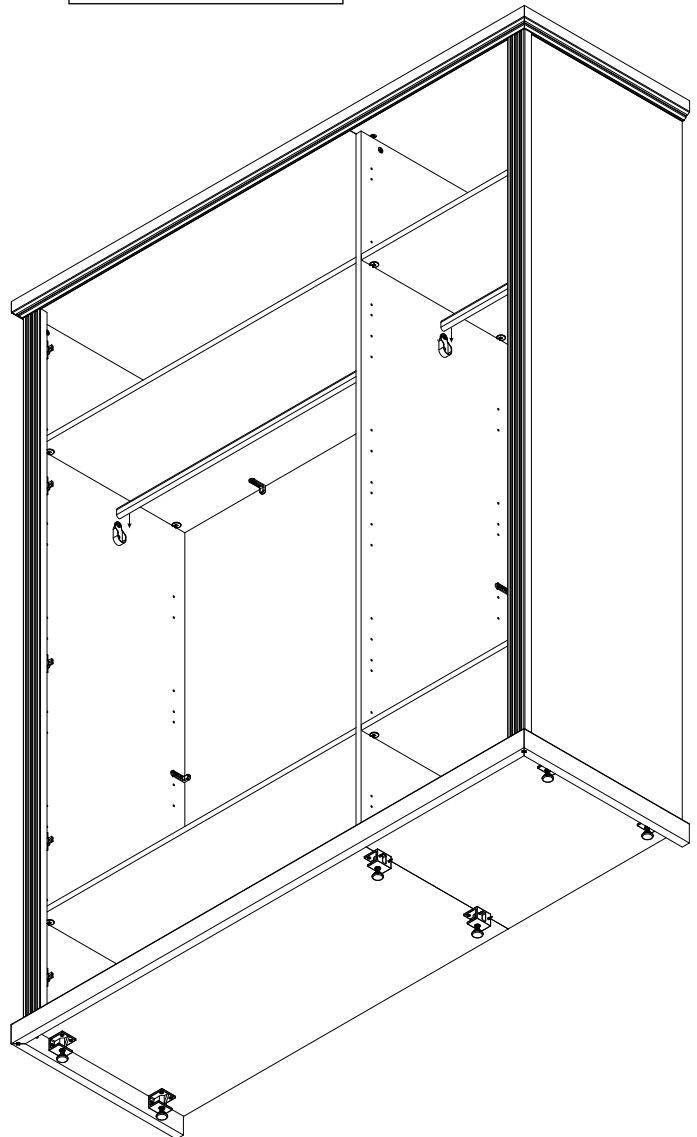

12

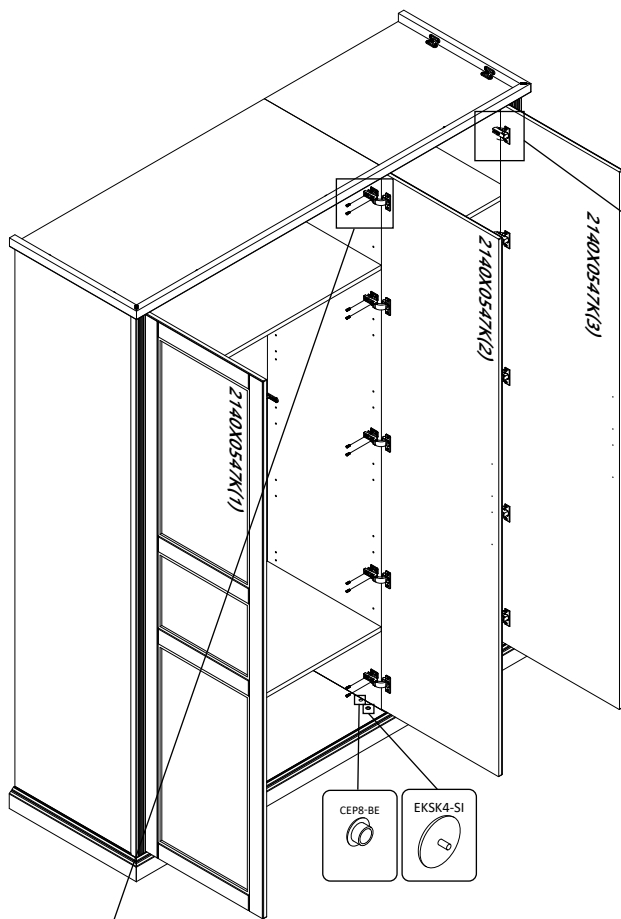
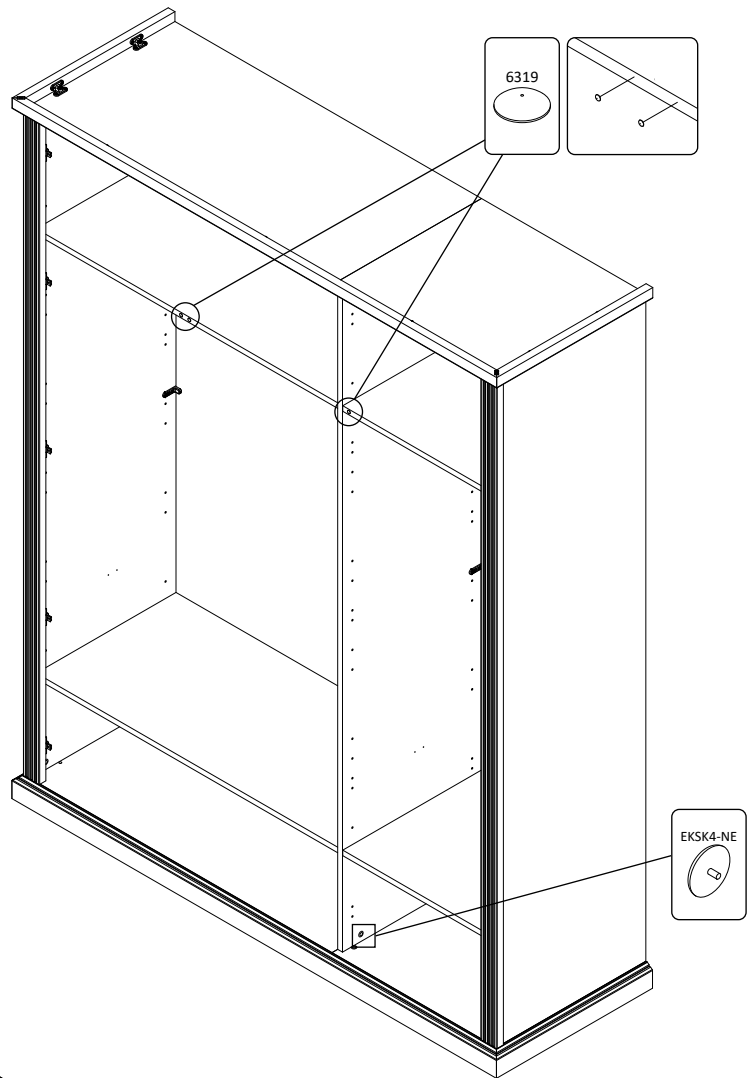
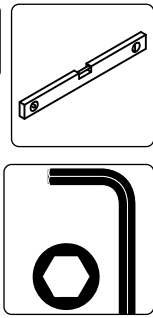

13

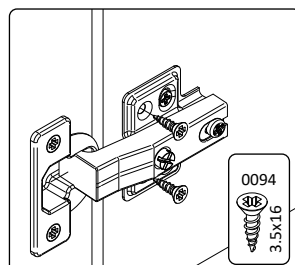
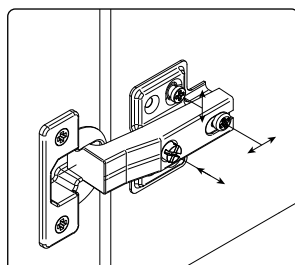
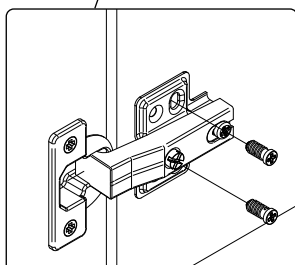
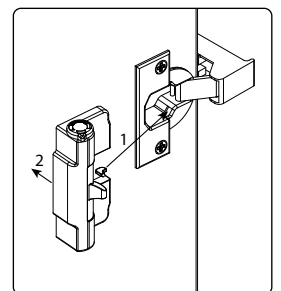
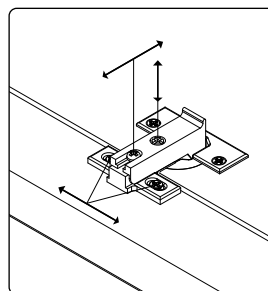
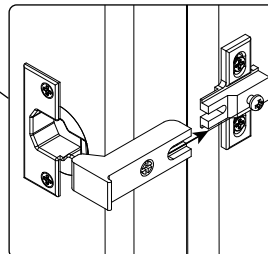

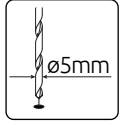

14

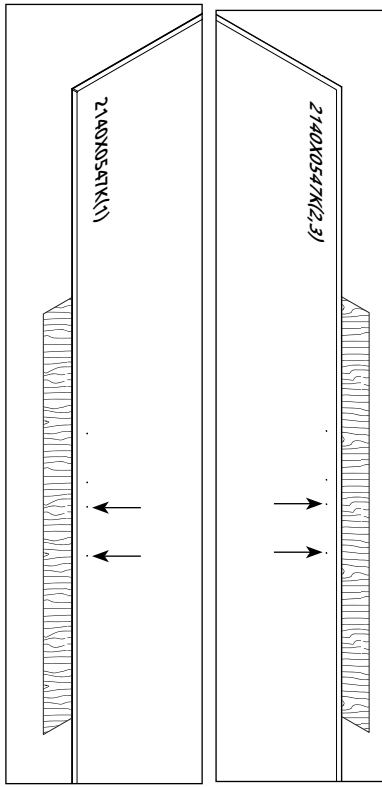

15

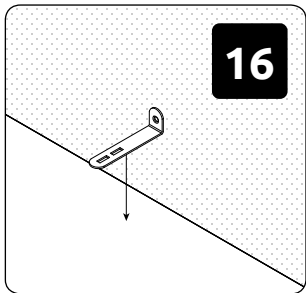
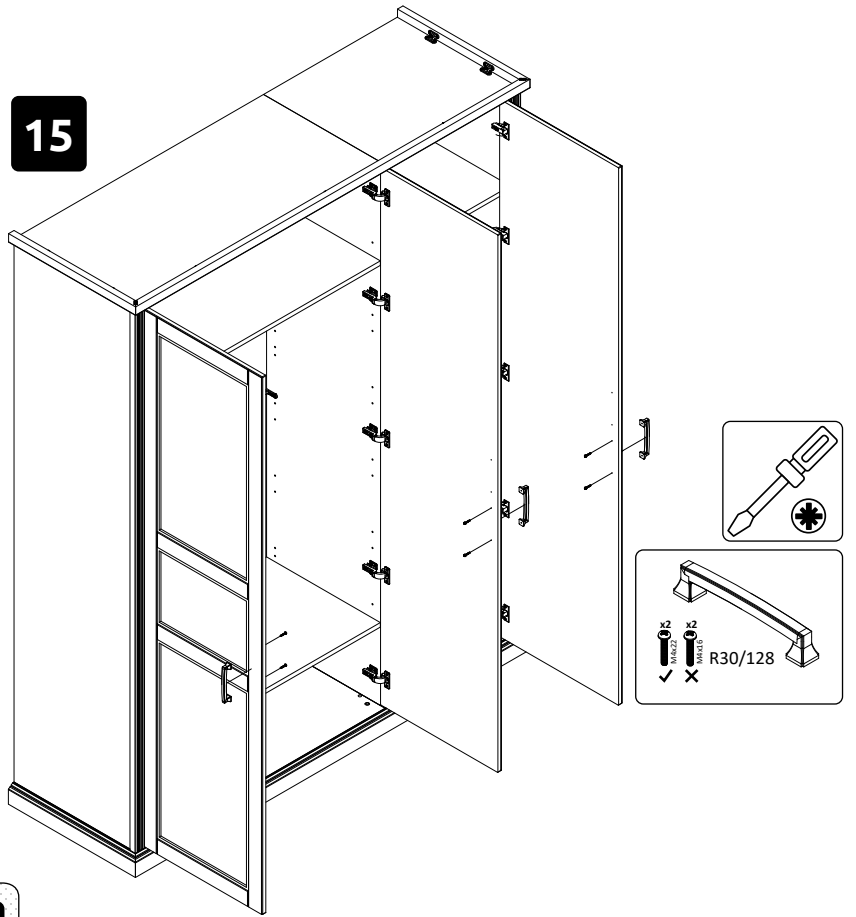

16

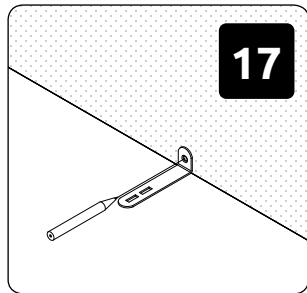

17

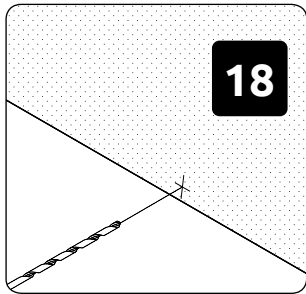

18

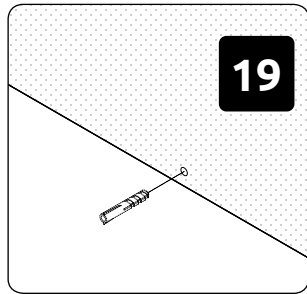

19

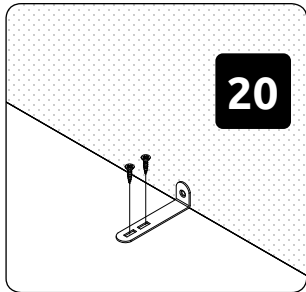

20

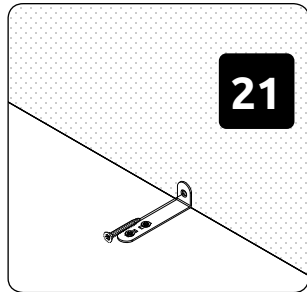

21

