

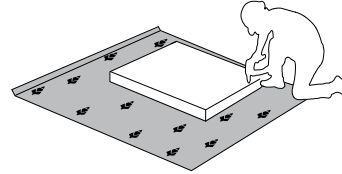

IMPORTANT - READ CAREFULLY - RETAIN FOR FUTURE REFERENCE  
WICHTIG - SORGFÄLTIG LESEN UND AUFBEWAHREN

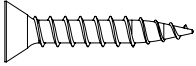

**DP2-AR**  
LWH - 900x555x2236

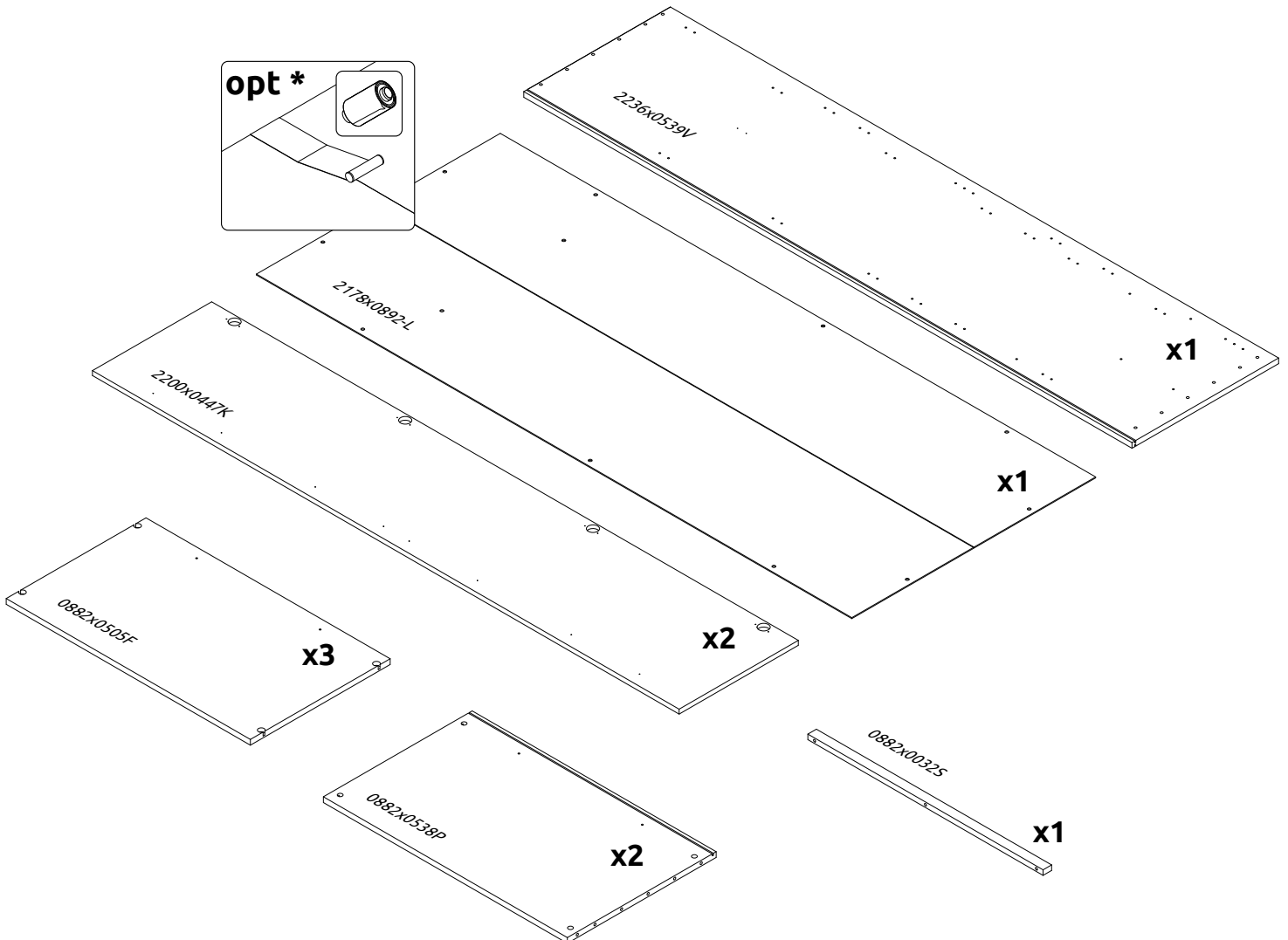
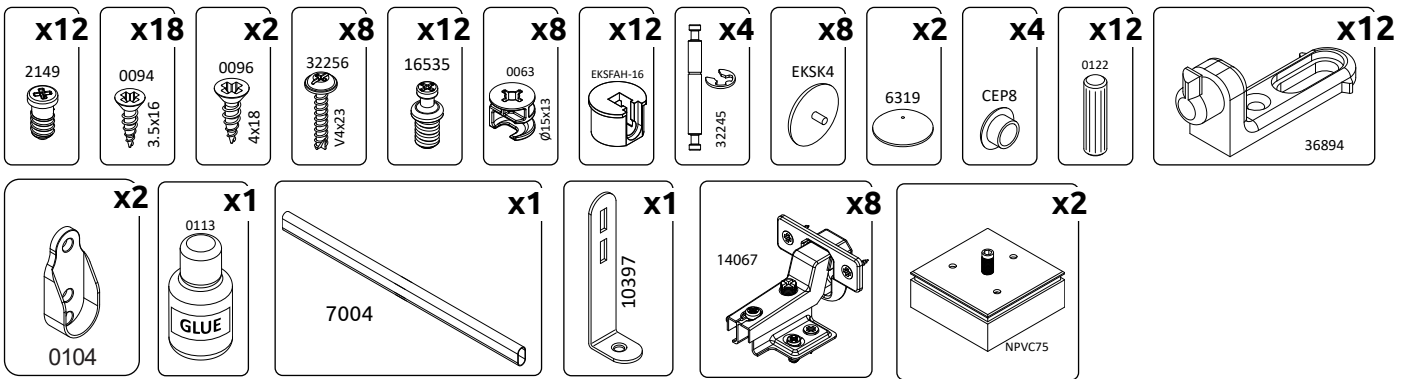

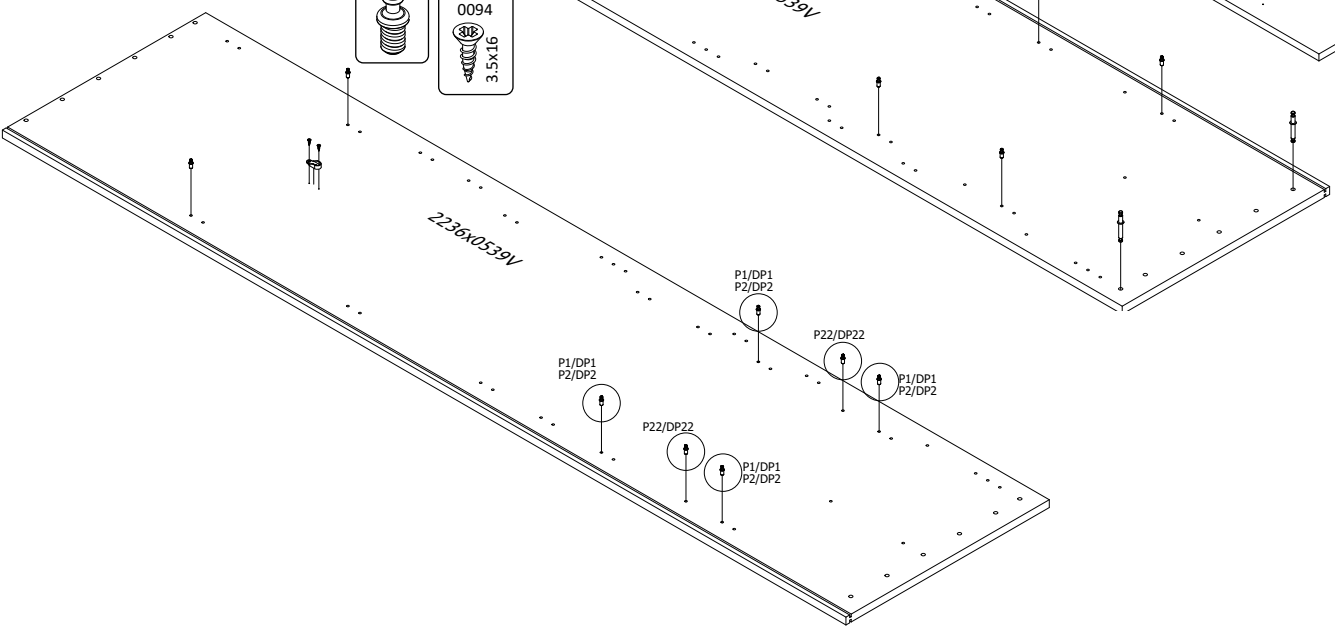
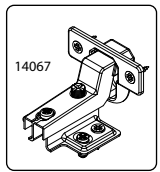
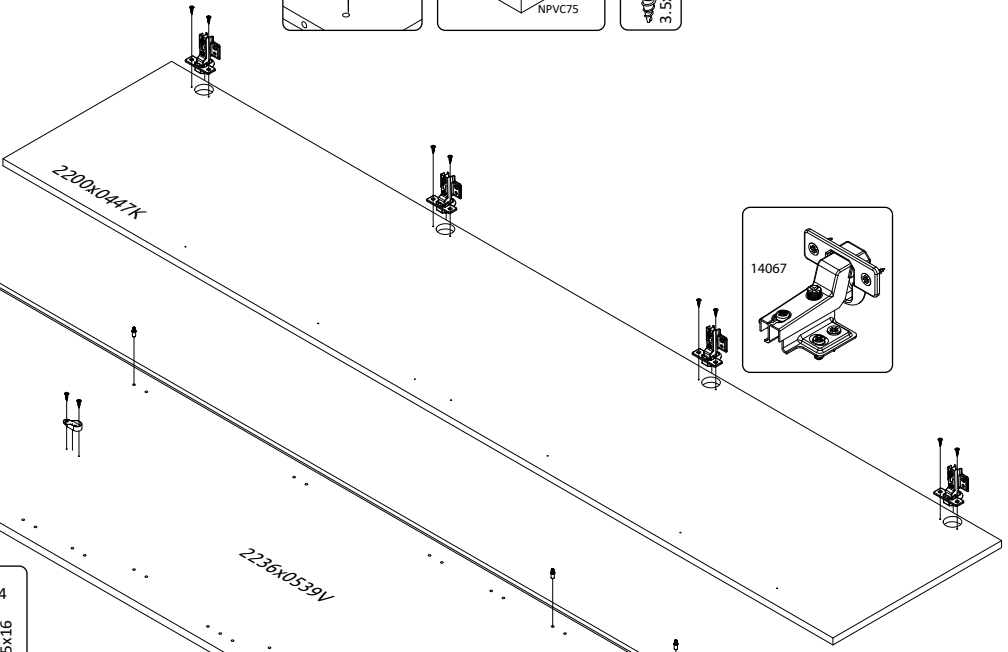
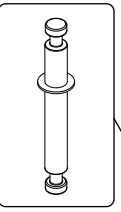
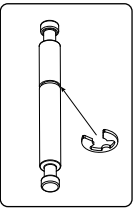
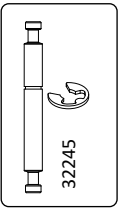
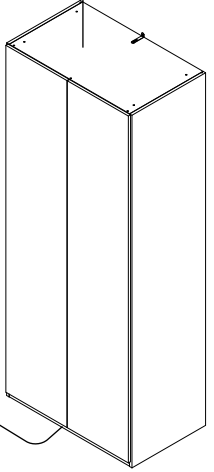
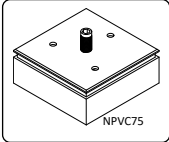
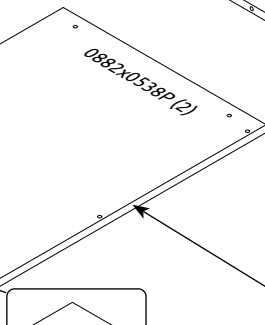
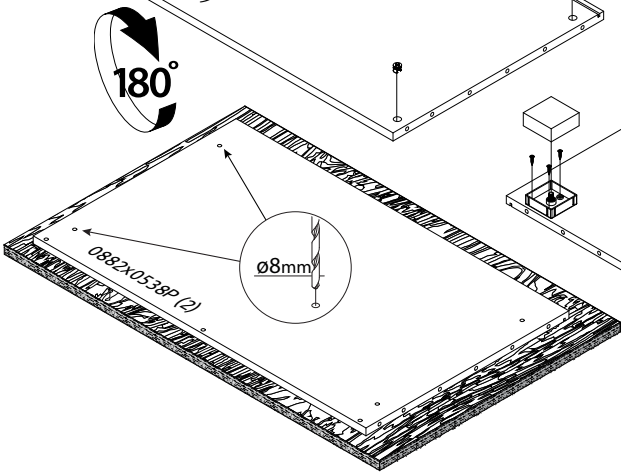
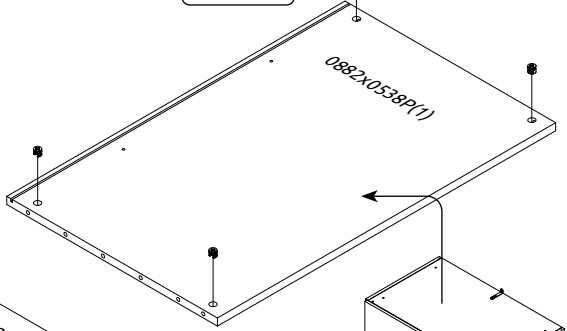
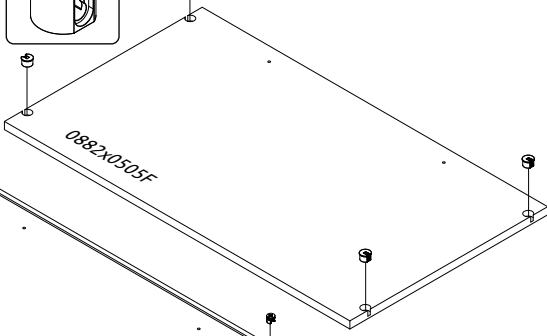

P1/DP1  
P2/DP2

P1/DP1  
P2/DP2

P22/DP22

P1/DP1  
P2/DP2

P22/DP22

P1/DP1  
P2/DP2

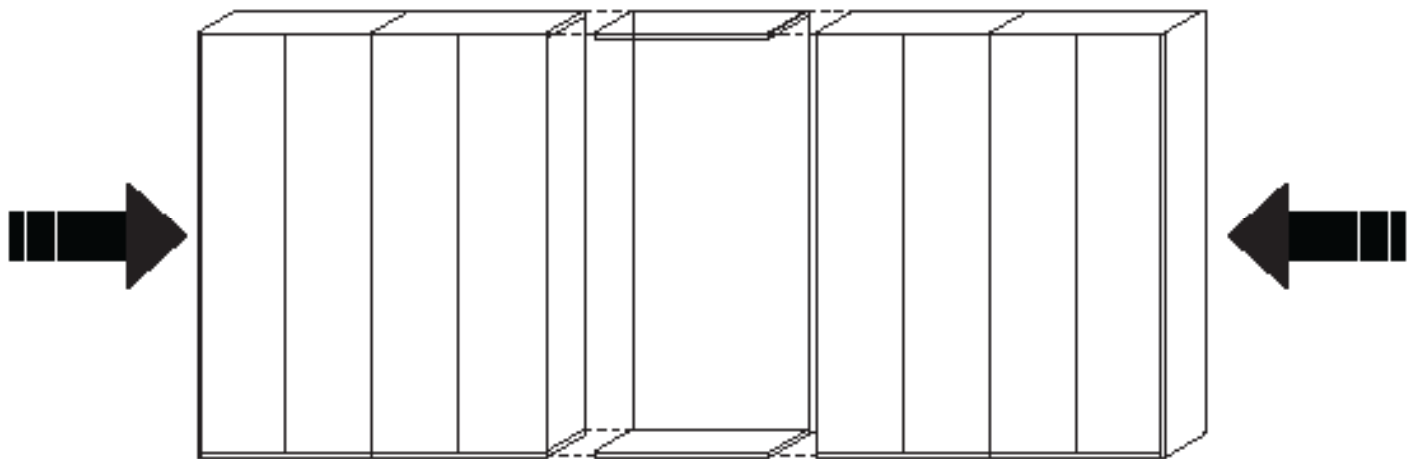
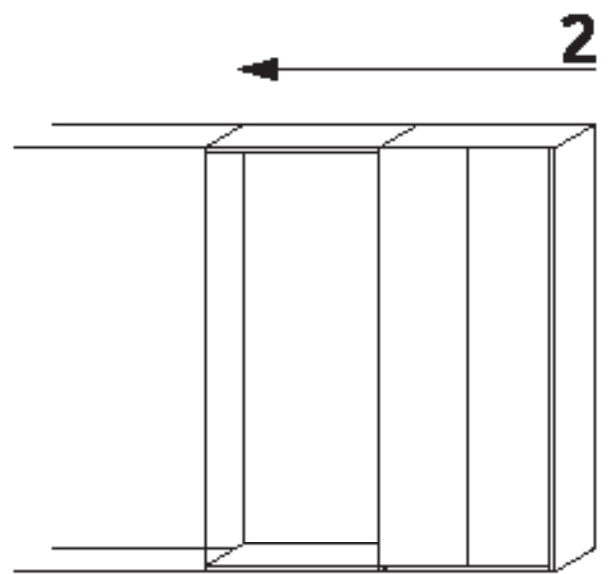
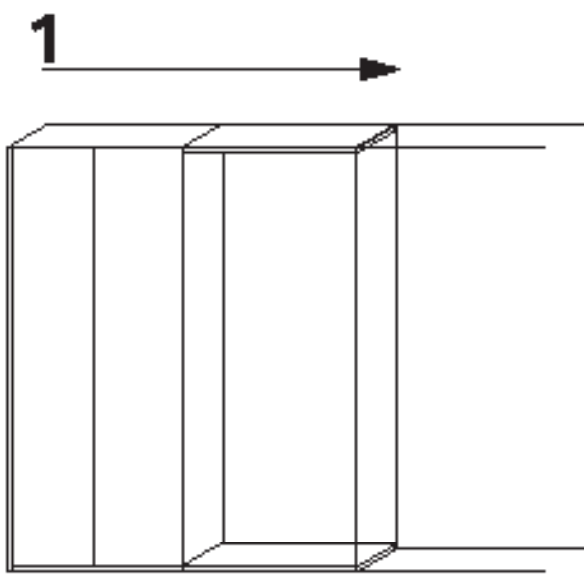
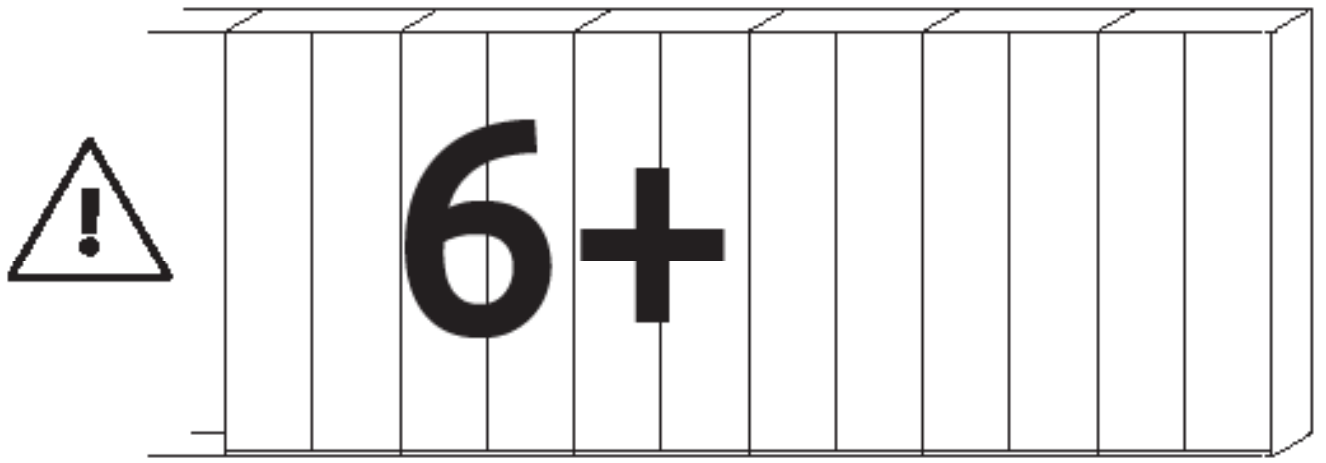

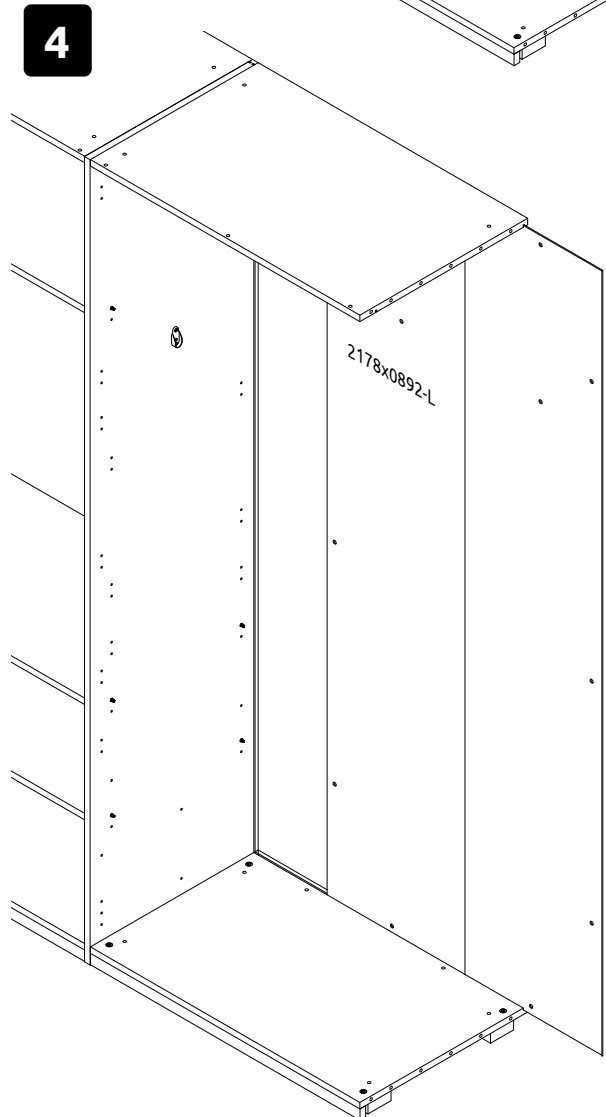
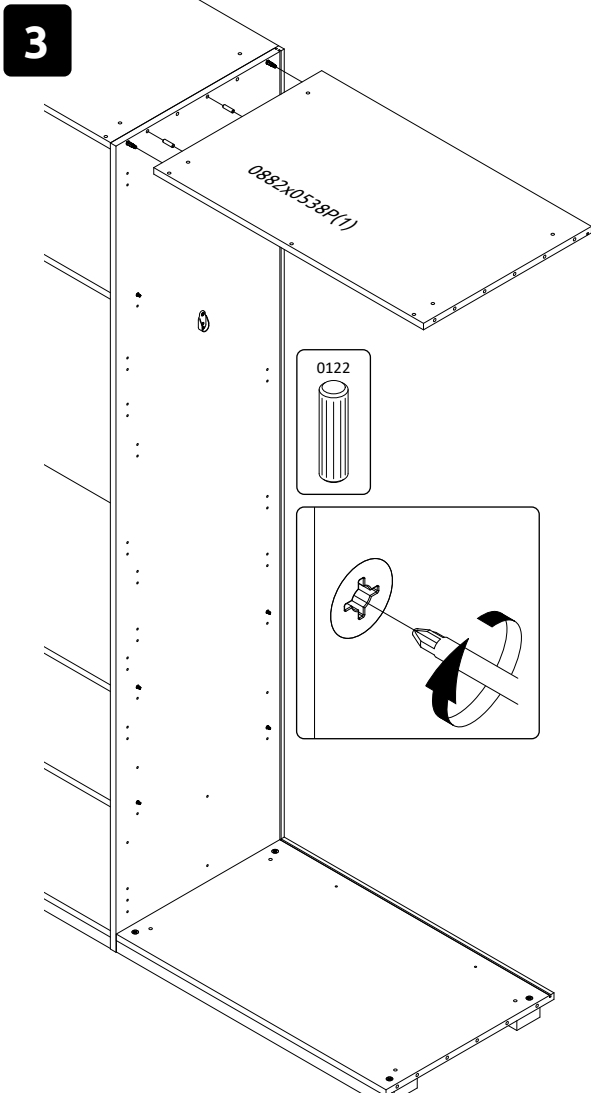
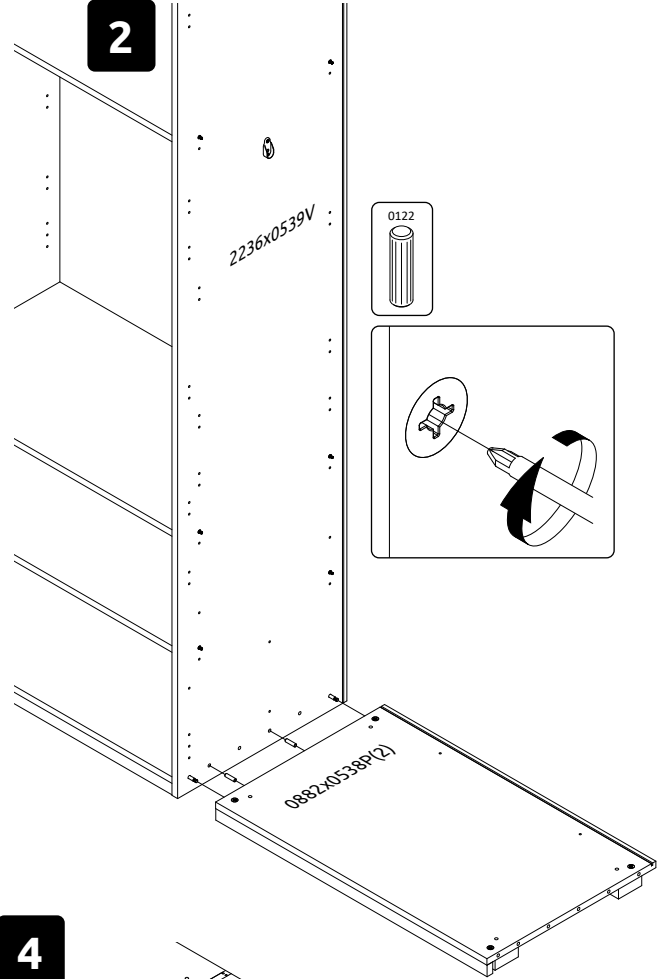
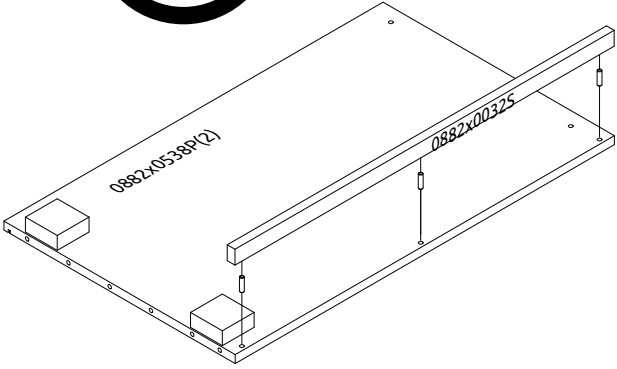
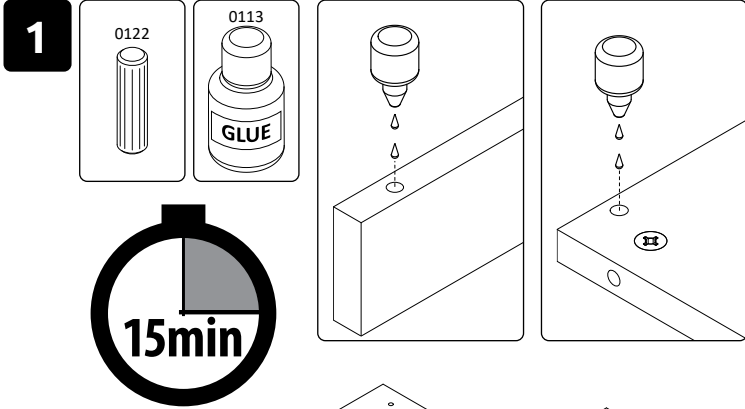

5



opt 1

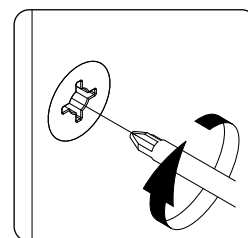
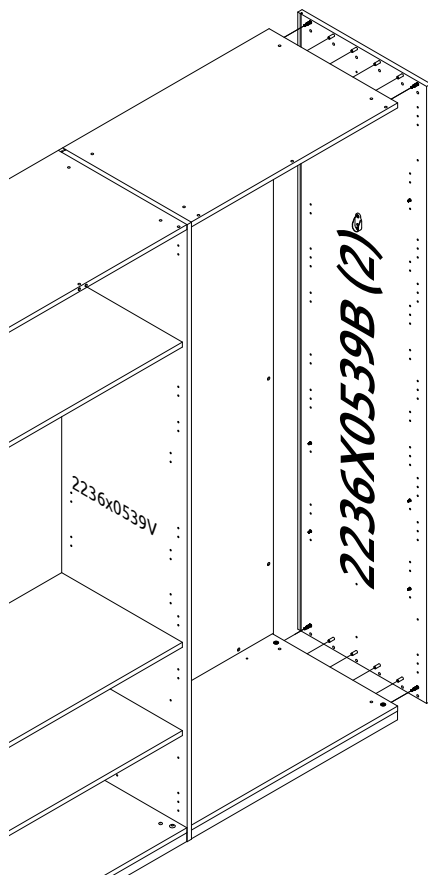
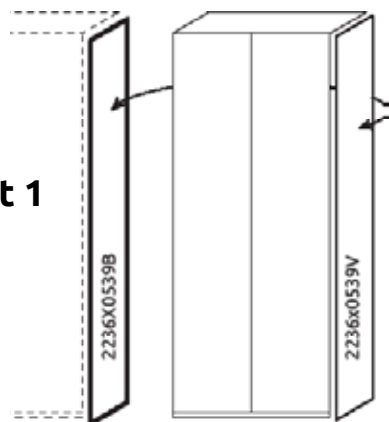

opt 2

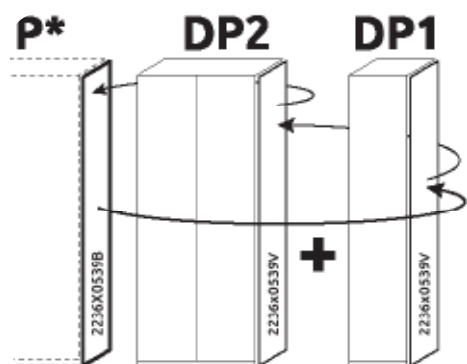

P\* = P1 / P2 / P22 / PUG

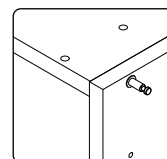
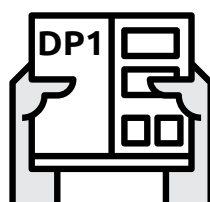

opt 3

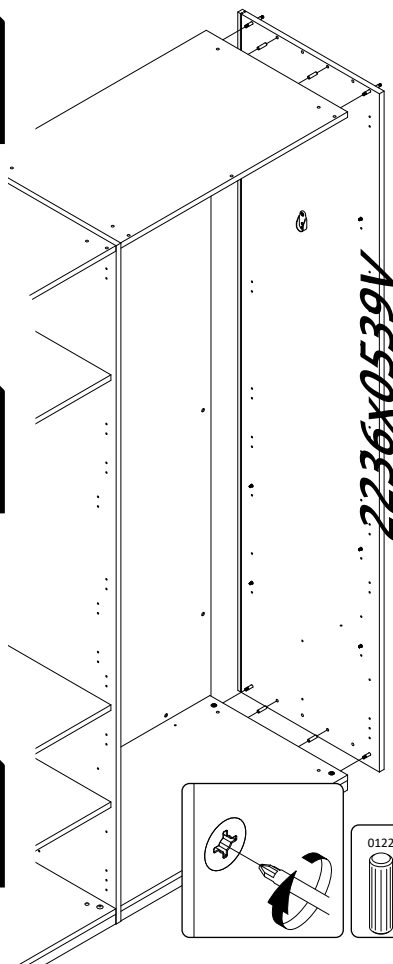
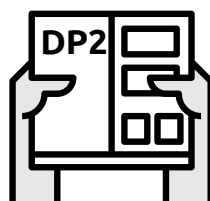
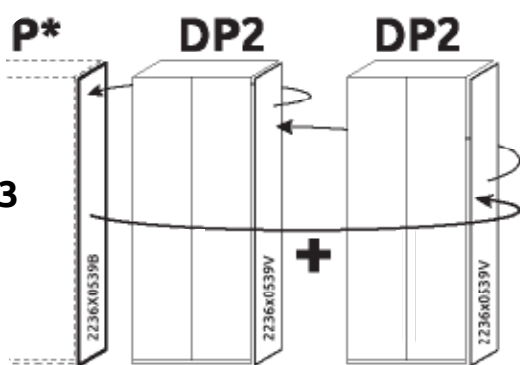

opt 4

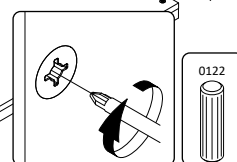
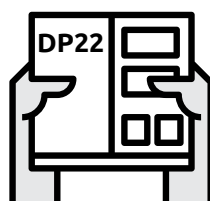
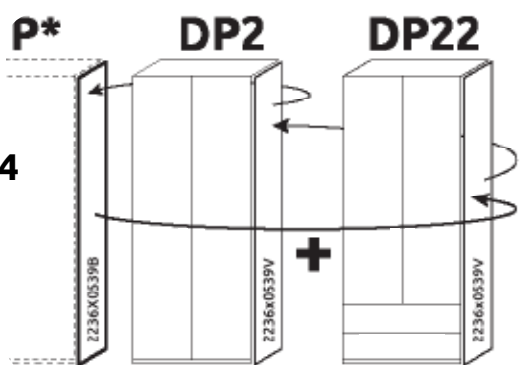

6

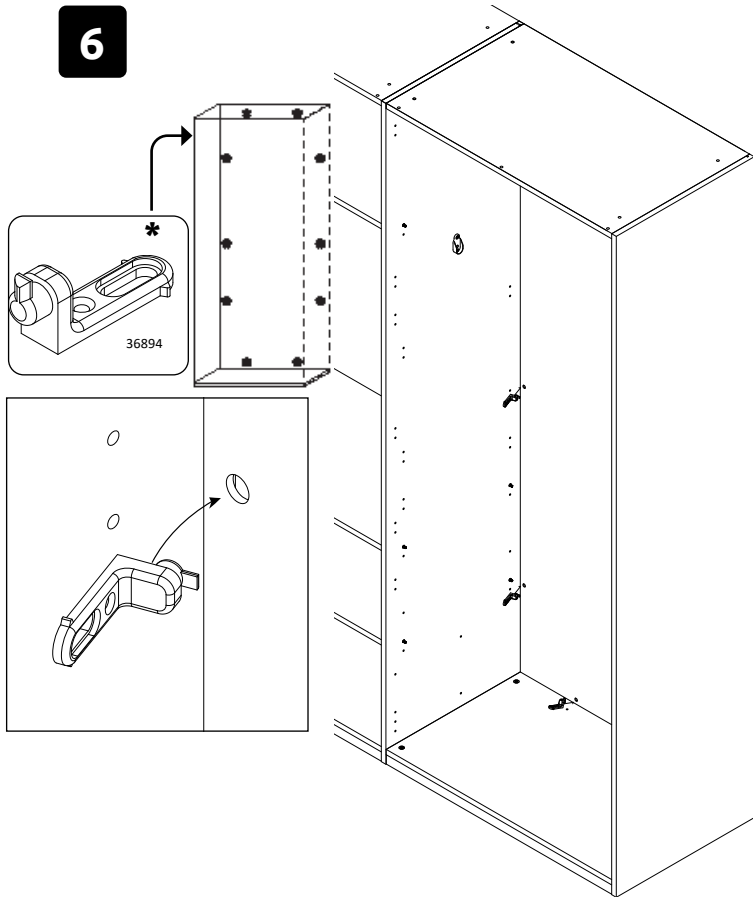

7

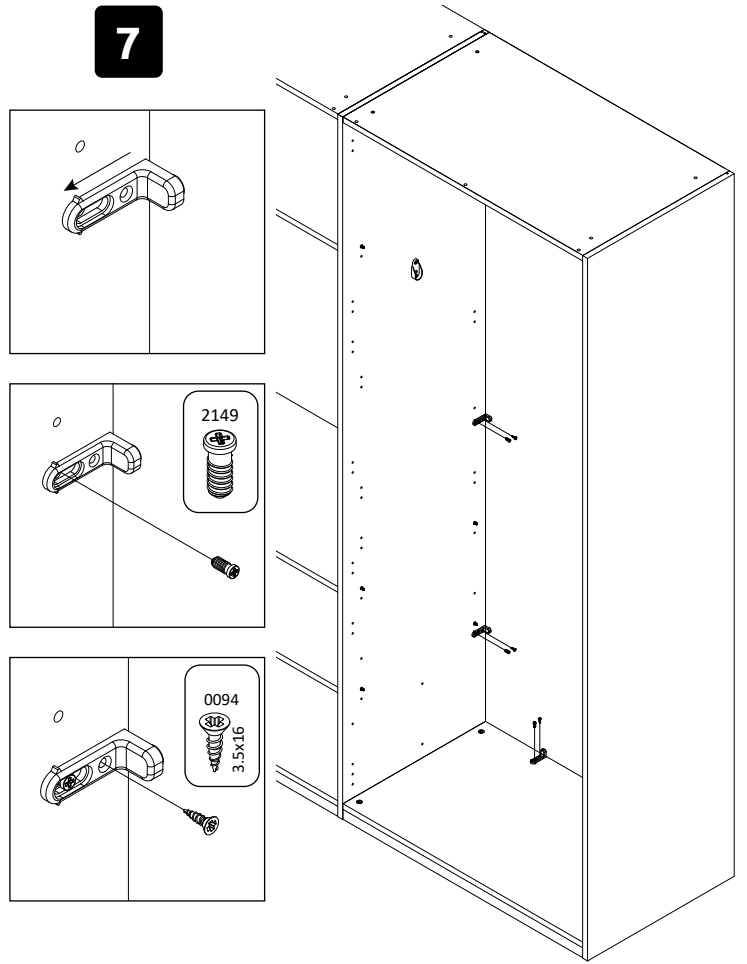

8

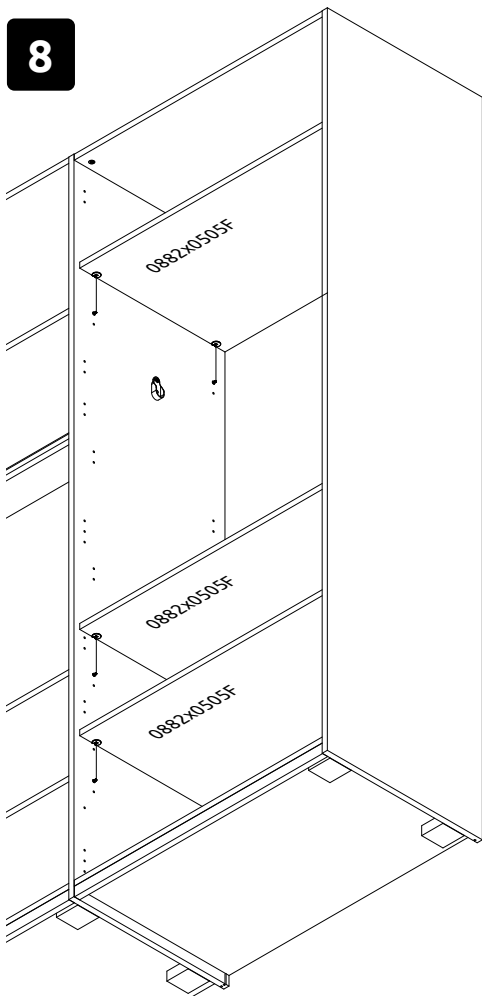

9

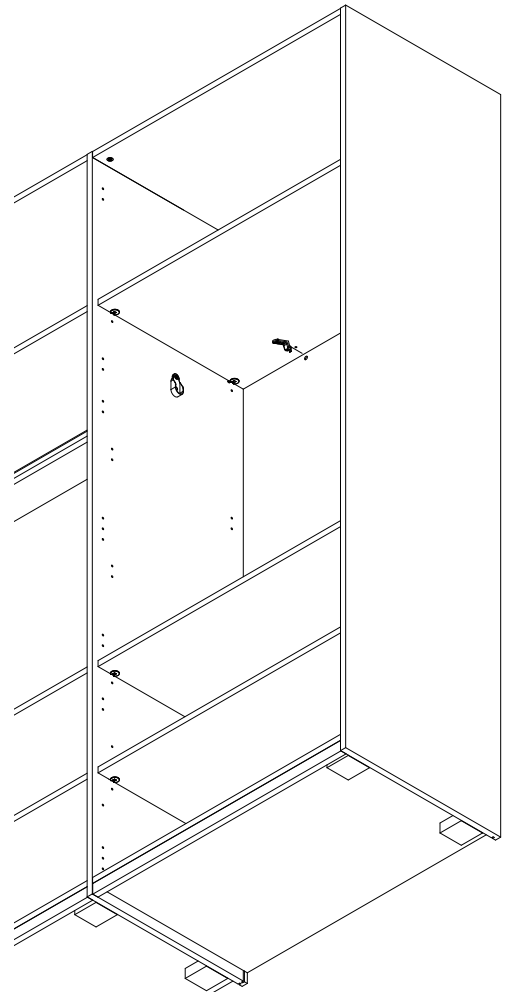
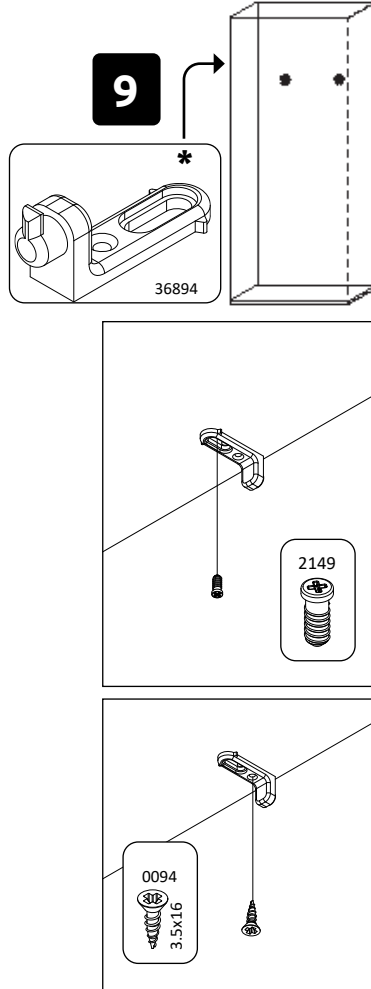

10

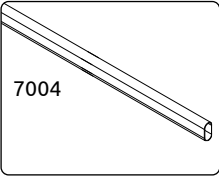

7004

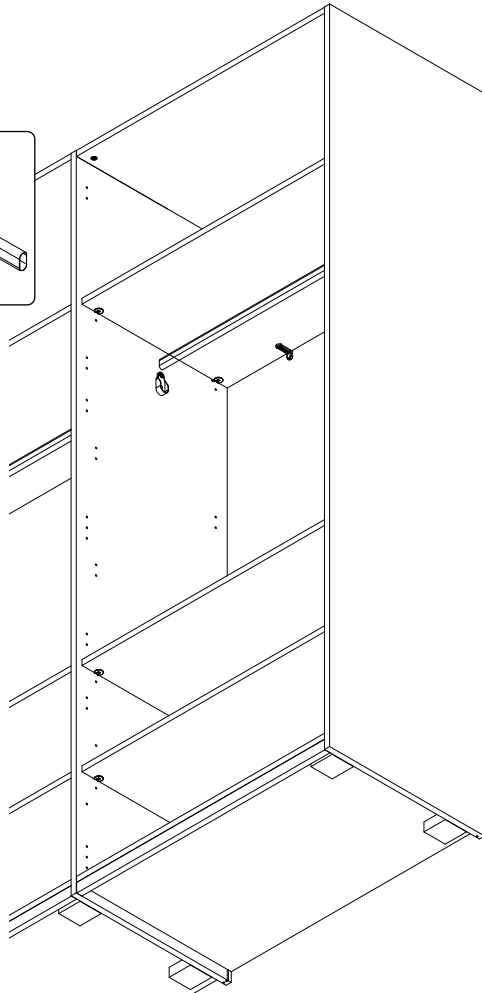

11

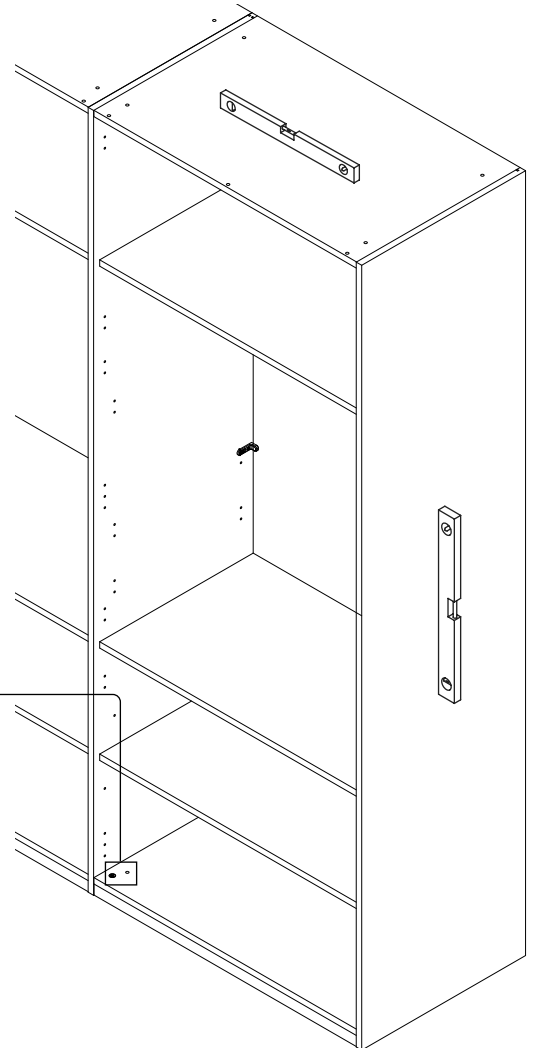
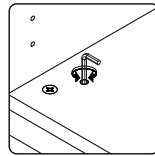
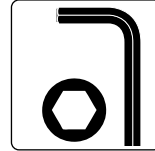
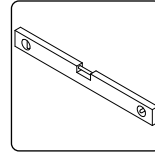

12

\*opt P+DP2

2149

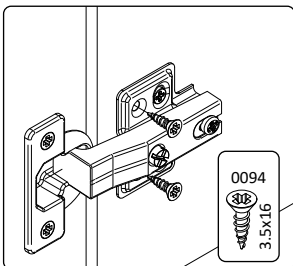
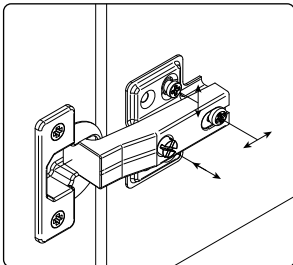
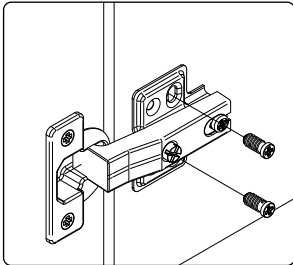

0094  
3.5x16

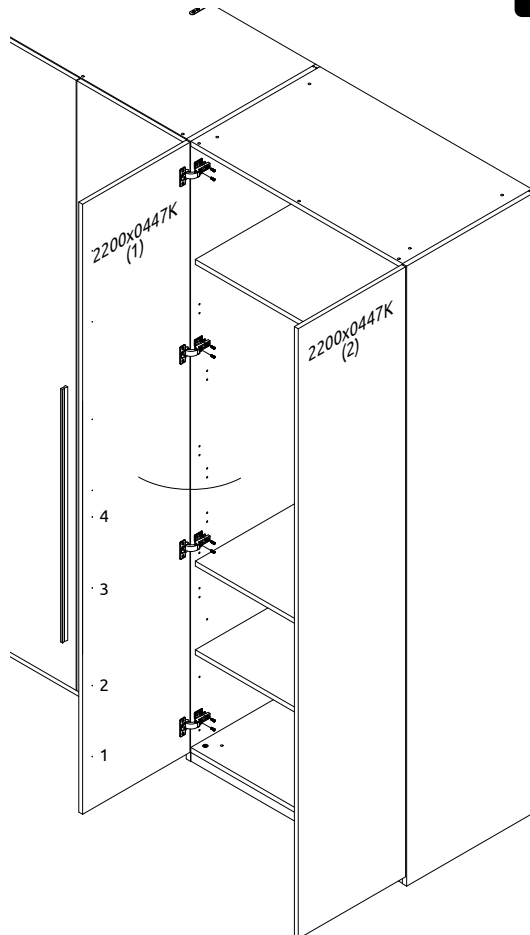

13

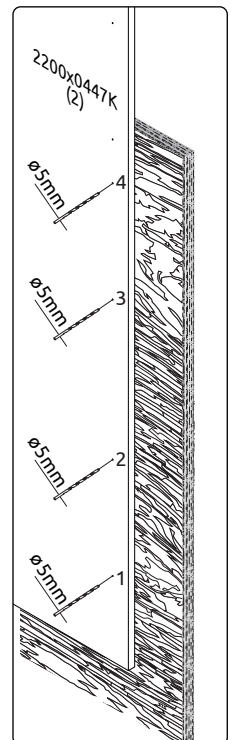
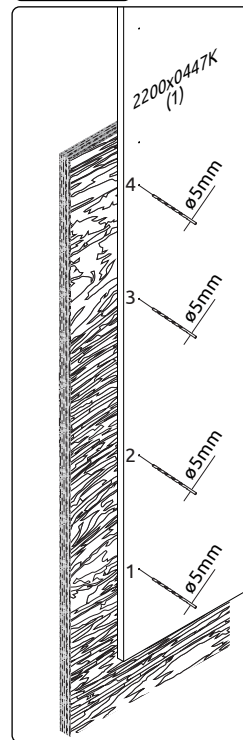
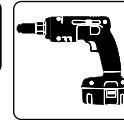

14

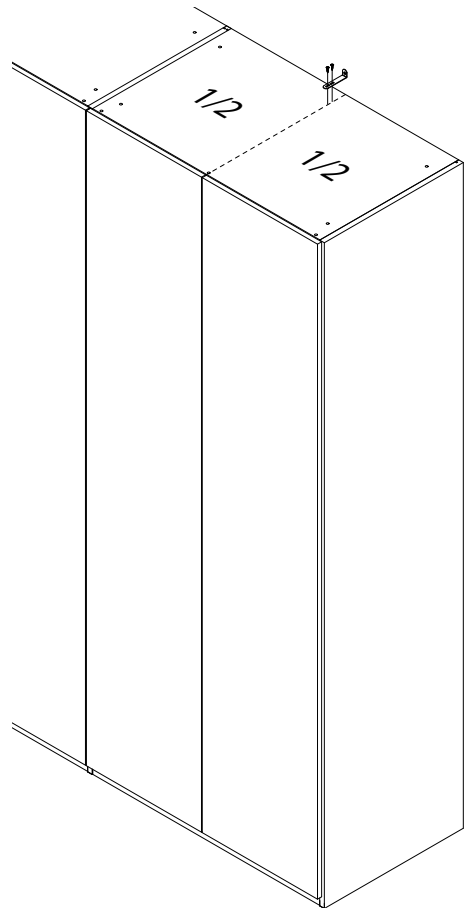
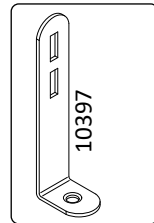
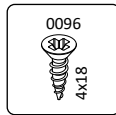
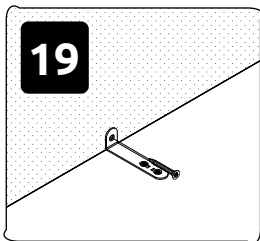
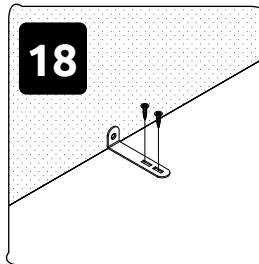
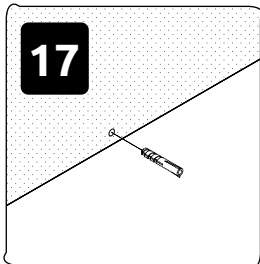
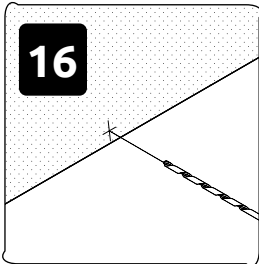
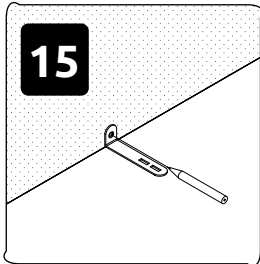
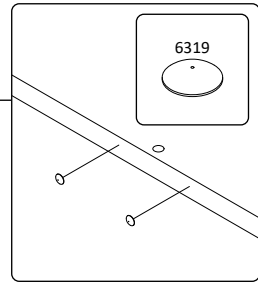
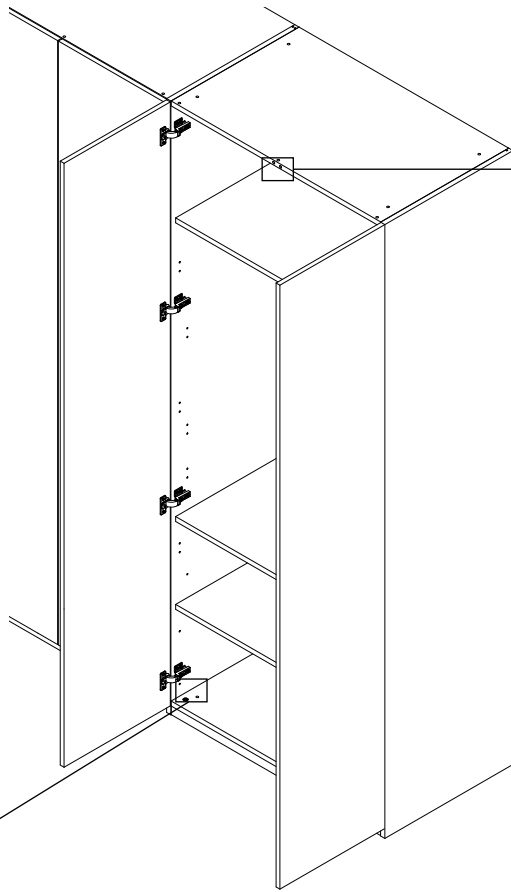
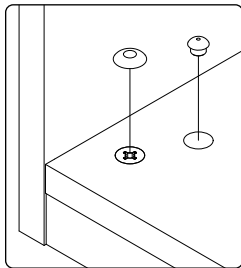
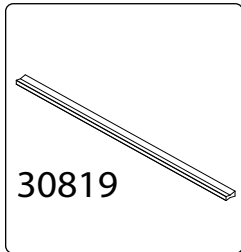



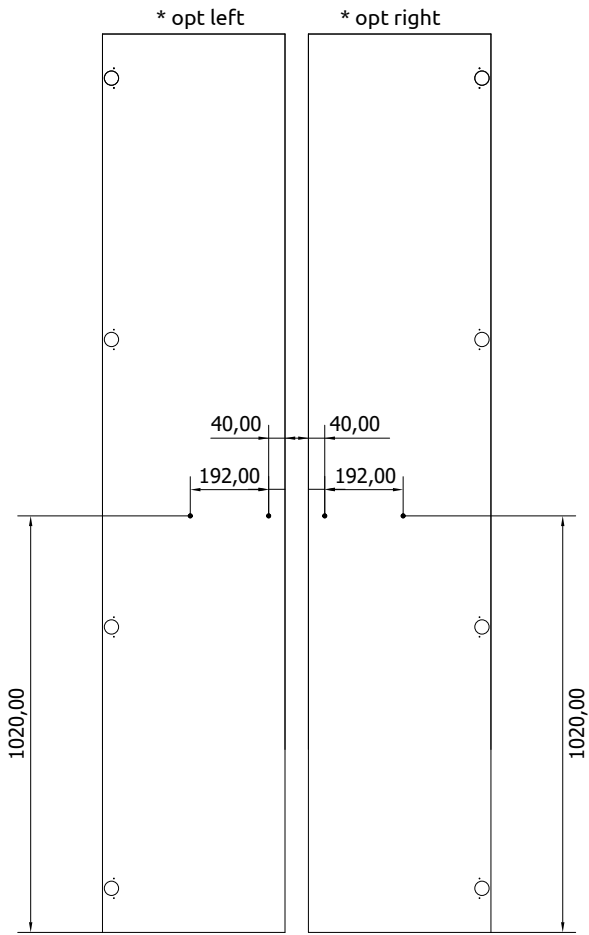

**\* OPT**

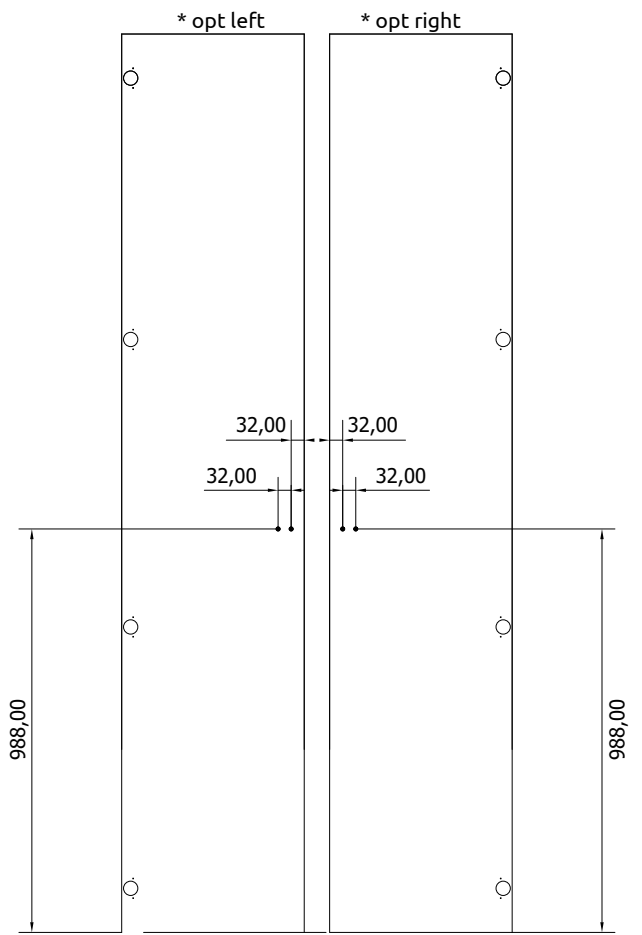
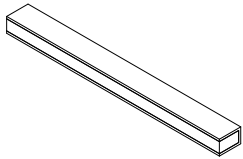

**\* OPT**

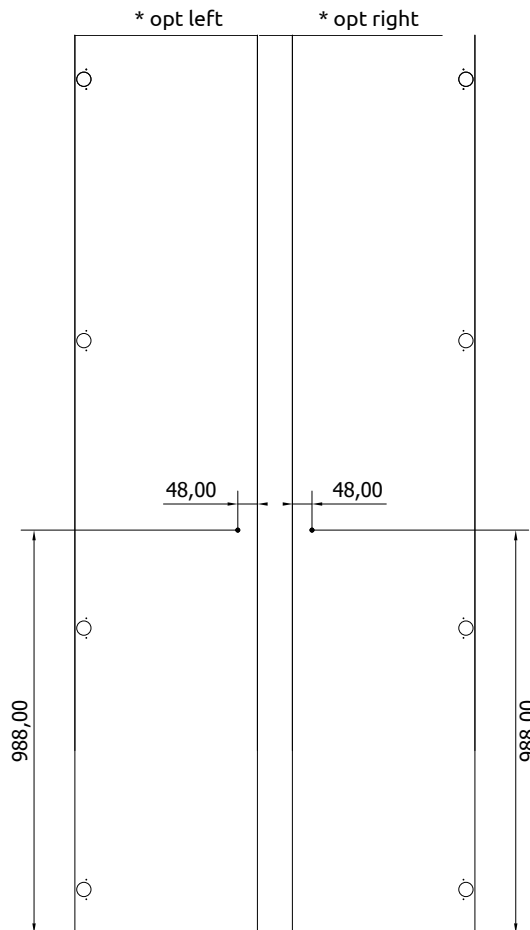
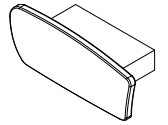

**\* OPT**

