

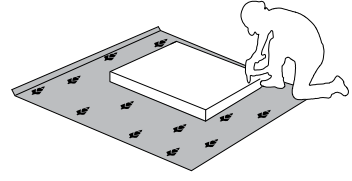

IMPORTANT - READ CAREFULLY - RETAIN FOR FUTURE REFERENCE  
WICHTIG - SORGFÄLTIG LESEN UND AUFBEWAHREN

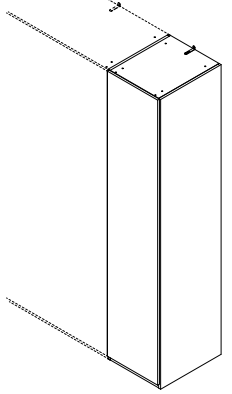

**DP1-AR**  
LWH - 450x555x2236

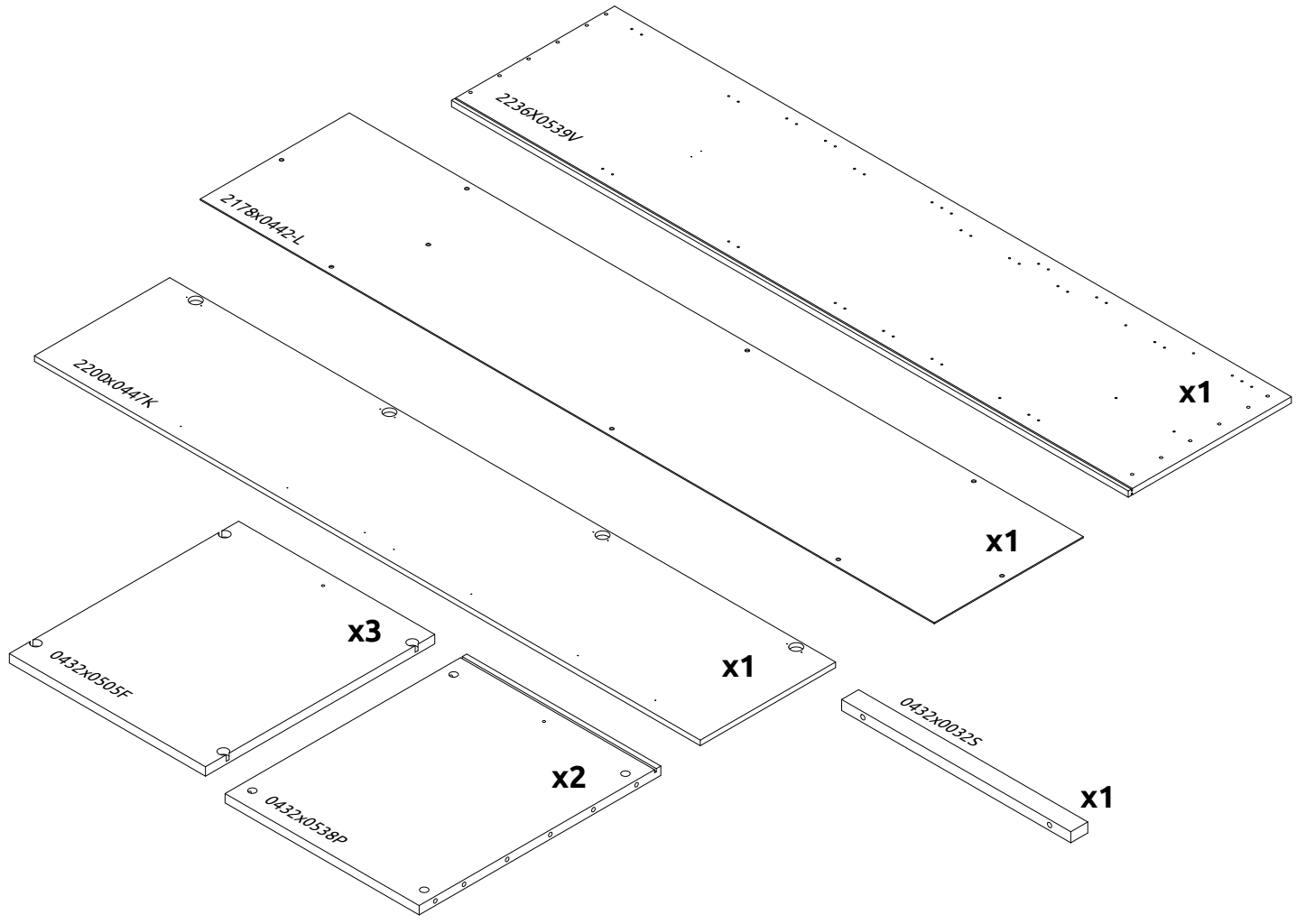
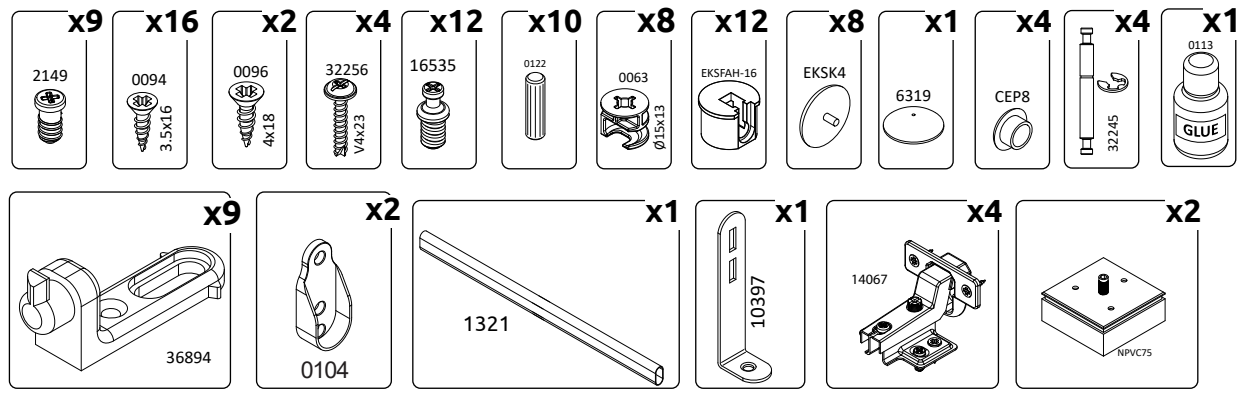
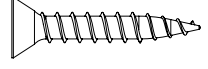

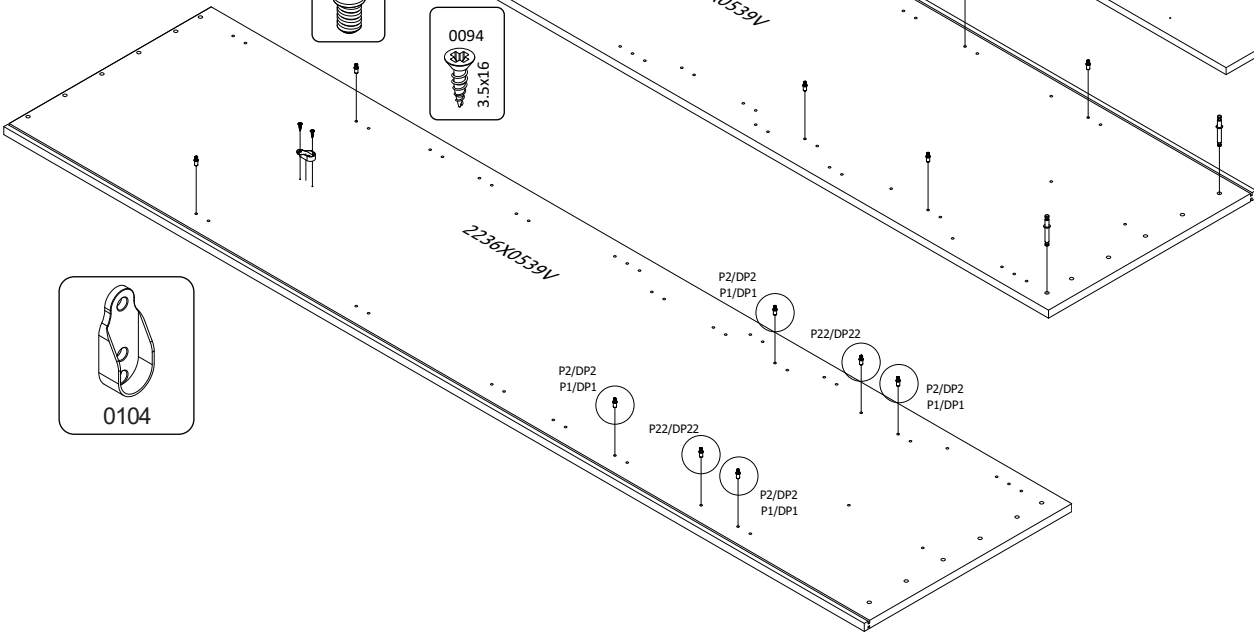
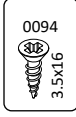
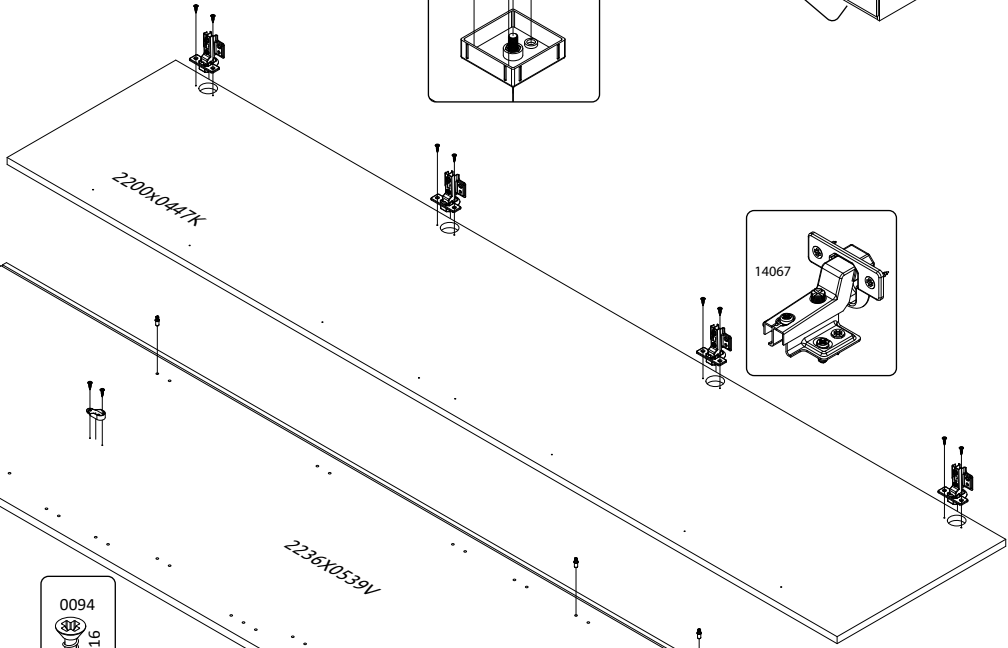
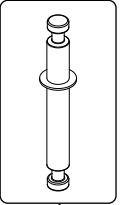
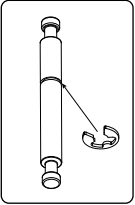
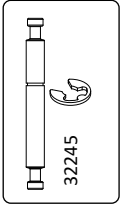
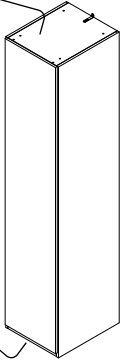
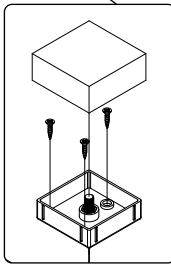
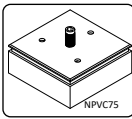
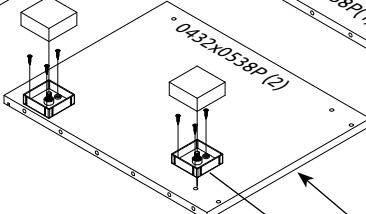
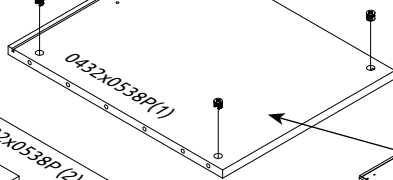
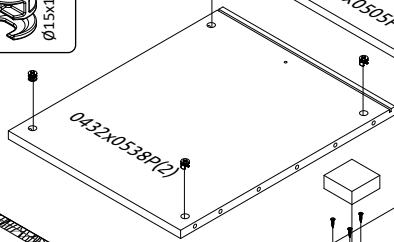
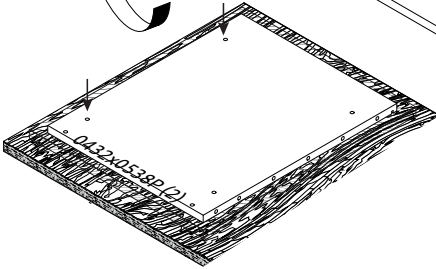
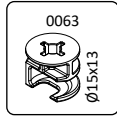

0104

P2/DP2  
P1/DP1

P22/DP22

P2/DP2  
P1/DP1

P22/DP22

P2/DP2  
P1/DP1

P2/DP2  
P1/DP1

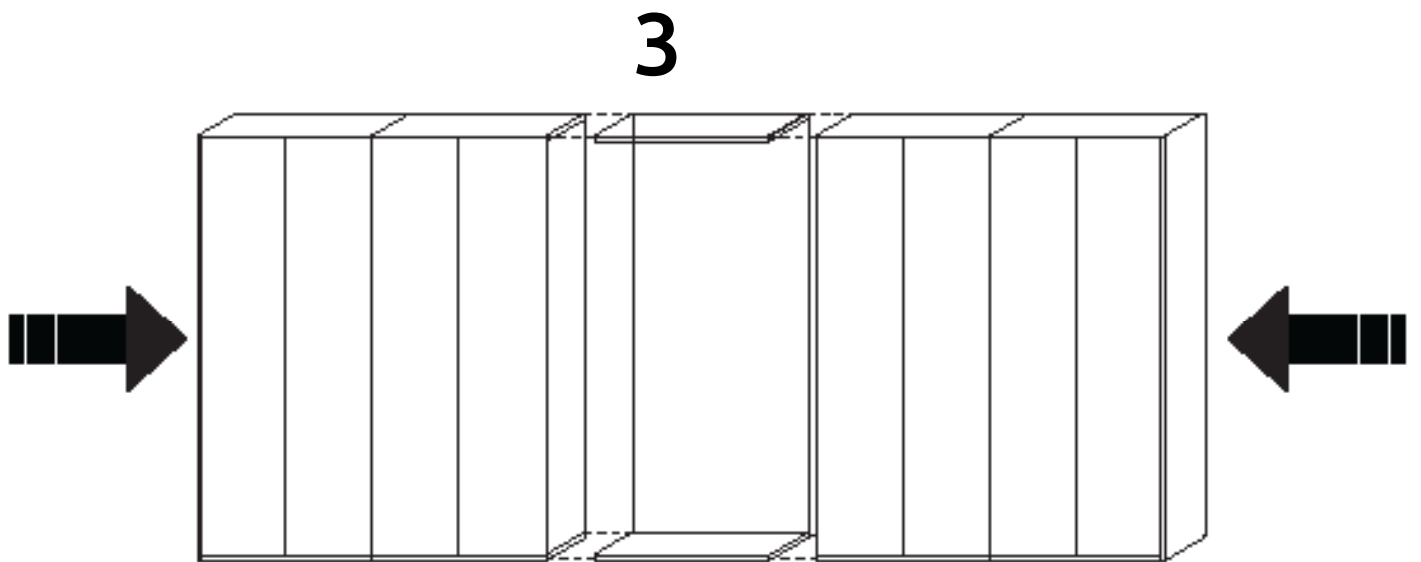
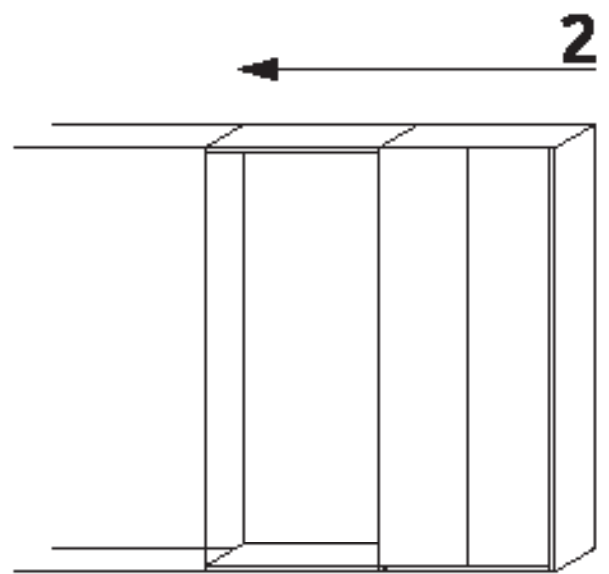
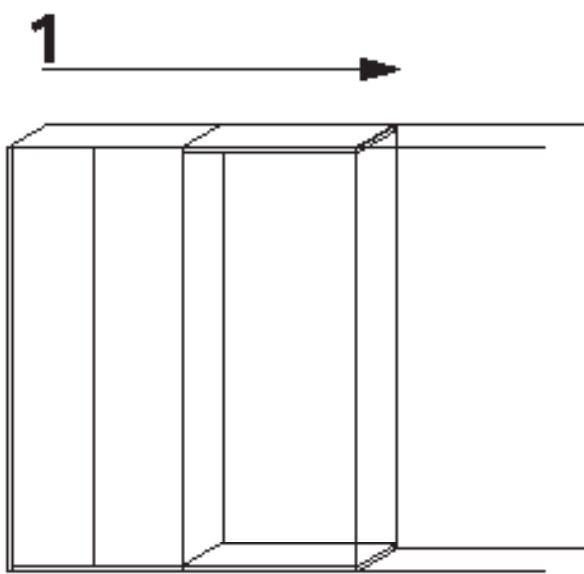
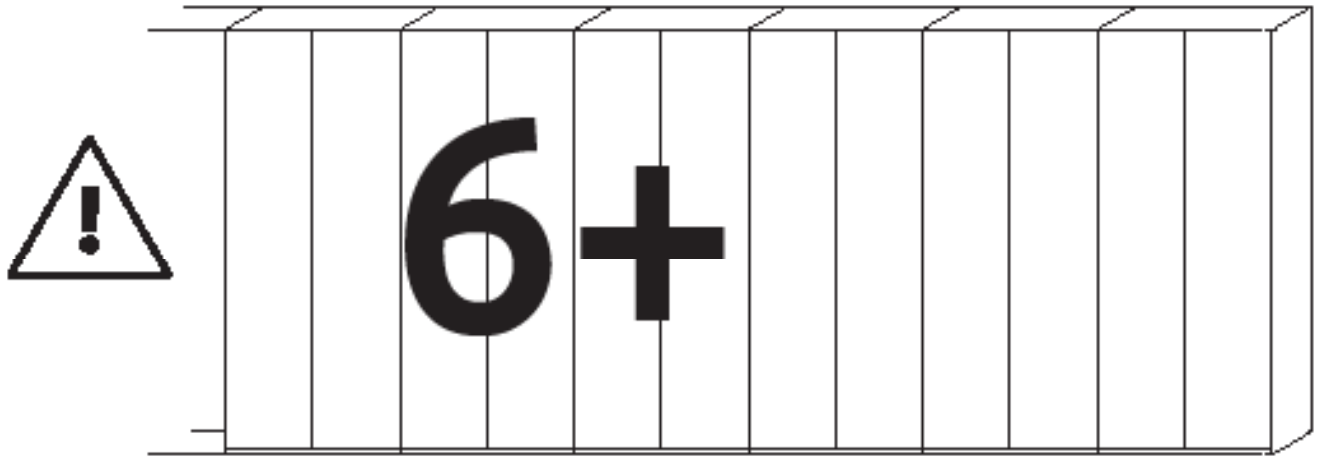

1

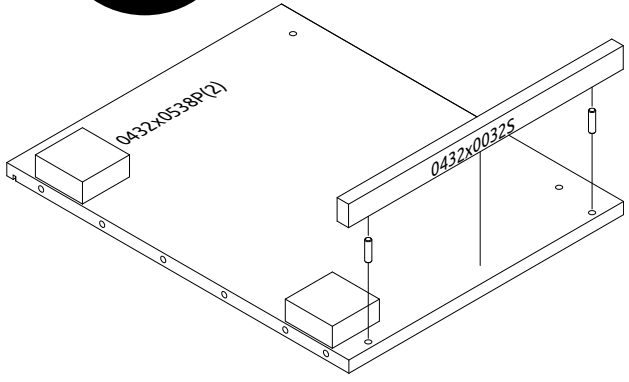
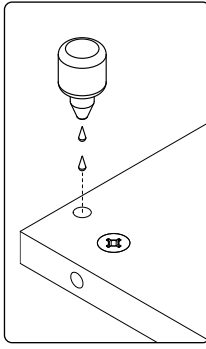
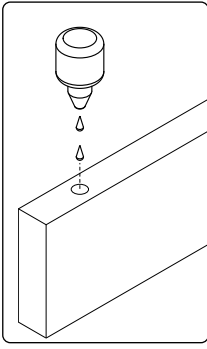
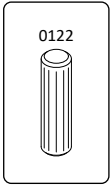

2

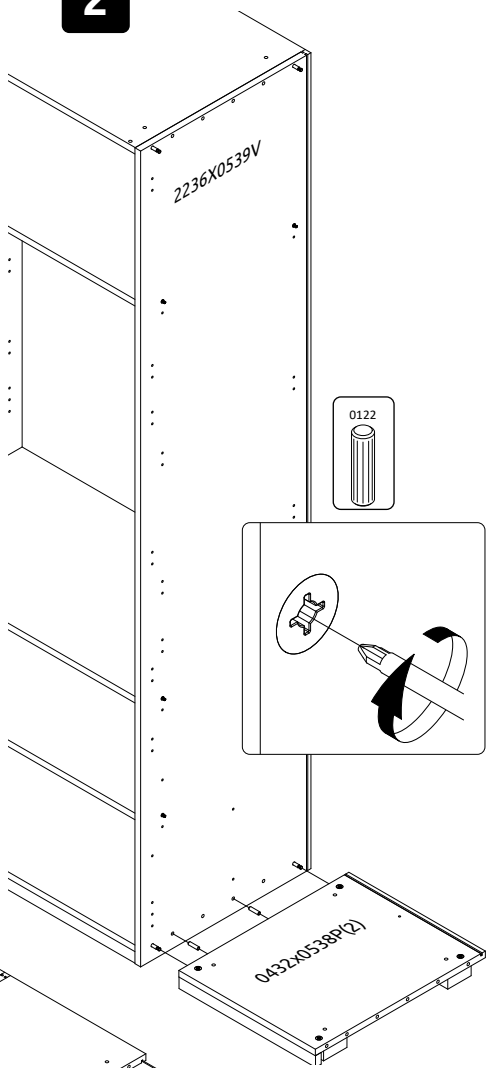

3

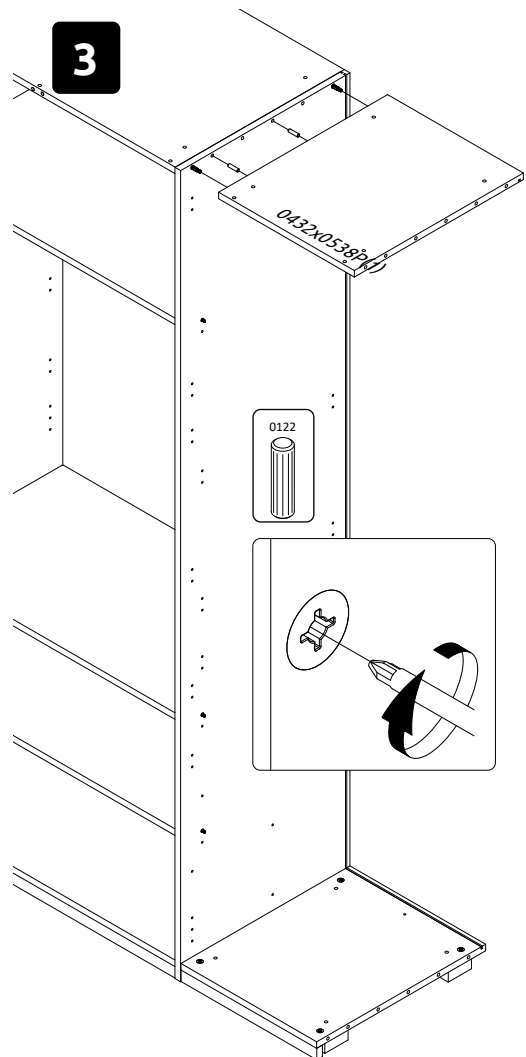

4

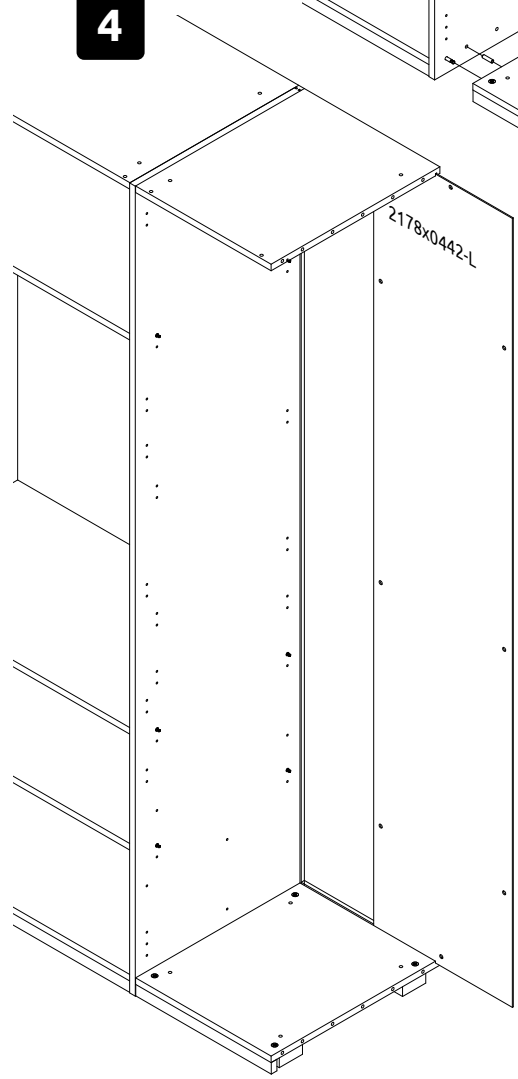

5



\*opt 1

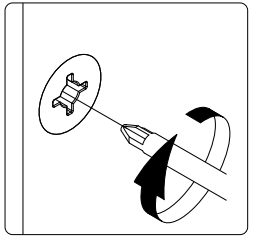
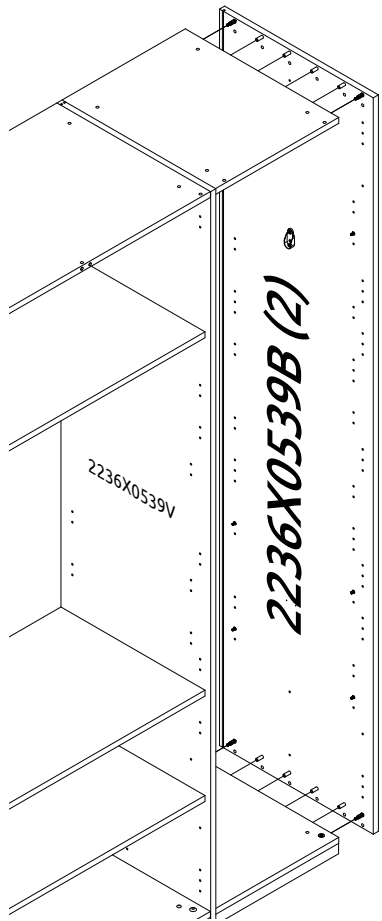
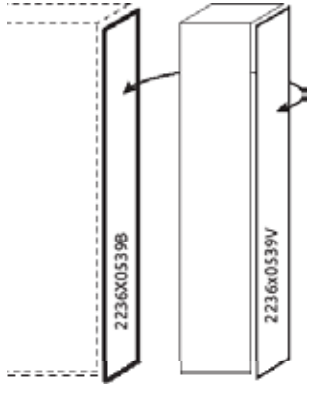

\*opt 2

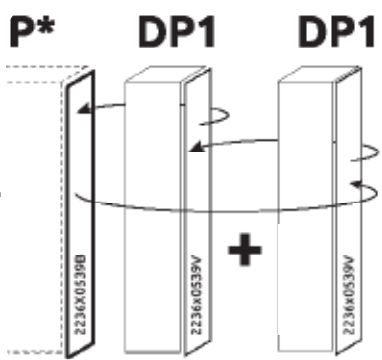

P\* = DP1 / DP2 / DP22

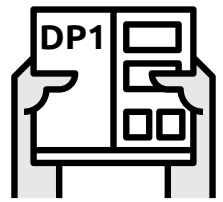

\*opt 3

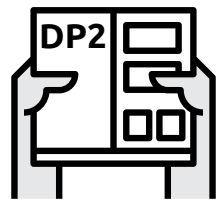
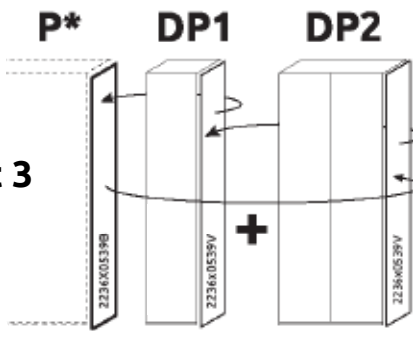

\*opt 4

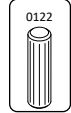
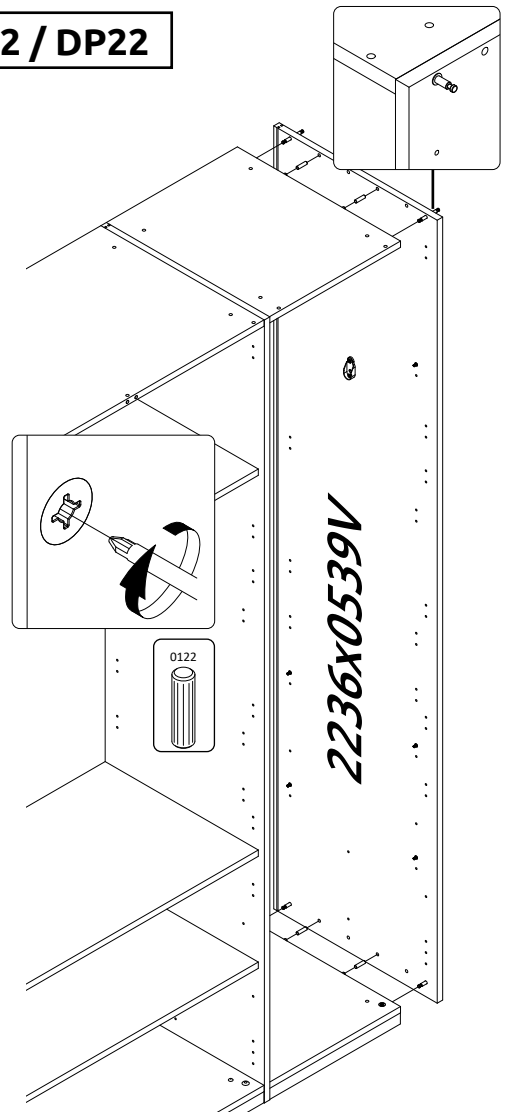
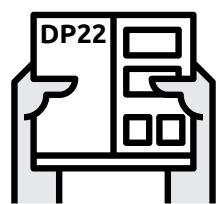
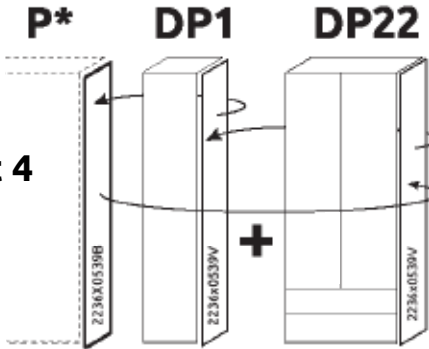

6

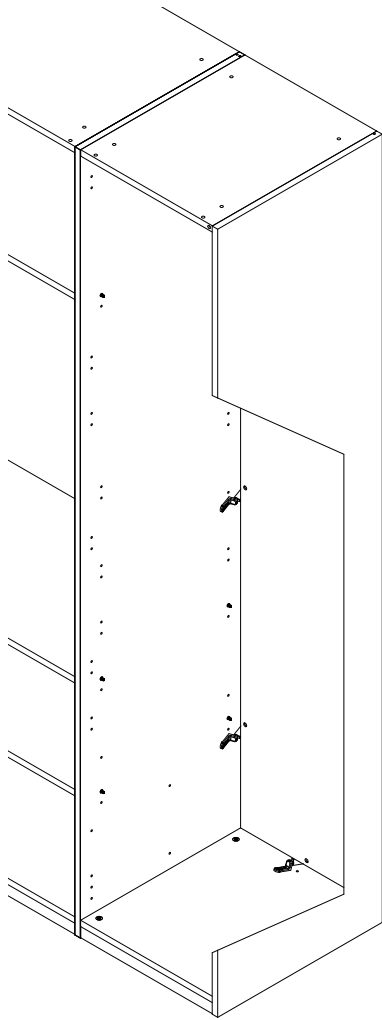
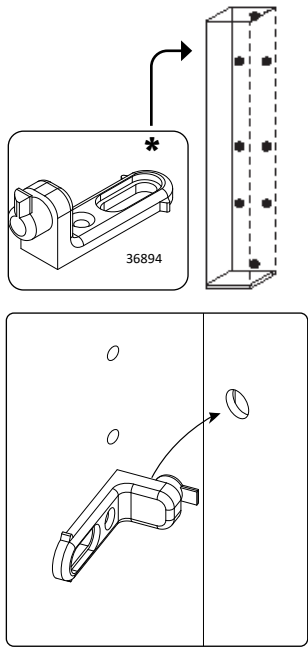

7

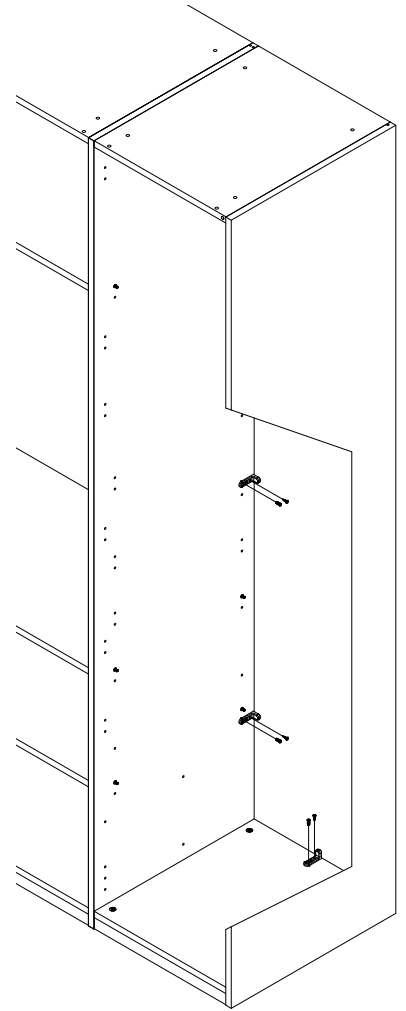
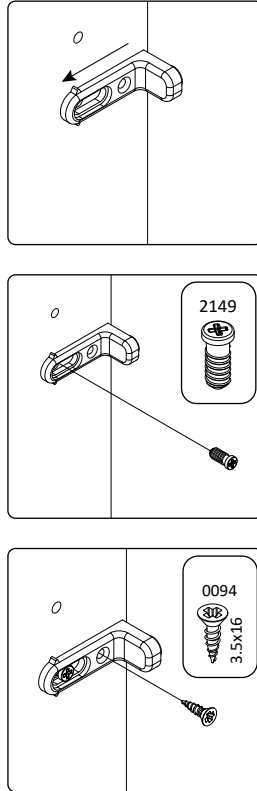

8

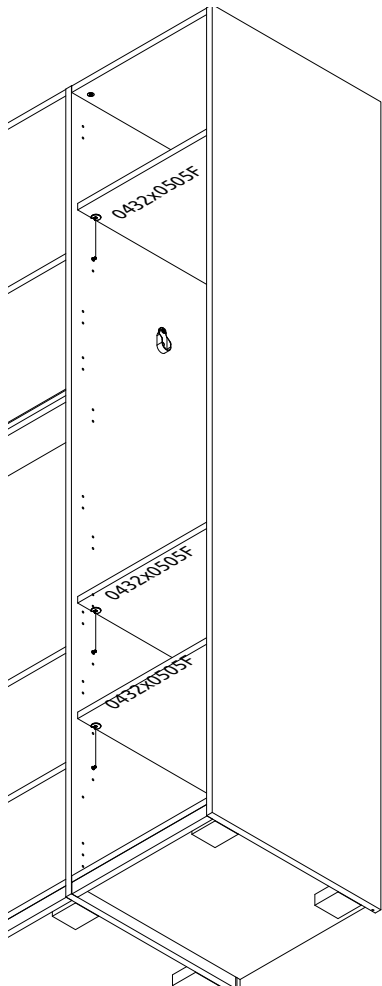

9

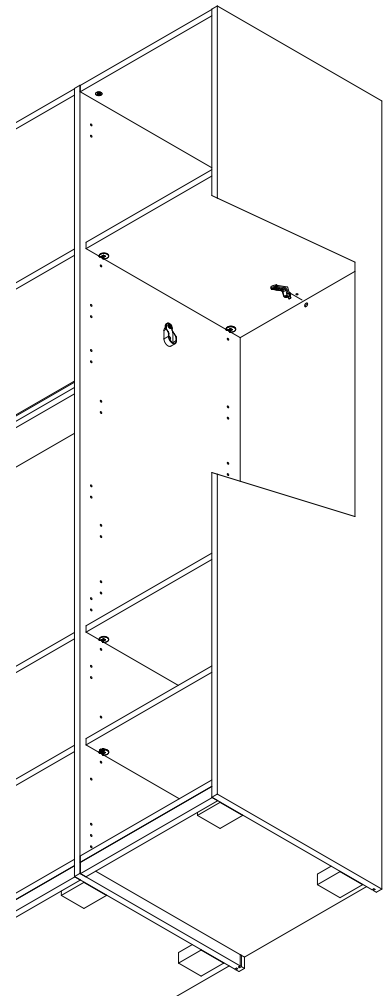
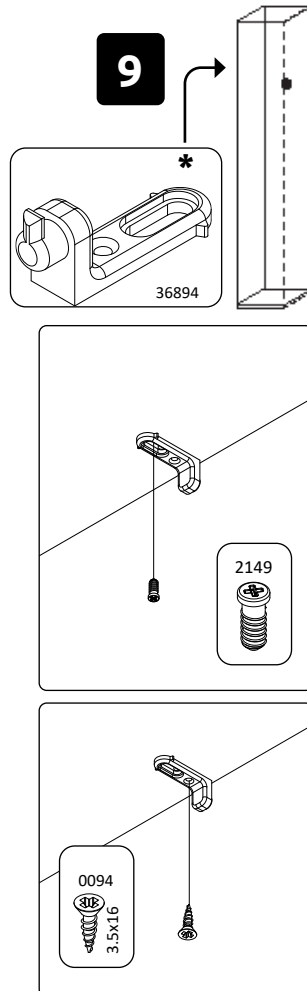

10

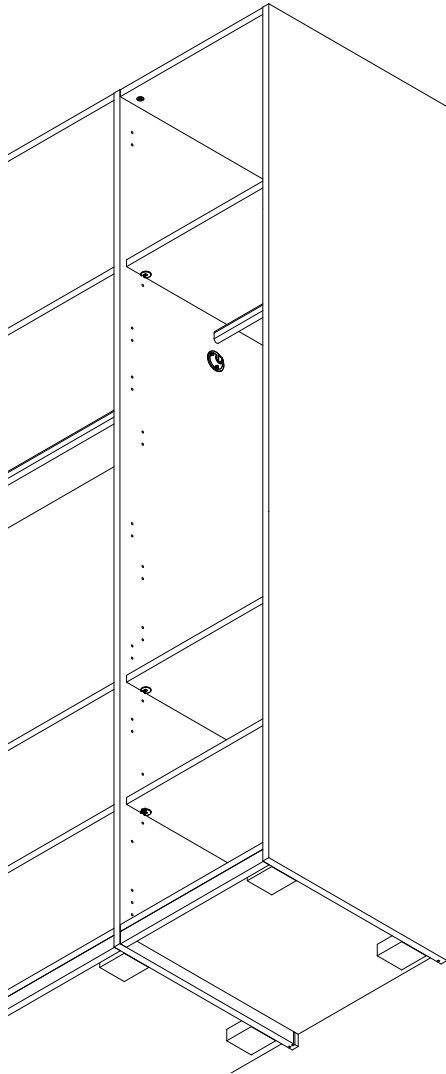

11

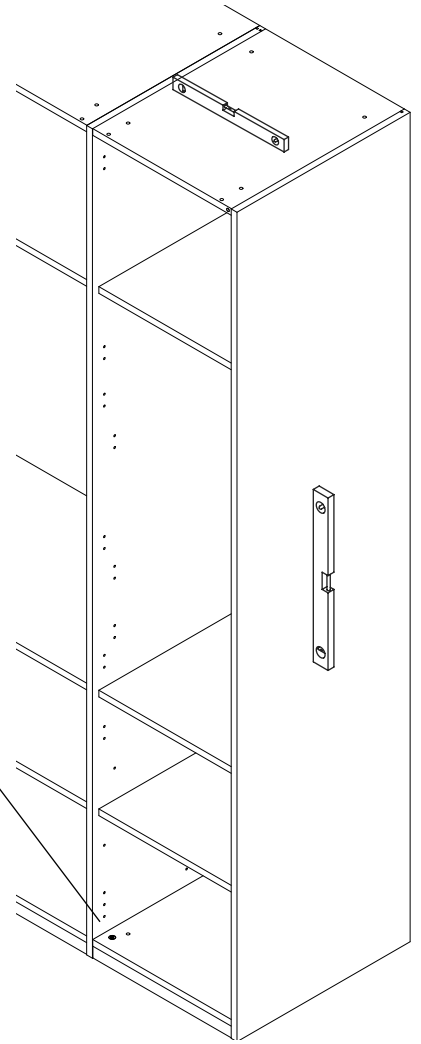
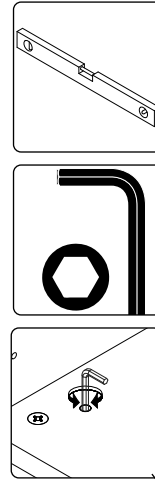

12

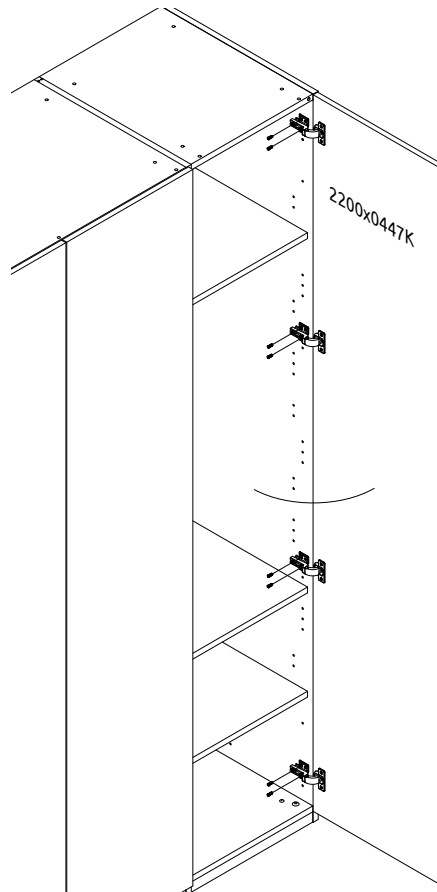
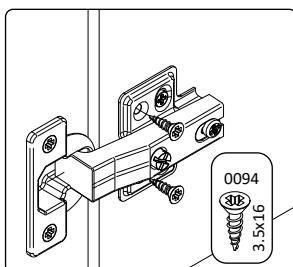
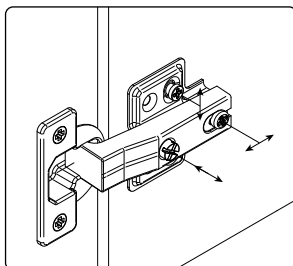
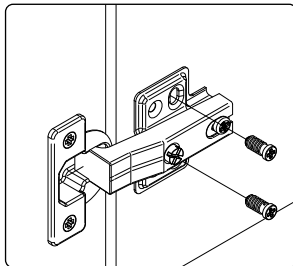

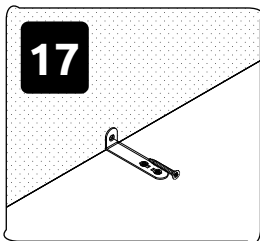
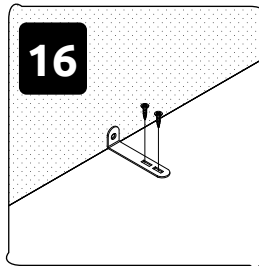
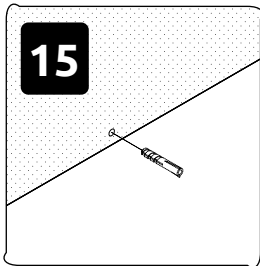
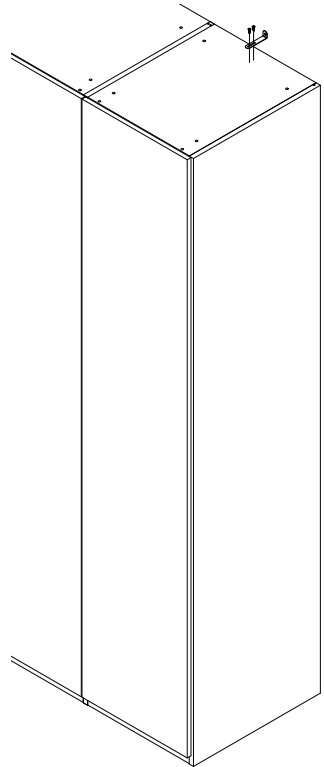
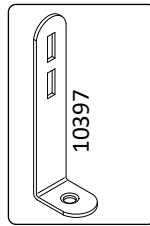
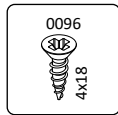
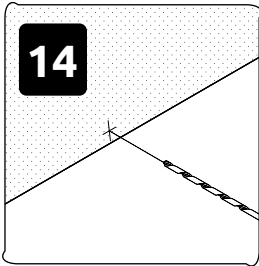
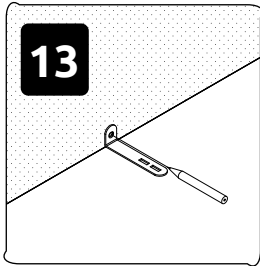
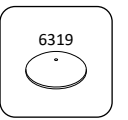
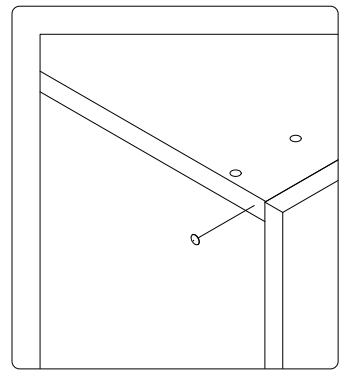
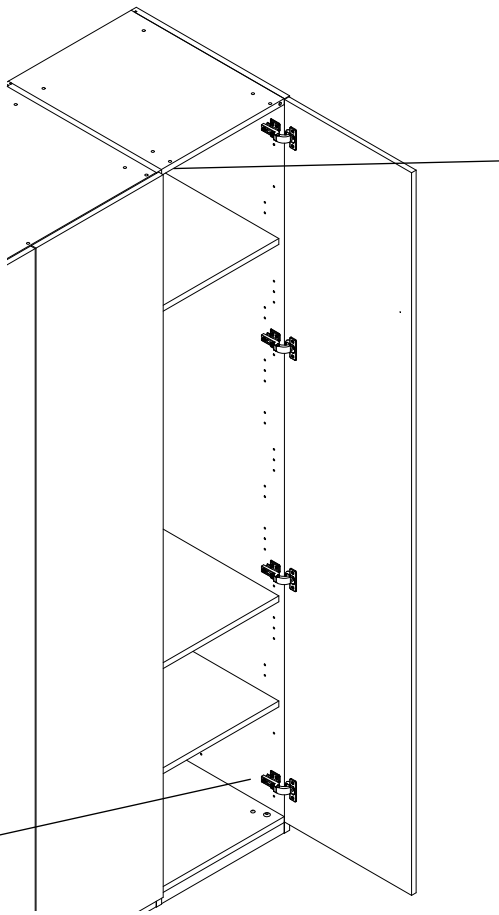
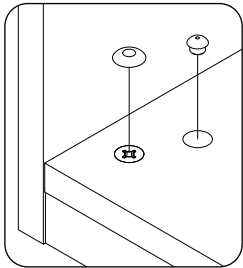
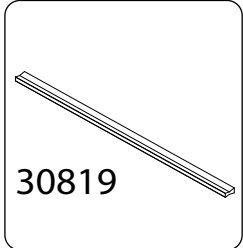
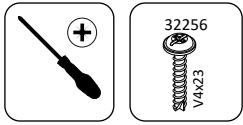



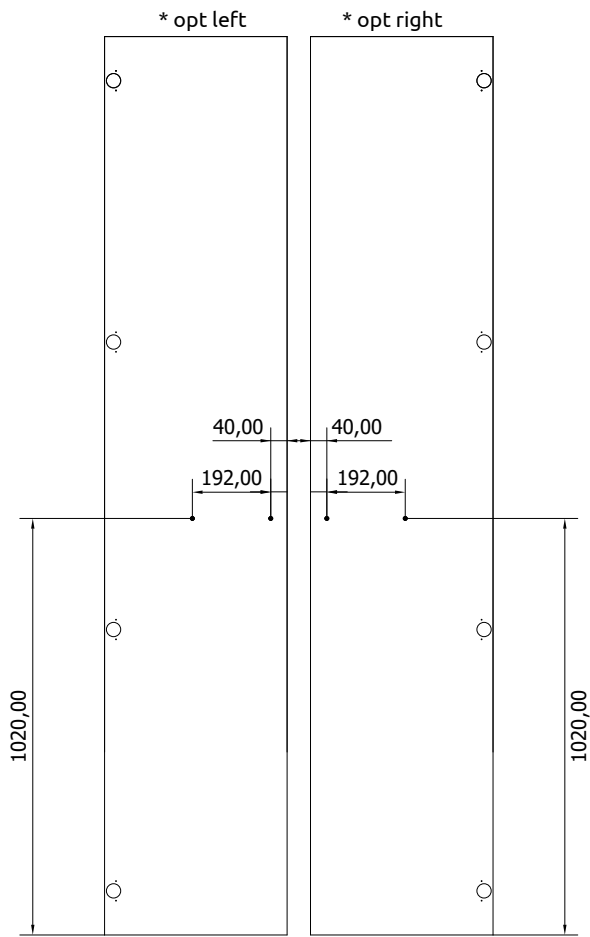

**\* OPT**

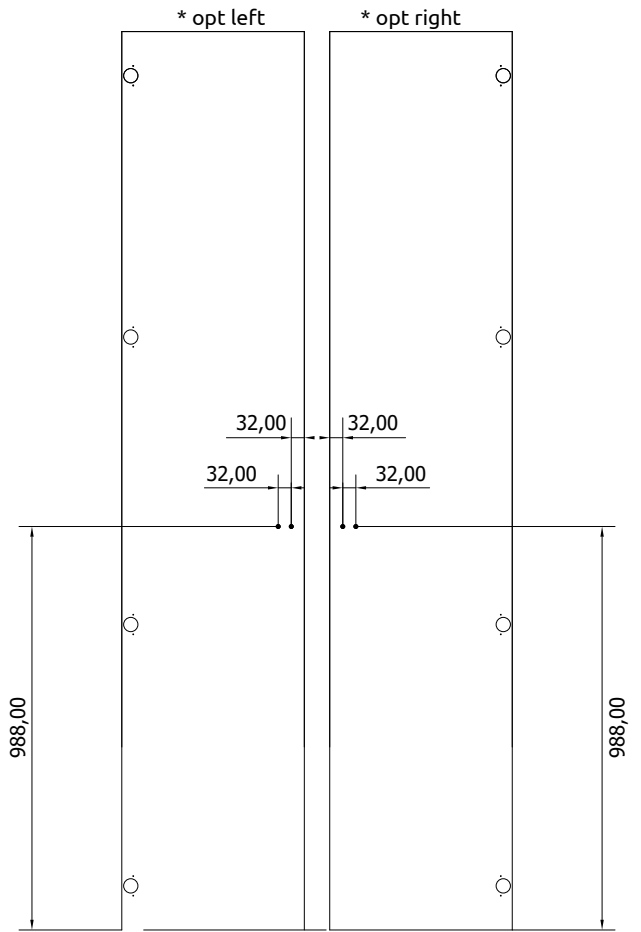
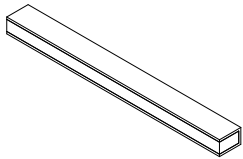

**\* OPT**

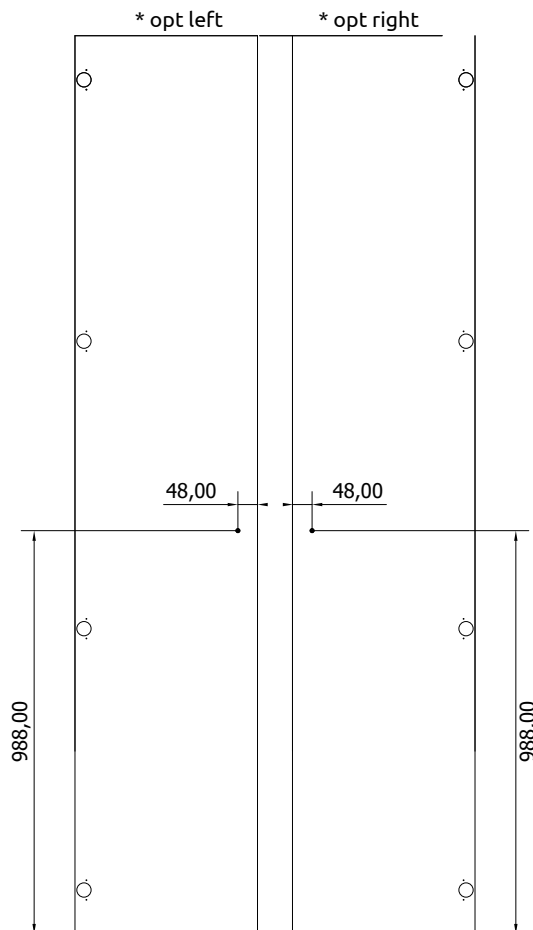
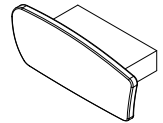

**\* OPT**

