

IMPORTANT – READ CAREFULLY – RETAIN FOR FUTURE REFERENCE  
WICHTIG - SORGFÄLTIG LESEN UND AUFBEWAHREN

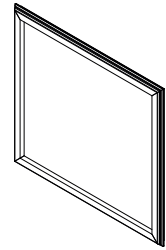

LHW - 988x817x41

**OG-EG**

20. 10. 2020

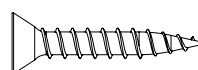
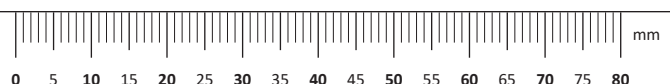
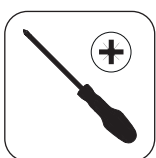
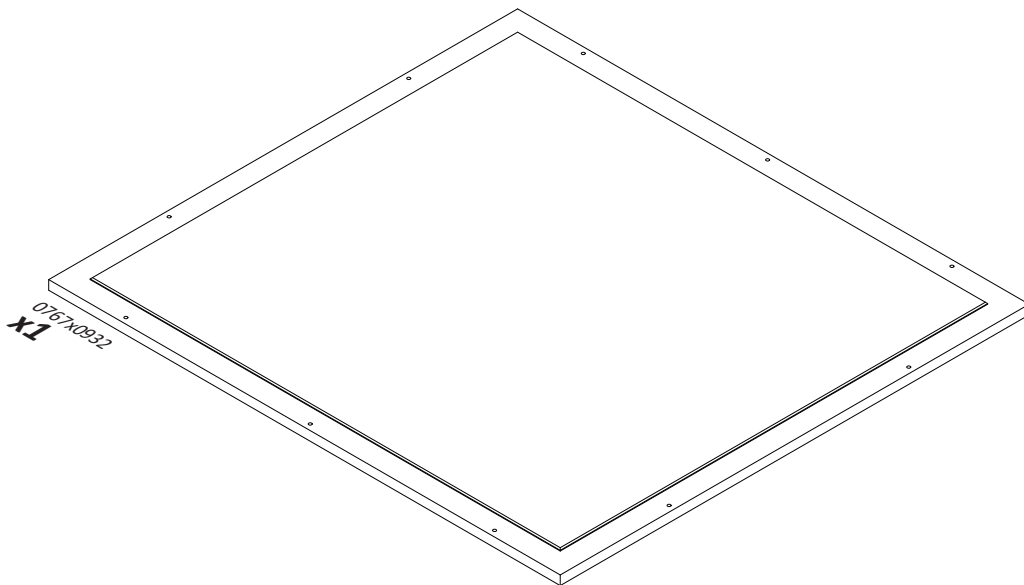
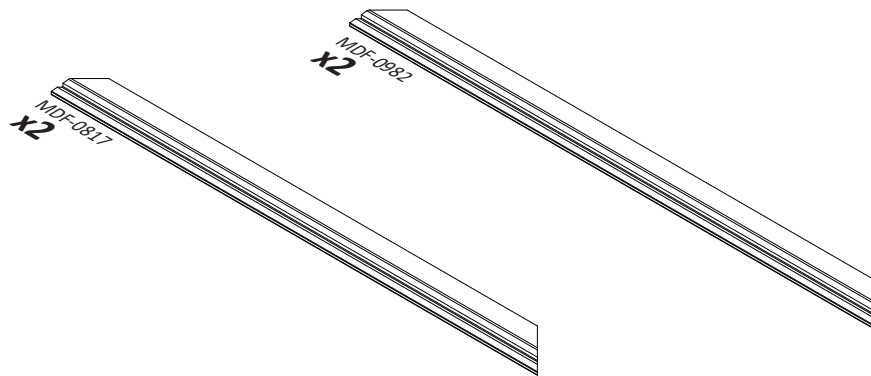
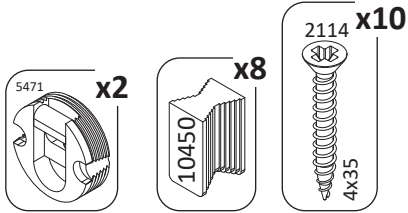

assembly@jela.rs

1

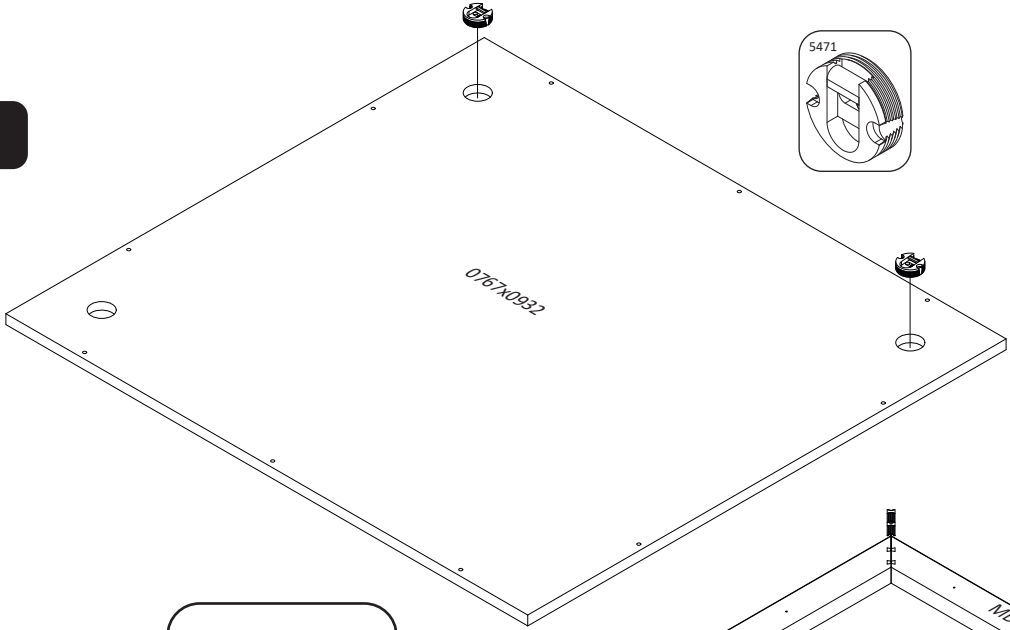

2

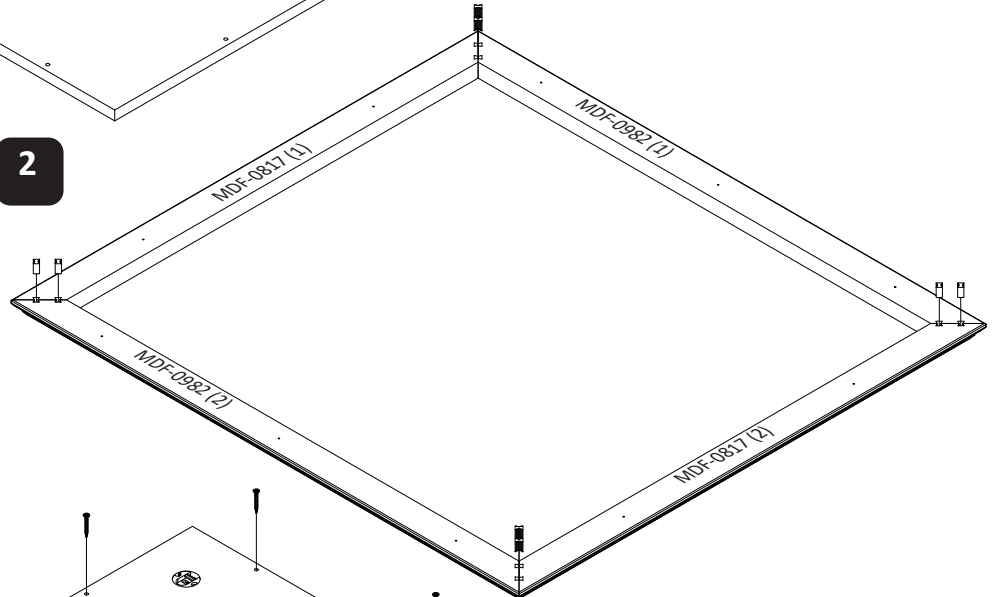
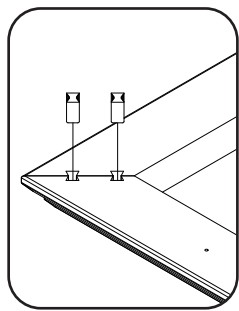
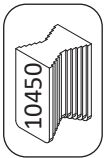

3

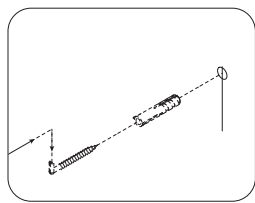
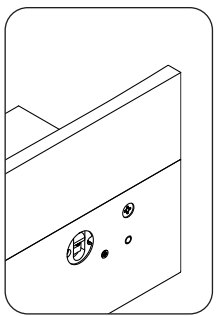
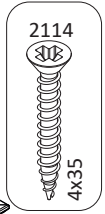
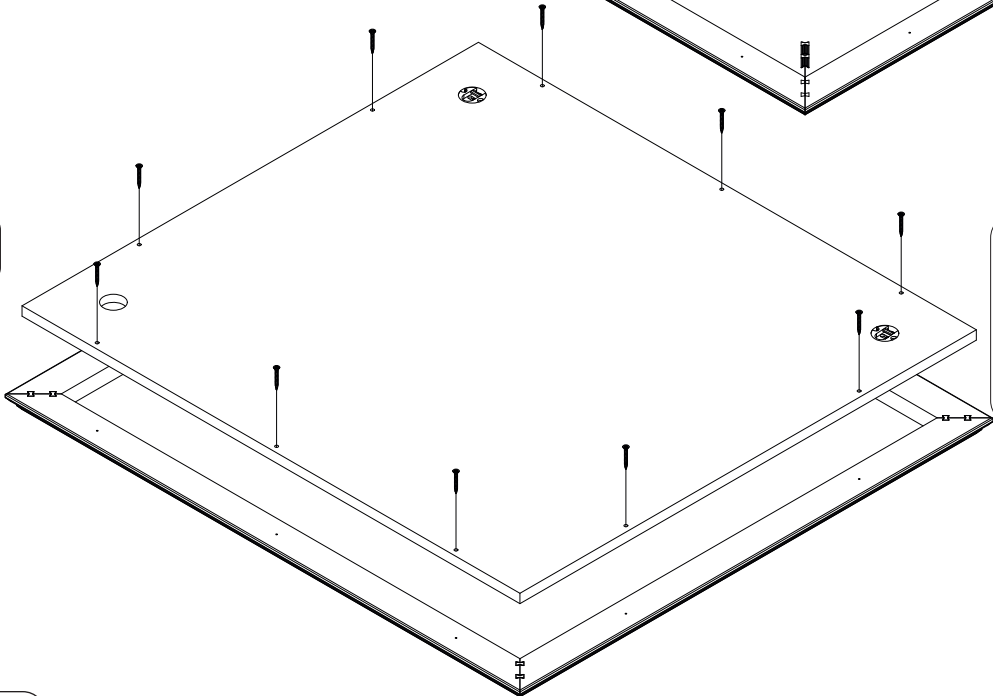

**ENGLISH**  
Important information  
Read carefully.  
Keep this information for further reference.

**WARNING!**  
Fixing devices for the wall are not included since different wall materials require different types of fixing devices. Use fixing devices suitable for the walls in your home. For advice on suitable fixing systems, contact your local specialized dealer.

**DEUTSCH**  
**ACHTUNG HINWEIS!**  
Wichtige Information - Bitte sorgfältig lesen und aufbewahren!

Beschläge für die Wandbefestigung sind nicht beige packt, da sie von der jeweiligen Wandbeschaffenheit abhängig sind. Benutzen Sie ausschließlich Befestigungsbeschläge, die für die heimischen Wände geeignet sind. Bei diesbezüglichen Fragen ziehen Sie den örtlichen Fachhandel zu Rate.