

20.76.1501.00

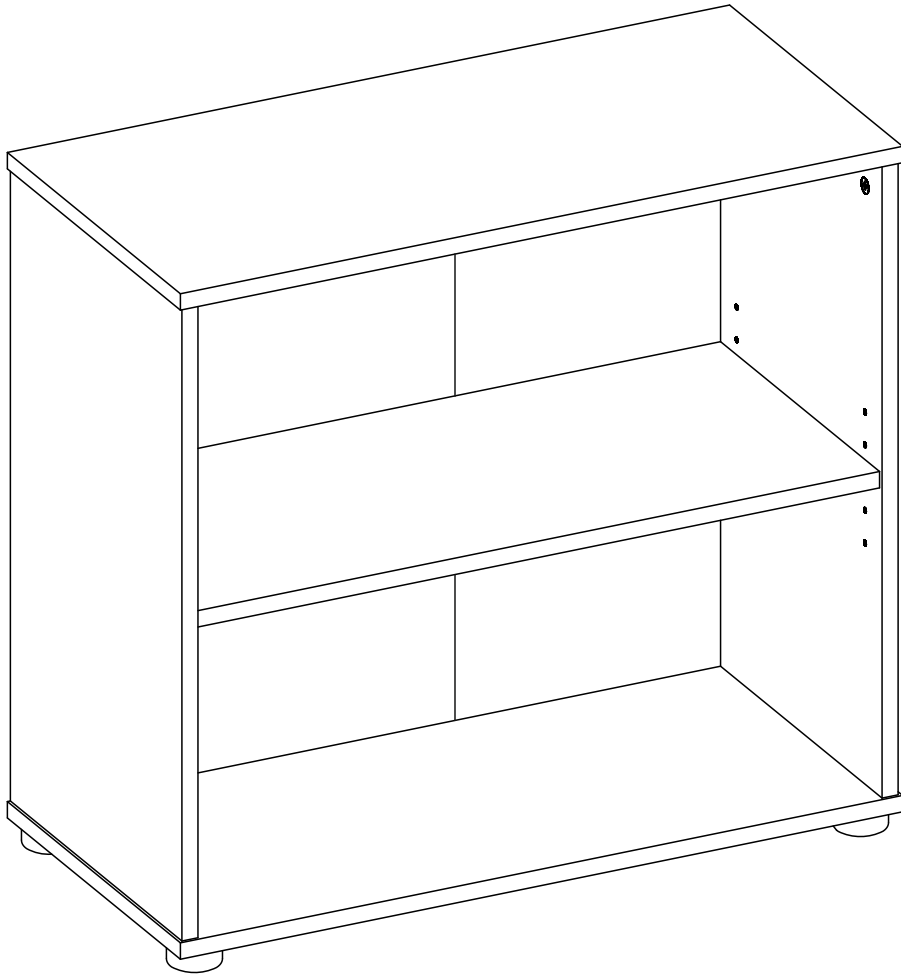

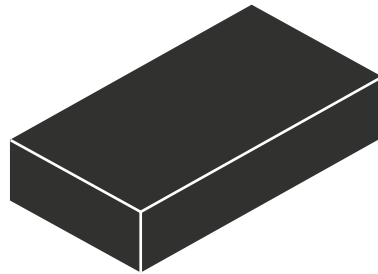

1 / 1

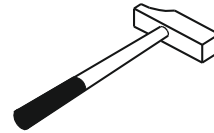
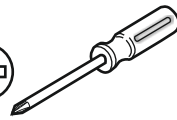
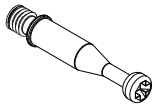

13.07.01.108 x 4



13.07.01.110 x 4



13.01.01.046 x 4

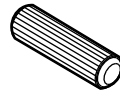

13.01.01.111 x 8



13.07.01.580 x 4



13.01.01.790 x 4

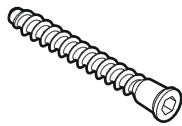

13.02.01.019 x 4



13.01.01.178 x 4



13.01.01.170 x 4

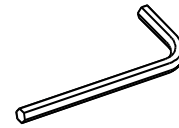

13.07.01.016 x 1

1 / 1

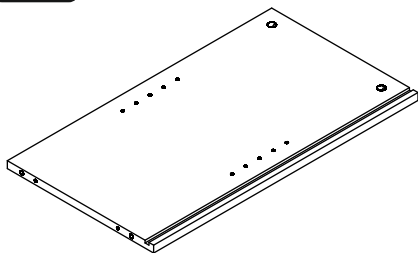

18.76.1501.001 x 1

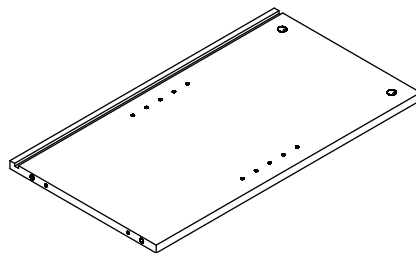

18.76.1501.002 x 1

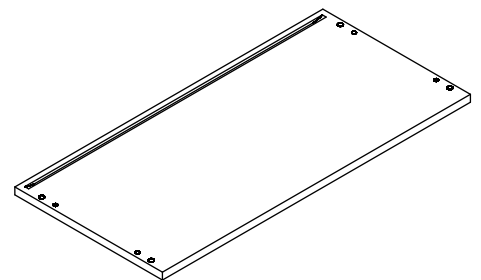

18.76.1501.003 x 1

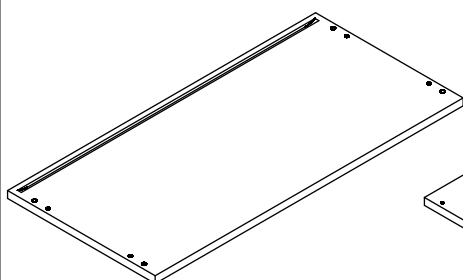

18.76.1501.004 x 1

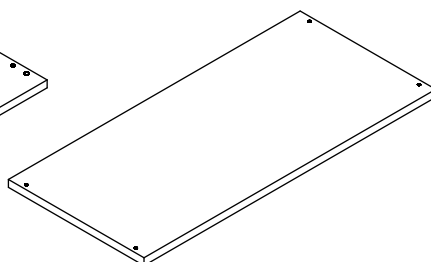

18.76.1501.005 x 1

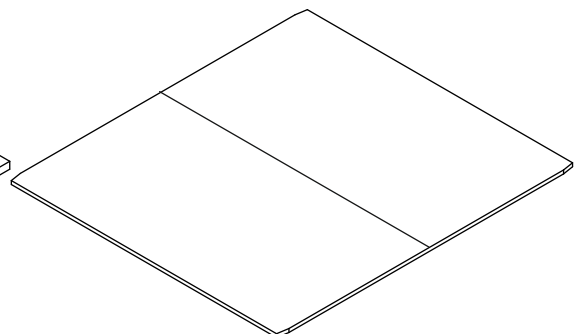

18.76.1501.007 x 1

1

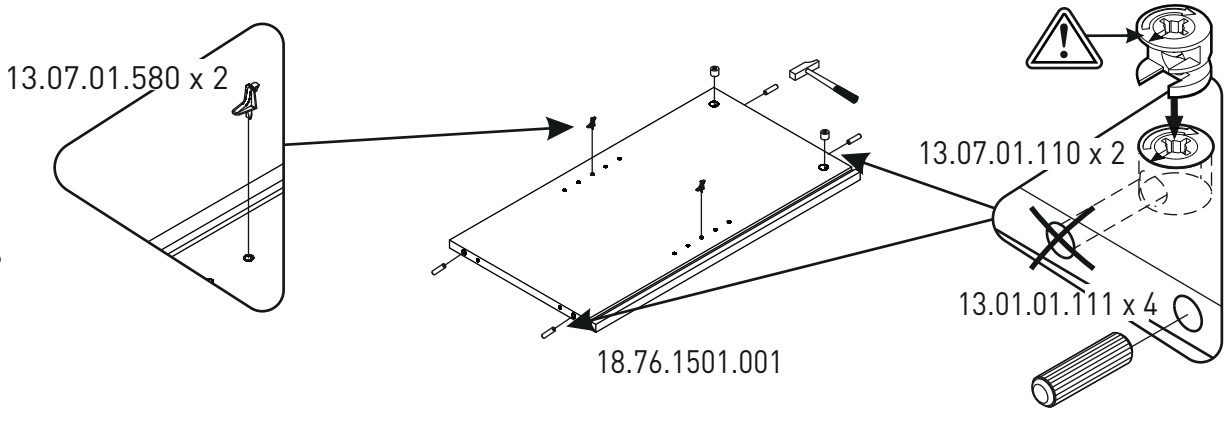

2

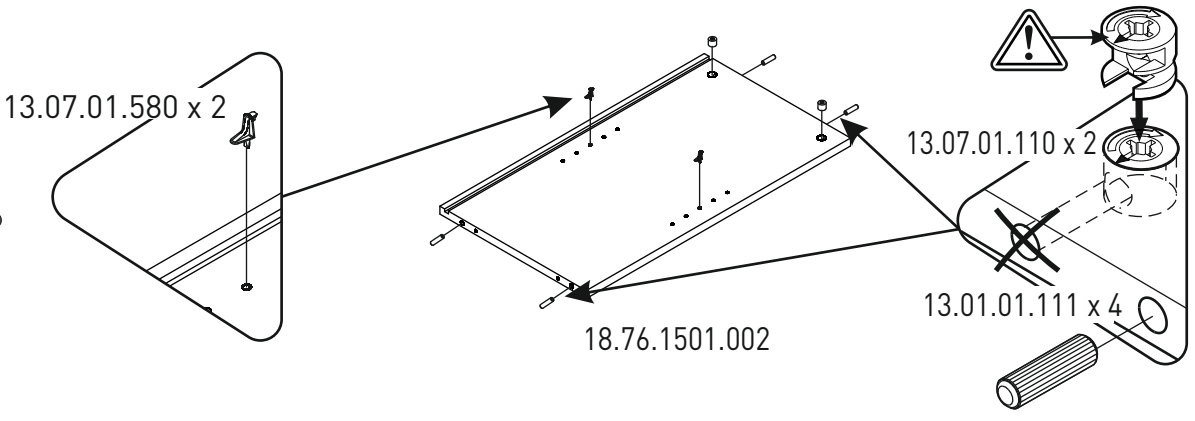

3

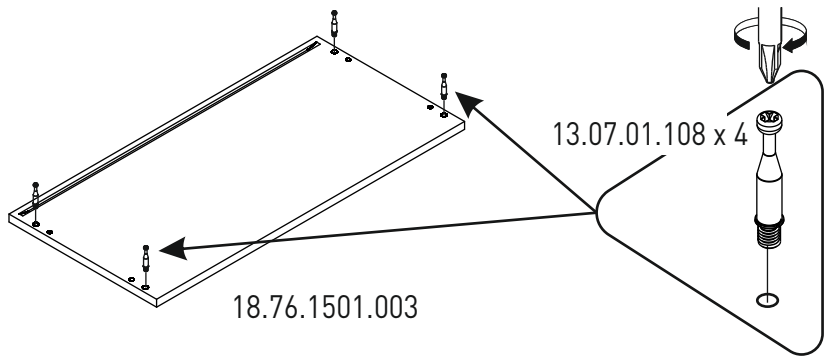

4

