

T.-Nr. 731.8251

Index : 7

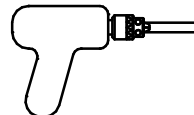

Ø10 mm

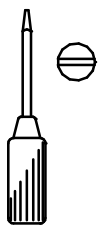
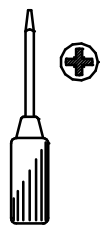
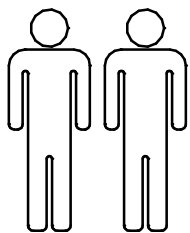
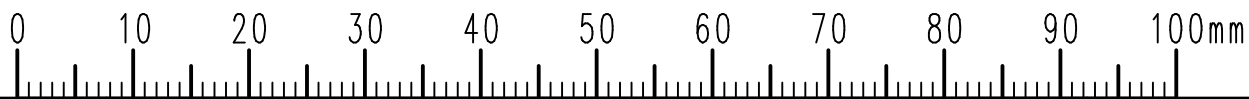
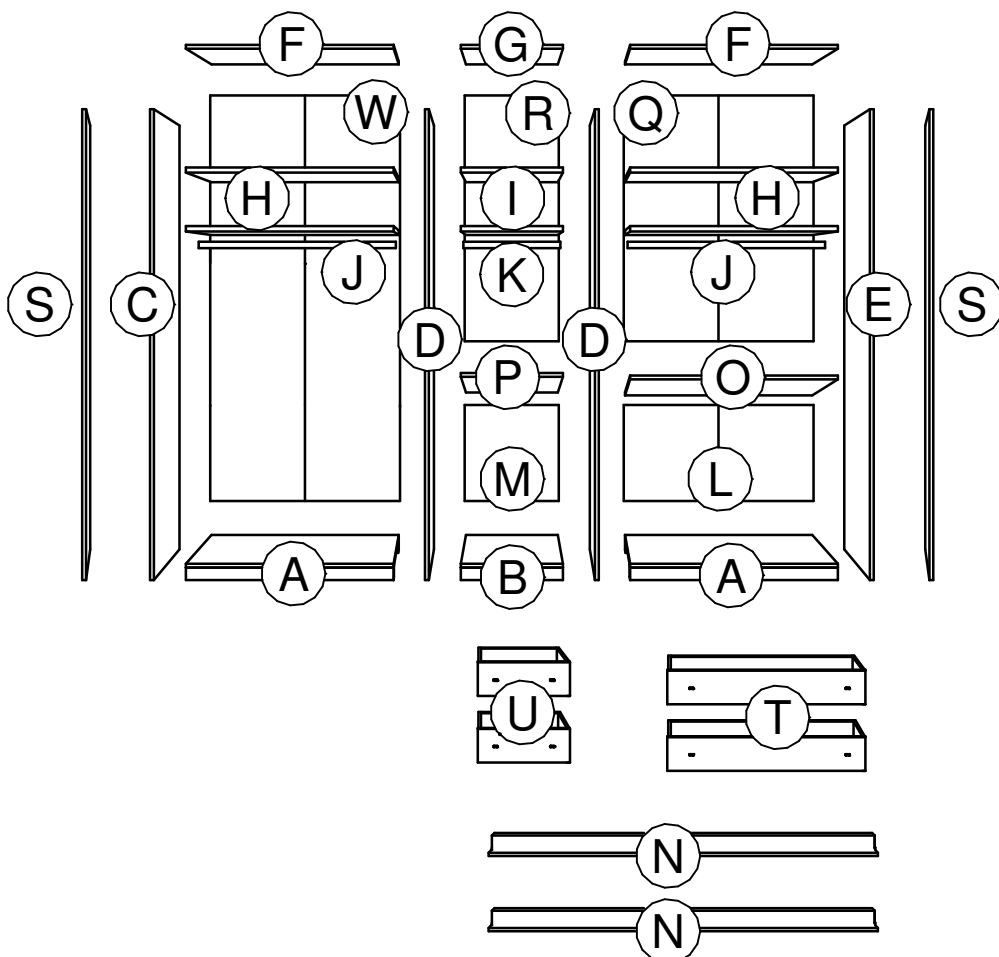
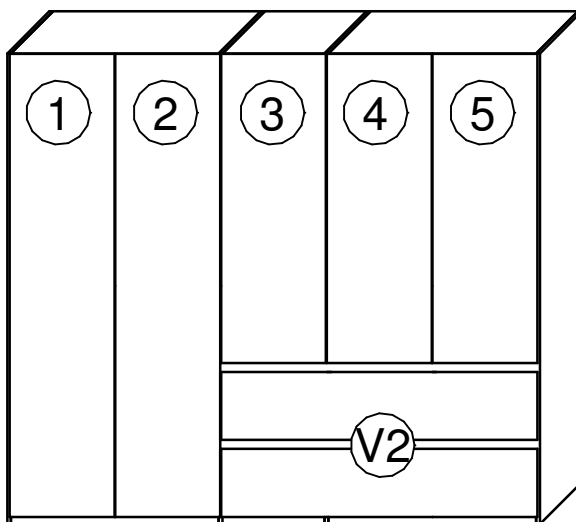

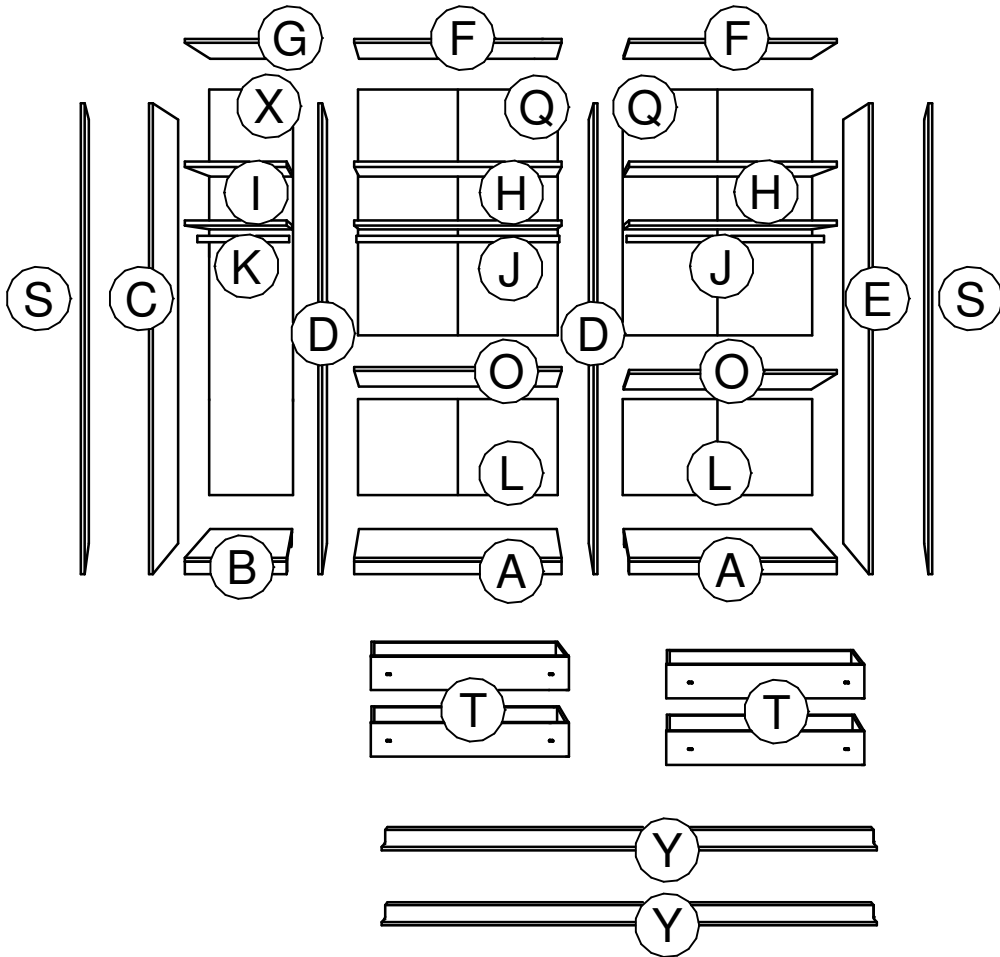
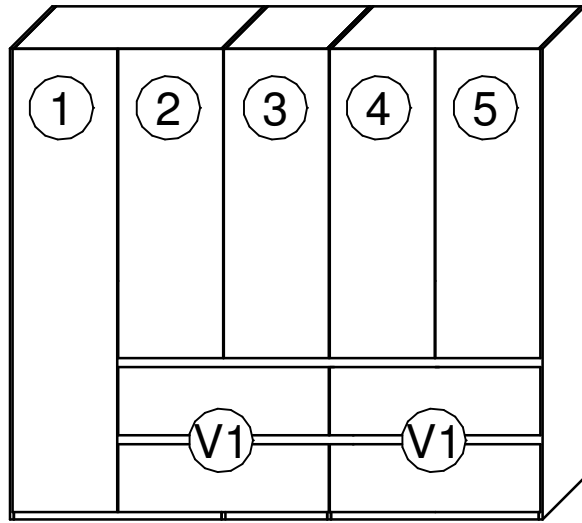

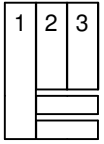

V1

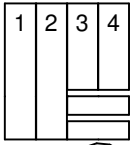
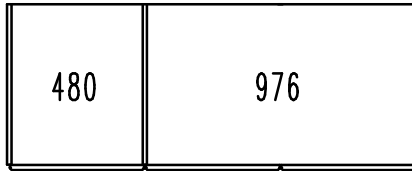

V1

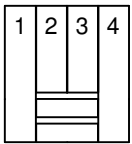
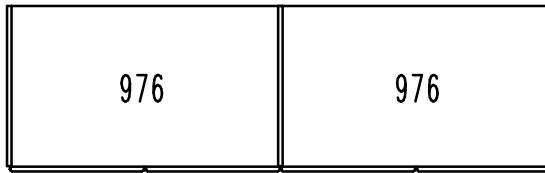

V1

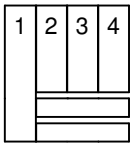
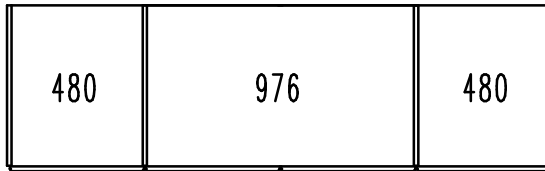

V2

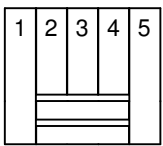
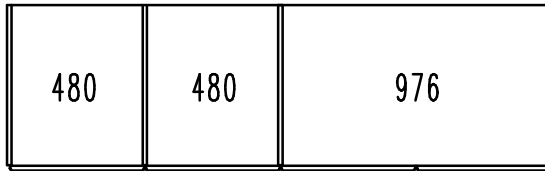

V2

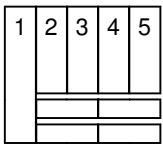
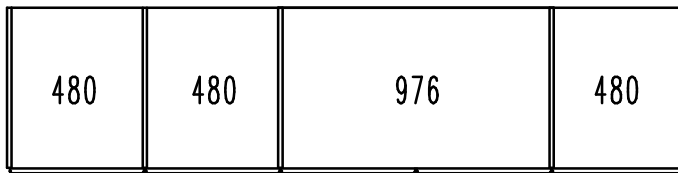

V1 V1

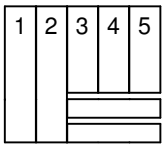
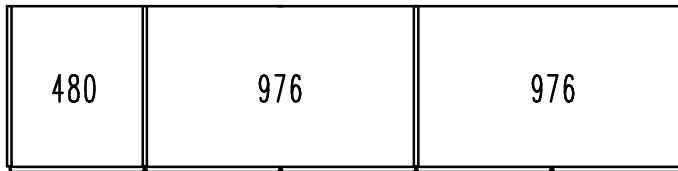

V2

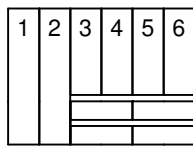
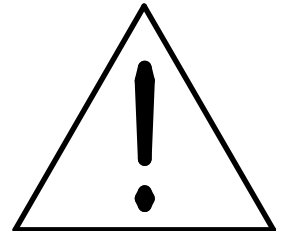
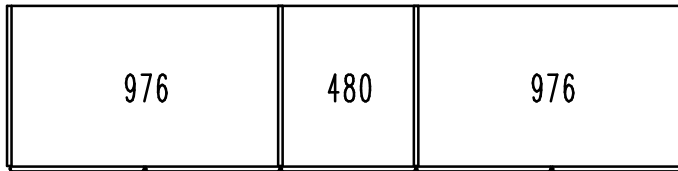

V1 V1

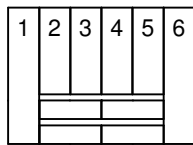
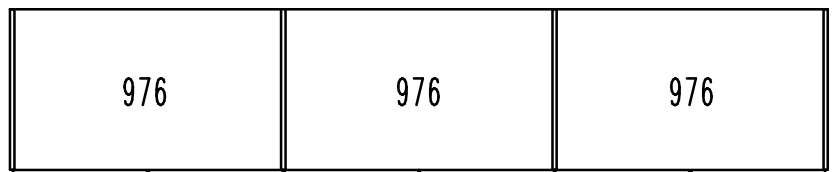

V1 V1

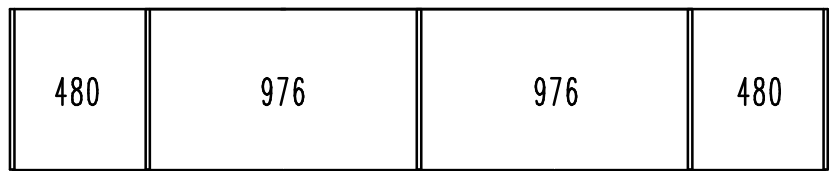

1.

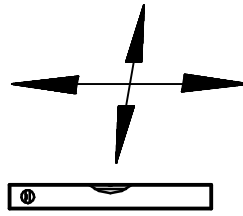

641.0227.000
12 mm



1

2

1

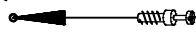

2

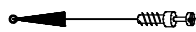

2

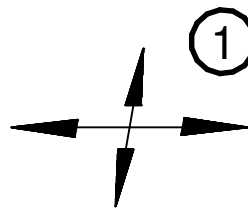
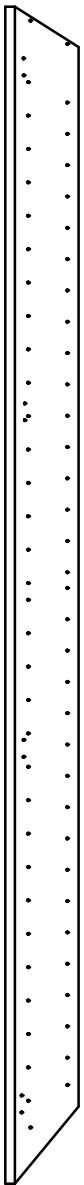

1

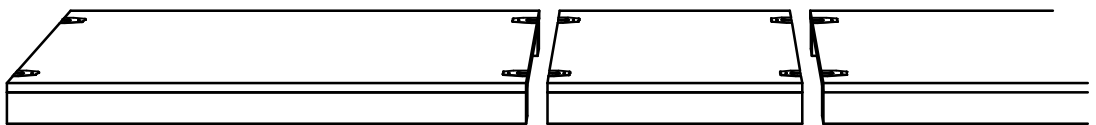

2.

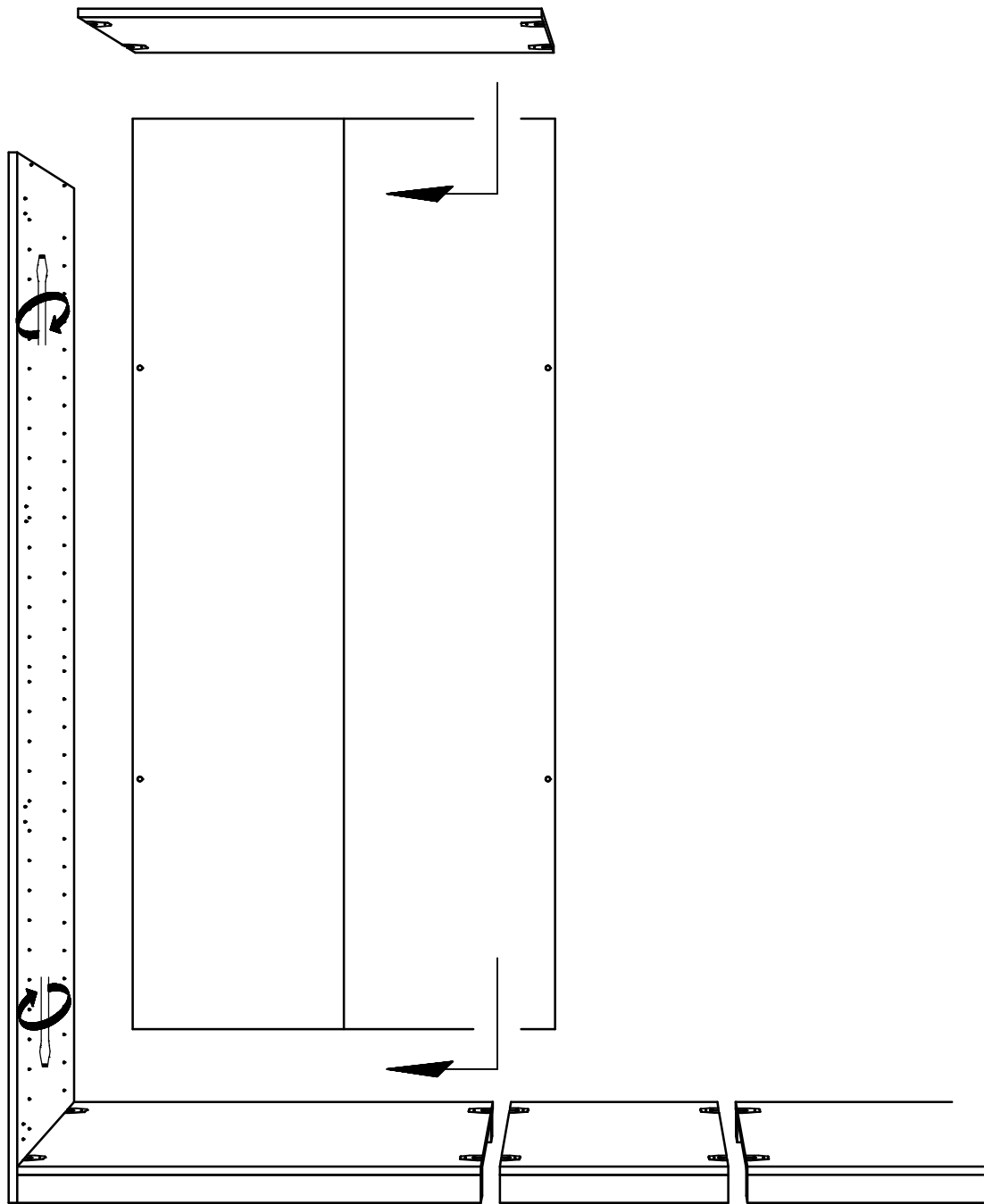

621.2930.000

631.1266.000

6,3 x 11 mm

631.1472.000

3,5 x 15 mm

641.0226.000

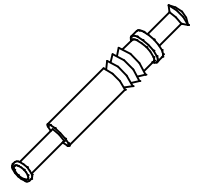
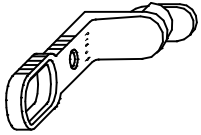

3

4

5

6

3.

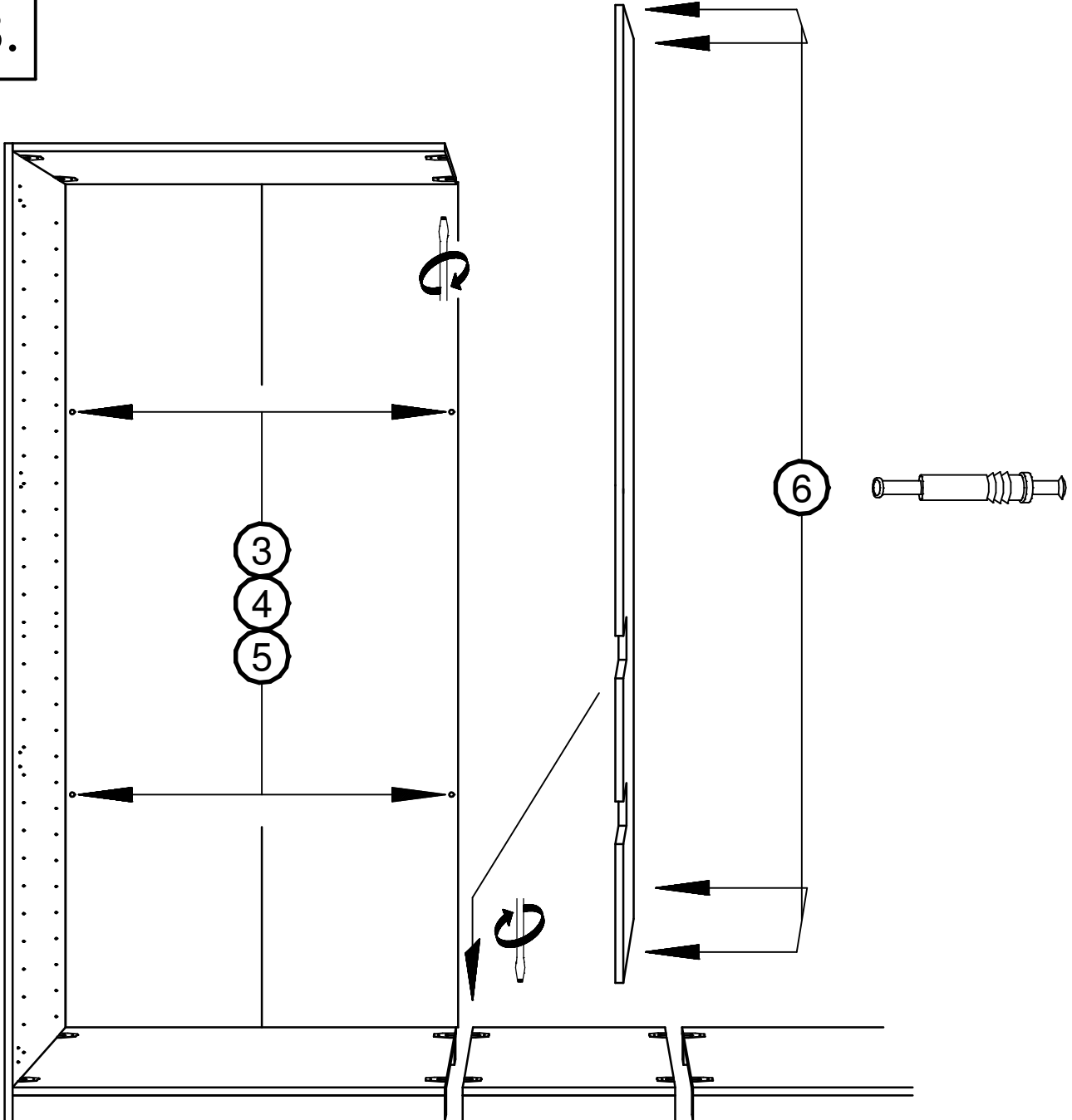

3

5

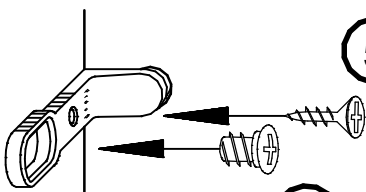

4

4.

641.0548.000

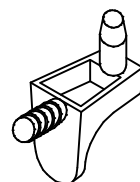

7

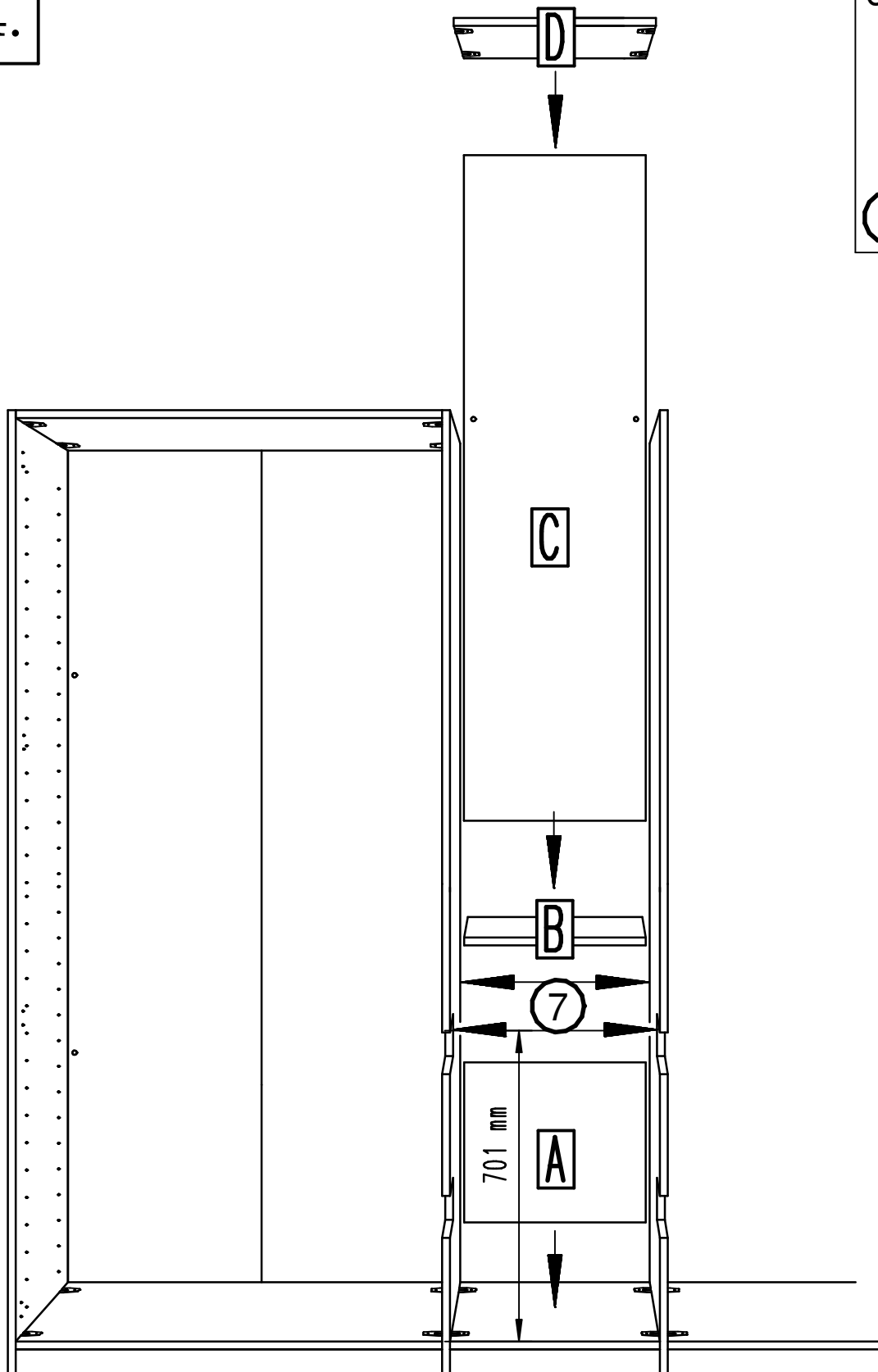

641.0204.000

632.0038.000

4 x 14 mm

621.0067.000

632.0517.000

M6 x 30 mm

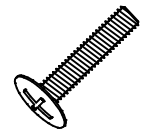
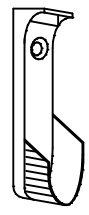
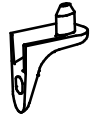

8

9

10

11

5.

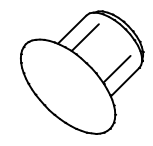

12

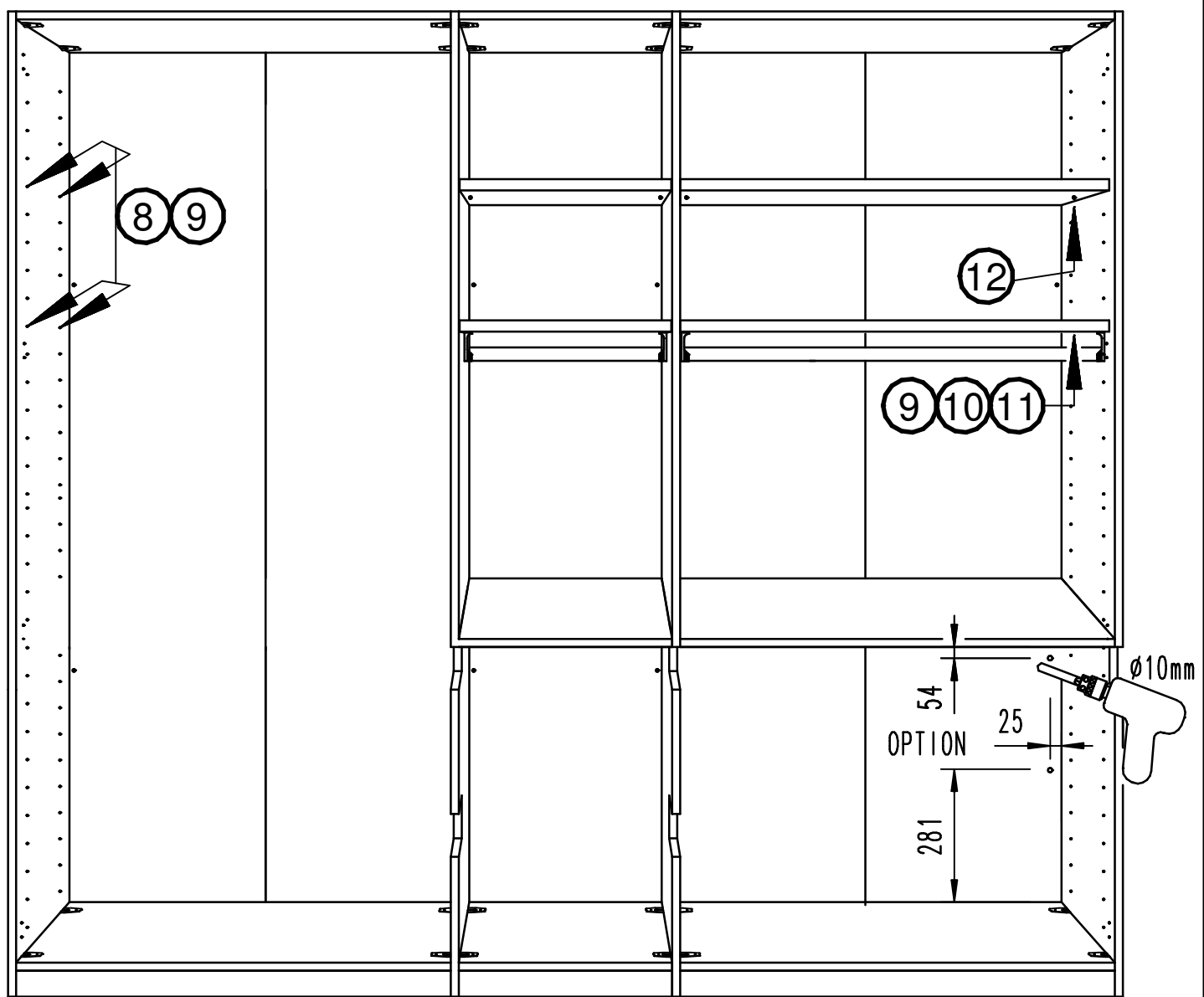

6.

632.0526.000
3 x 20 mm



13

641.0286.000



14

2 x

642.9024.000

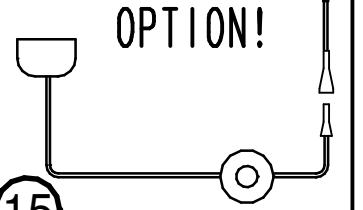

15

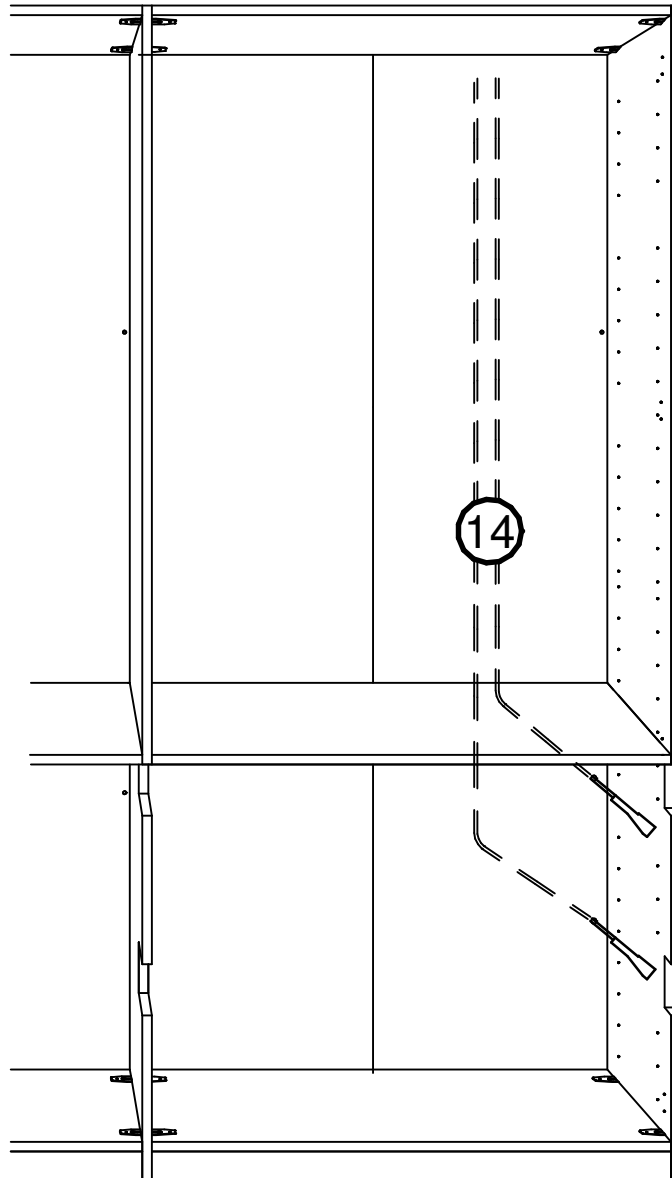
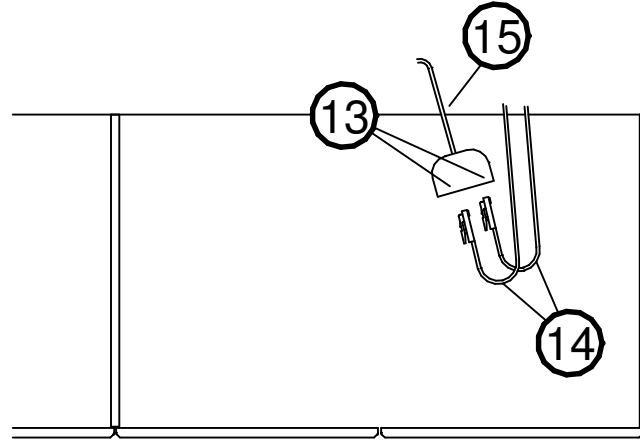

7.

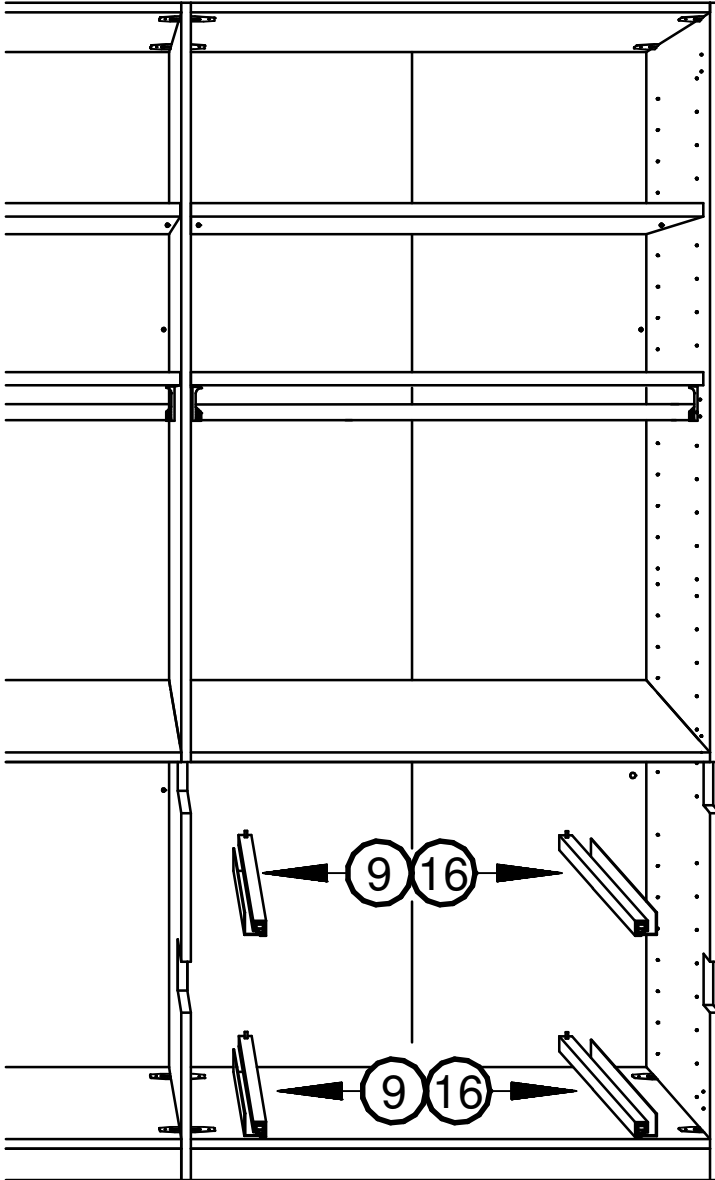

632.0545.000
6,3 x 9 mm

16



632.0038.000
4 x 14 mm

9

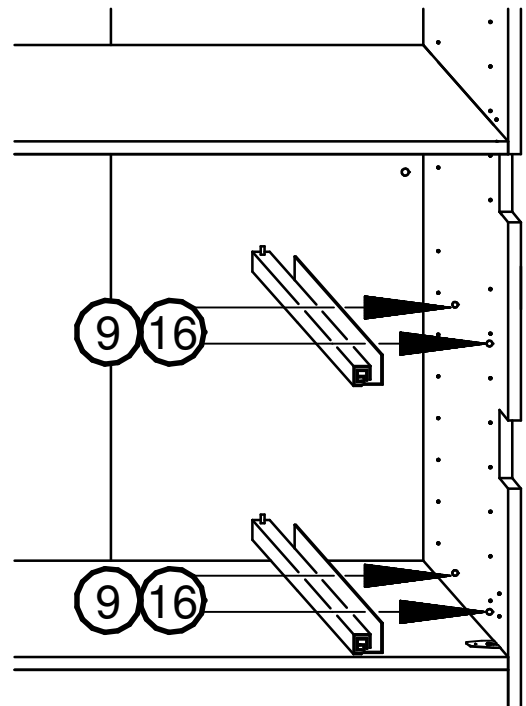
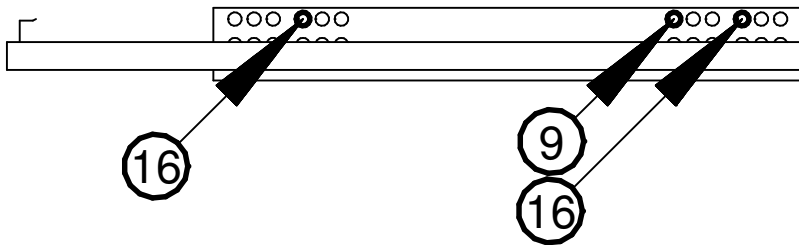

8.

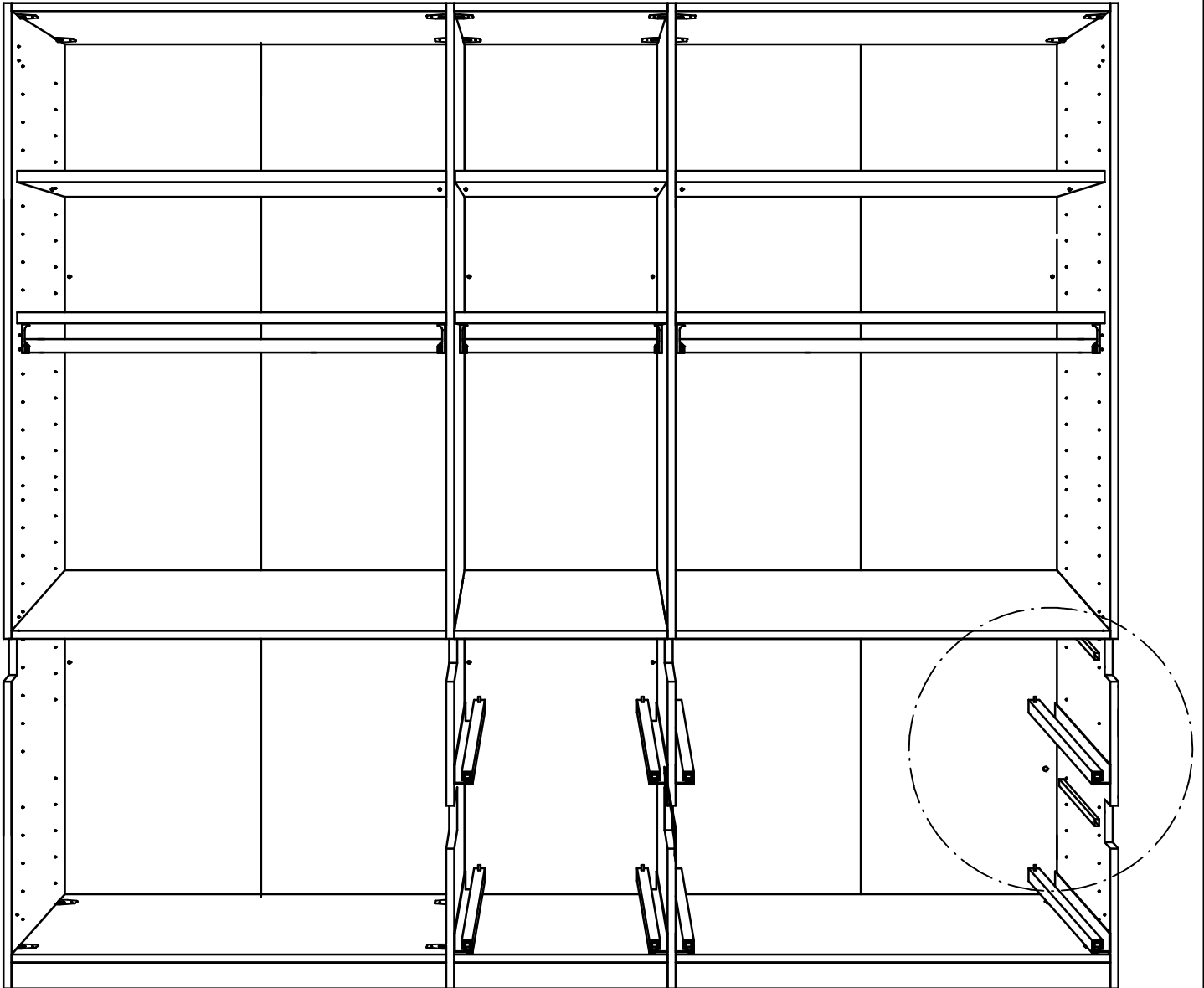

OPTION

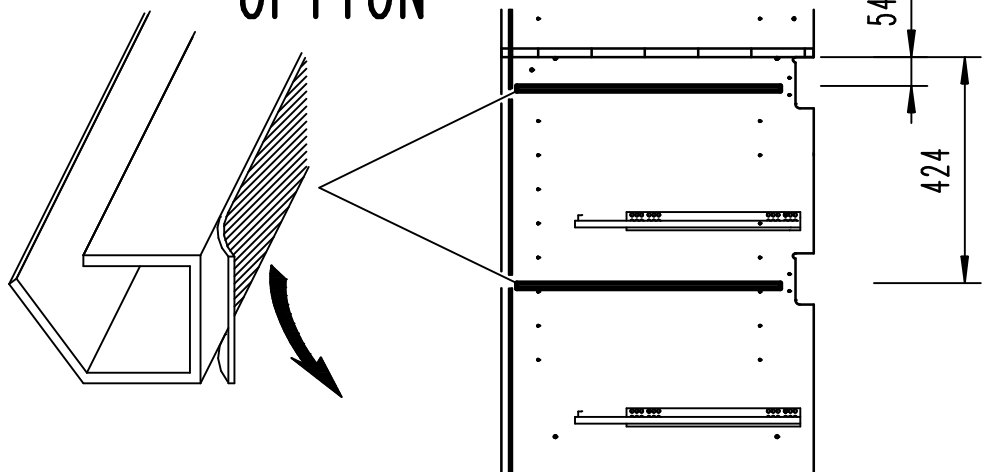

9.

631.1472.000
3,5 x 15 mm

641.0381.000

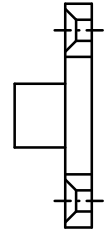

5

17

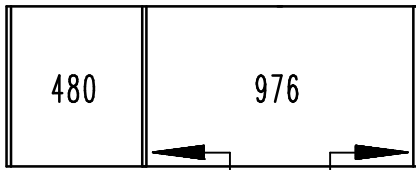
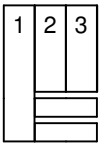

17 5

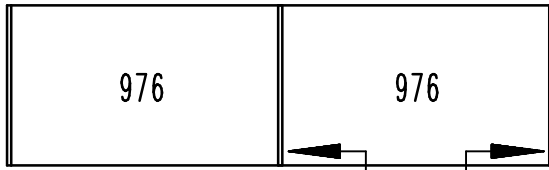
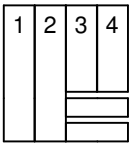

17 5

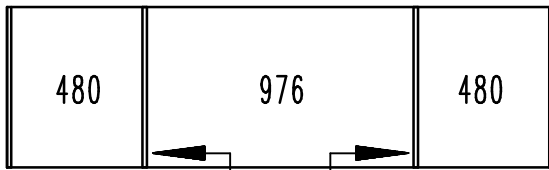
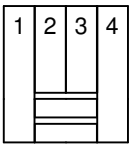

17 5

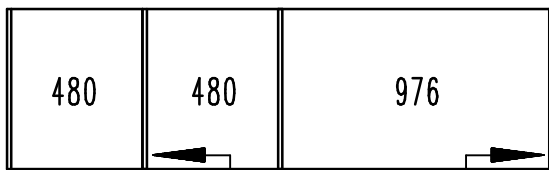
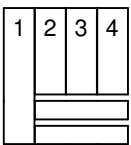

17 5

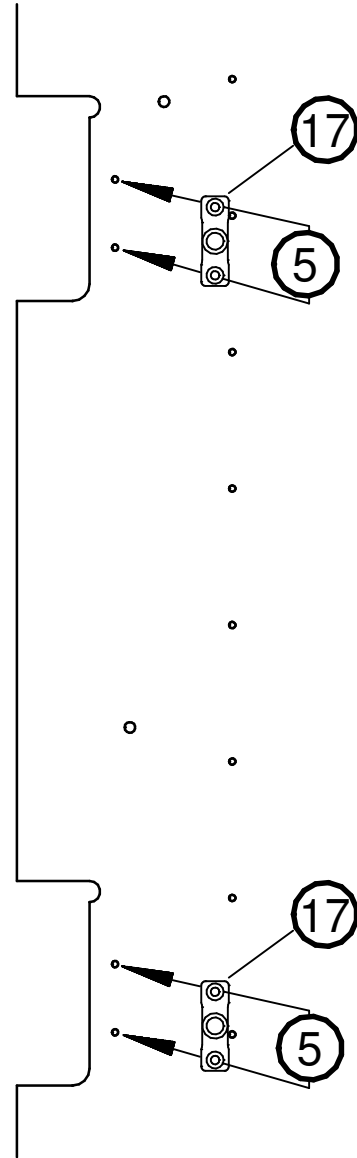

9.1



631.1472.000
3,5 x 15 mm



5

641.0381.000

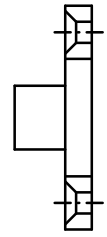

17

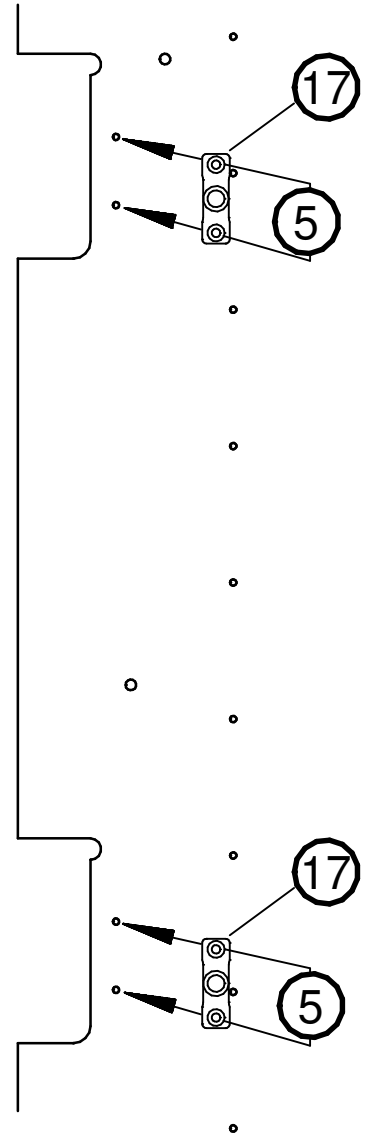
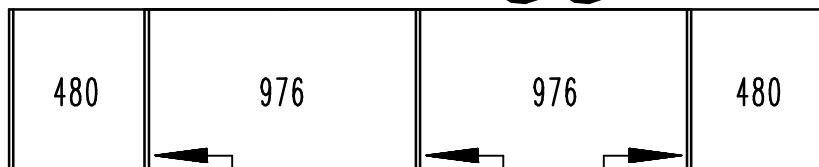
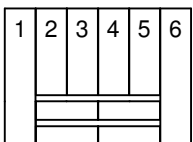
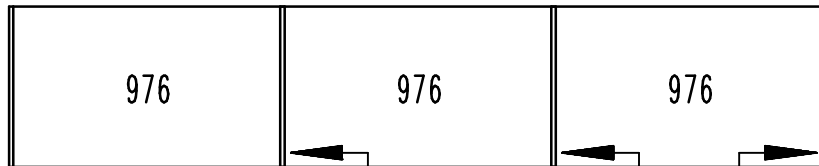
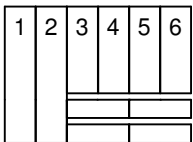
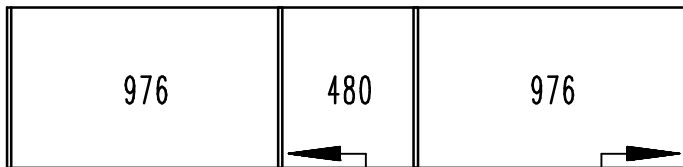
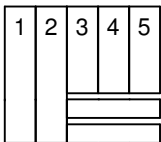
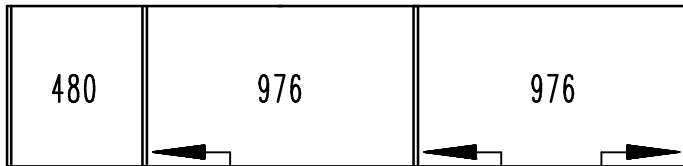
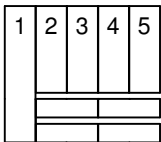
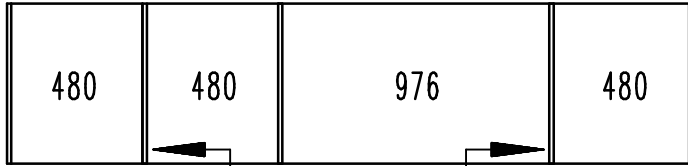
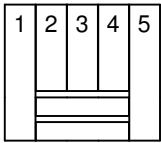

10.

631.1472.000
3,5 x 15 mm

641.0380.000



5



18

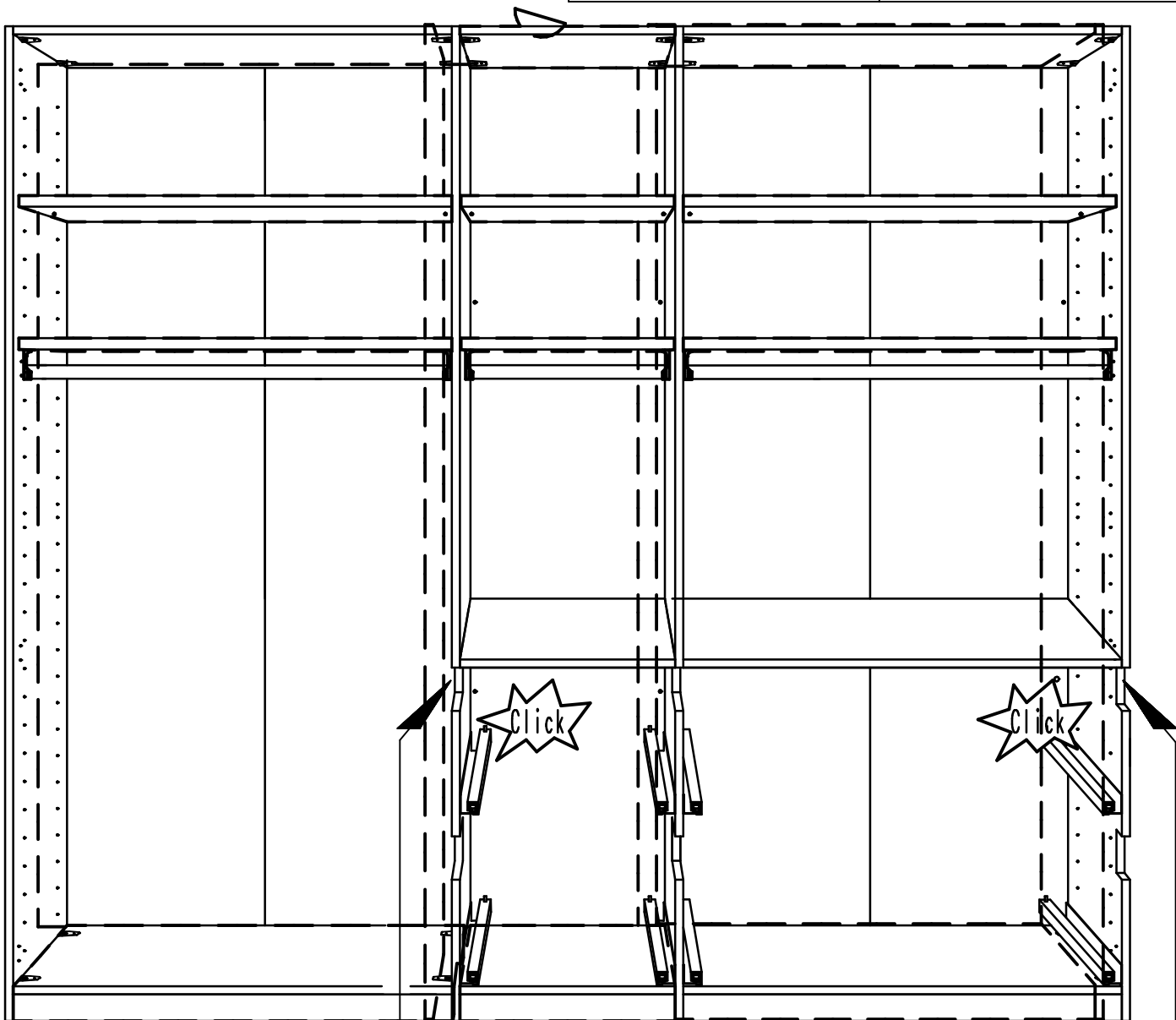

5 18

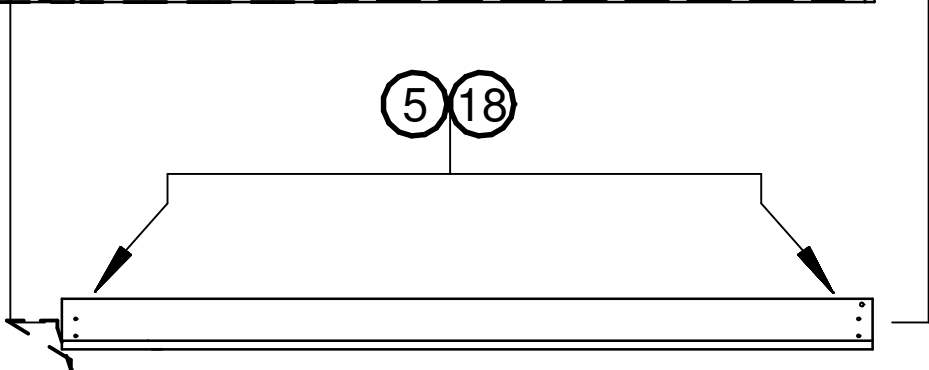

*Dieses Produkt enthält eine Lichtquelle der Energieeffizienzklasse <F>

11.

631.1472.000
3,5 x 15 mm

641.0380.000

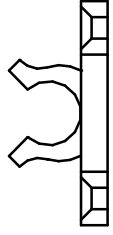

5

18

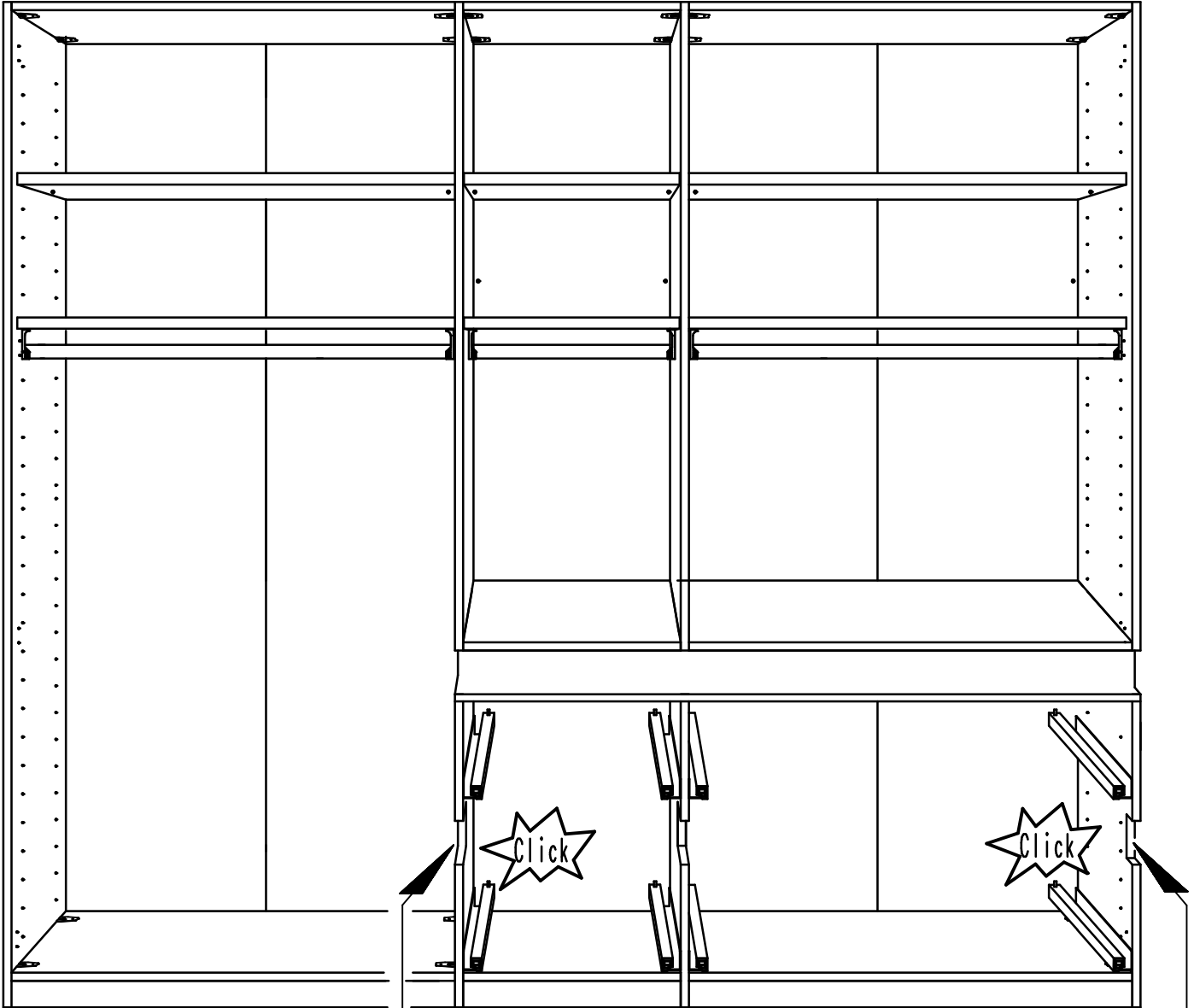

5 18

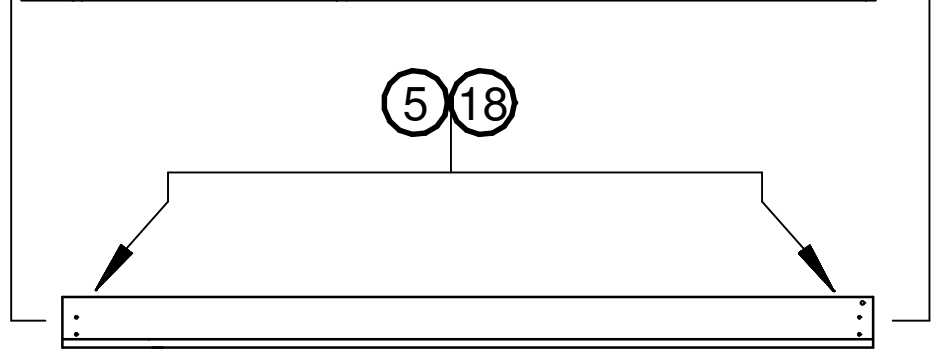

12.

631.1504.000
3,5 x 17 mm



19

641.1338

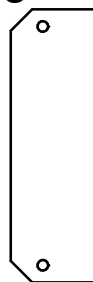

20

641.1339.000

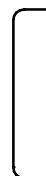

21

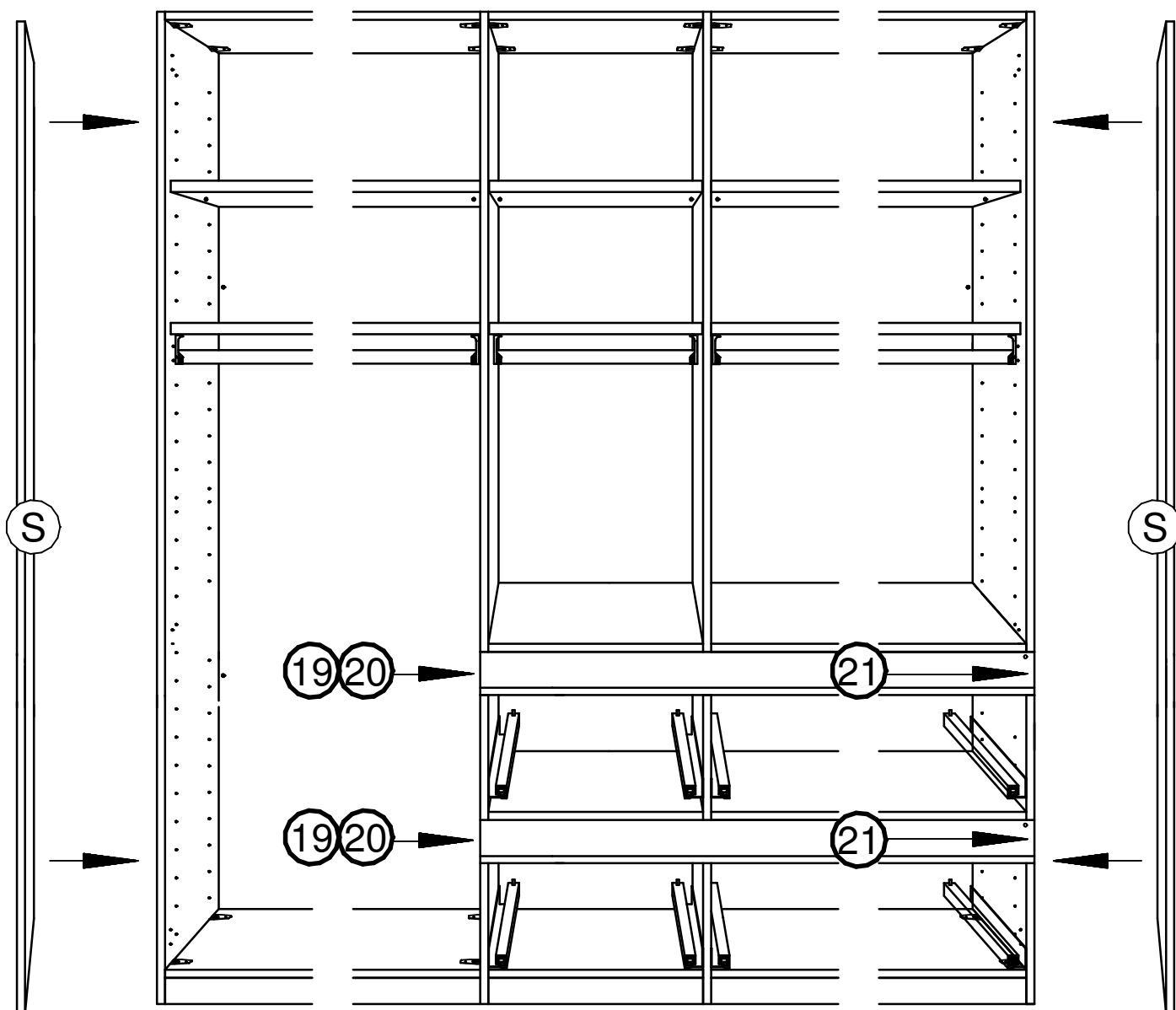

13.

623.0054.000



22

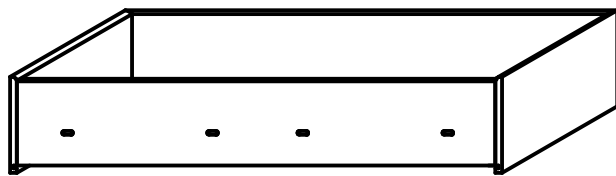
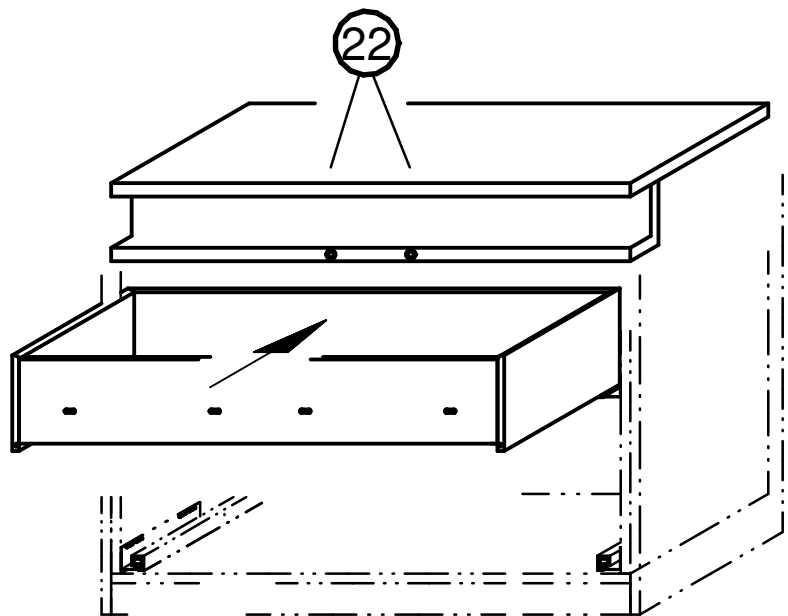

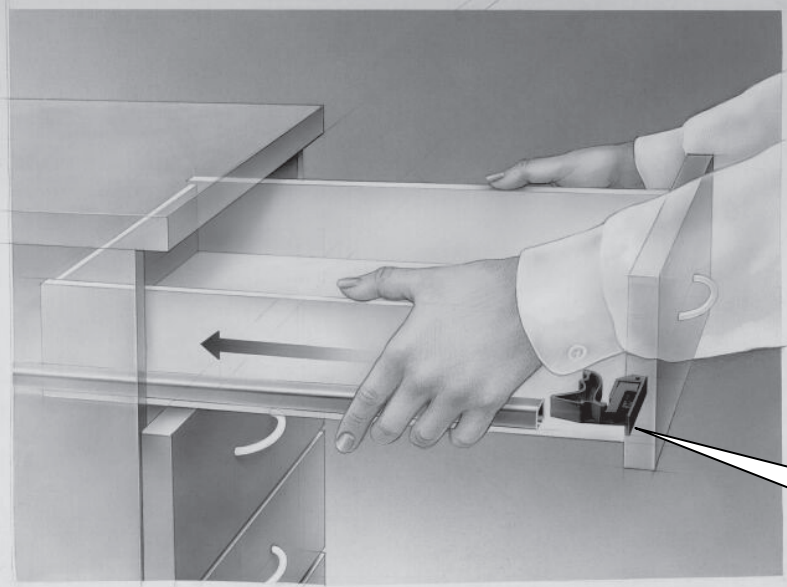

click

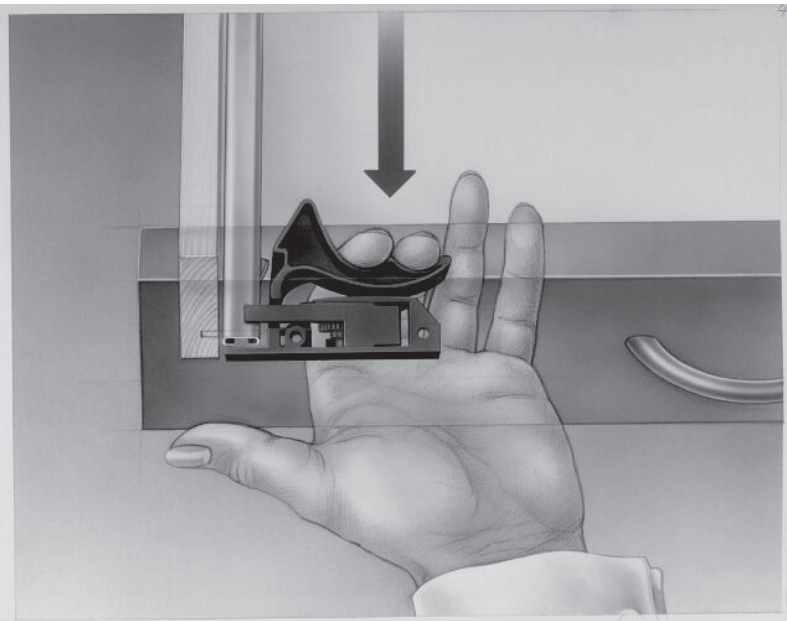
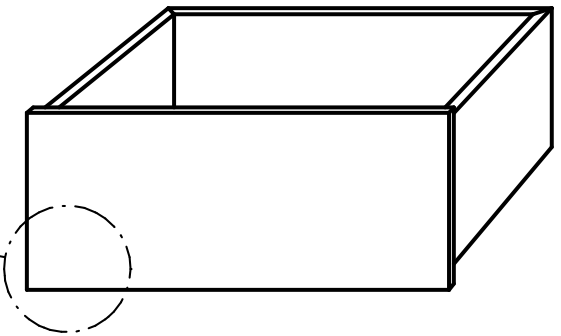
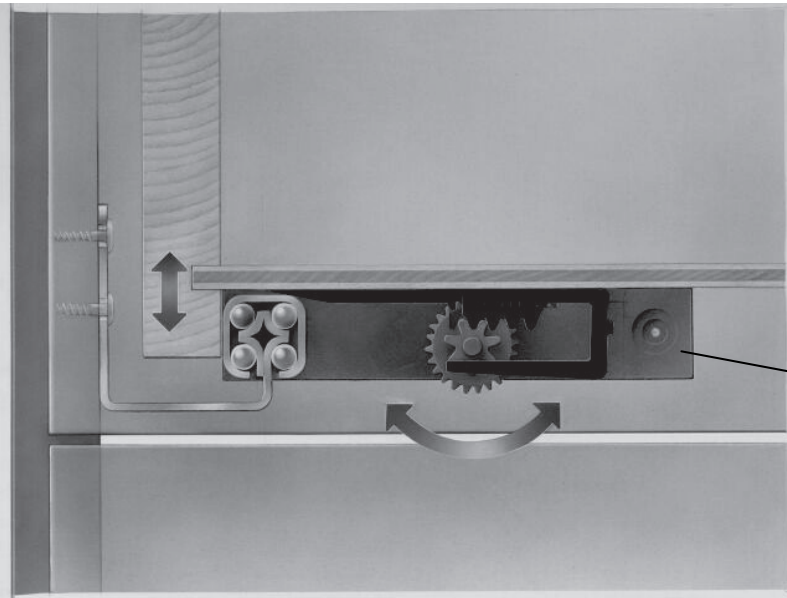

14.

632.0500.000
M6 x 25 mm

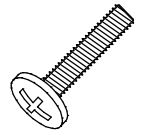

23

23

23

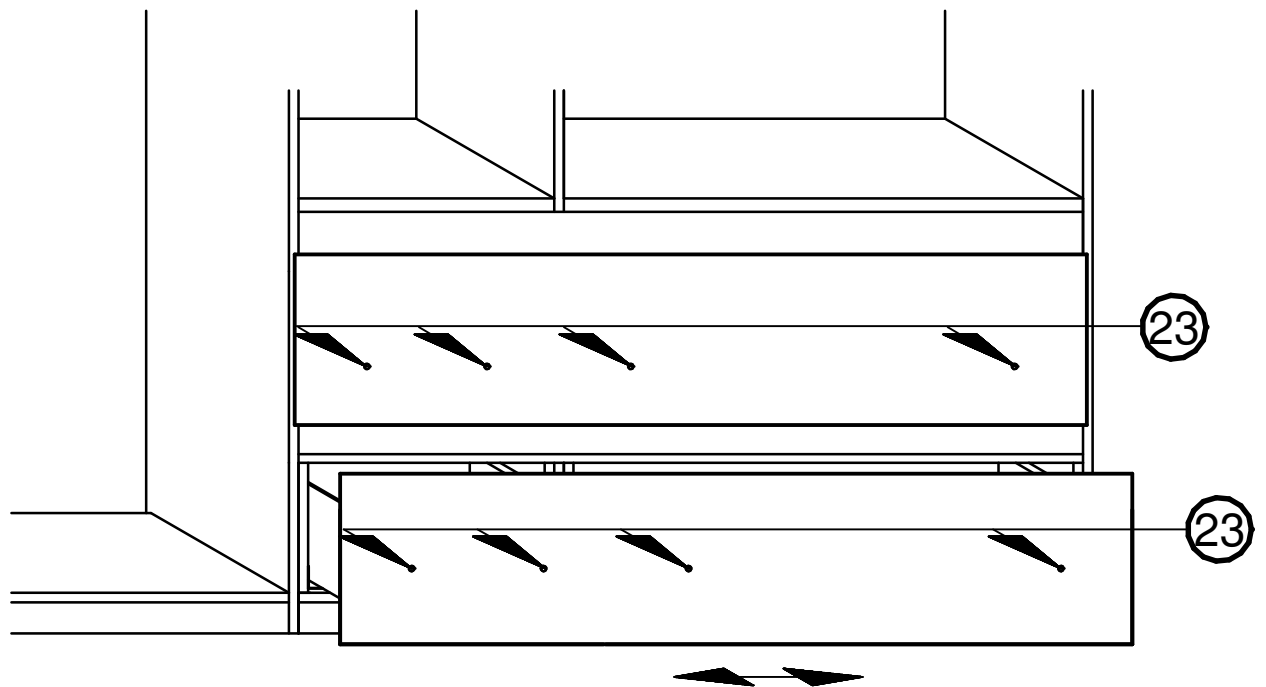
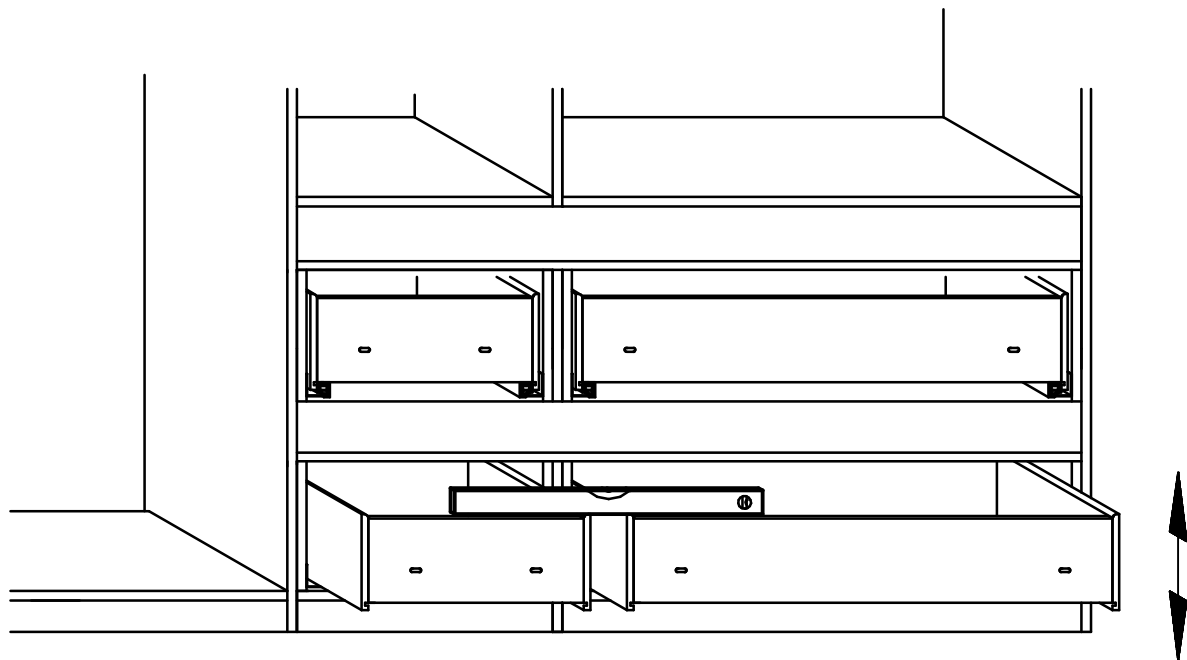
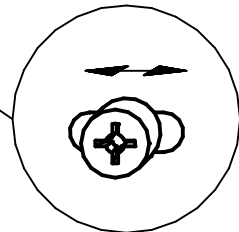

15.

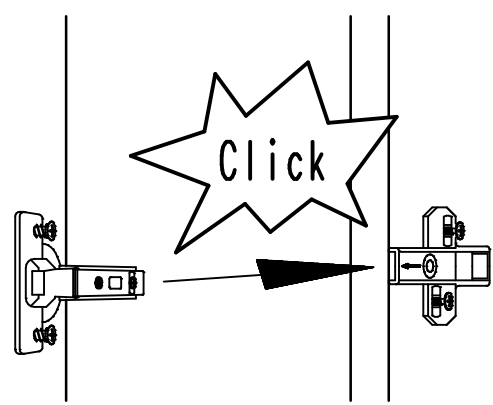
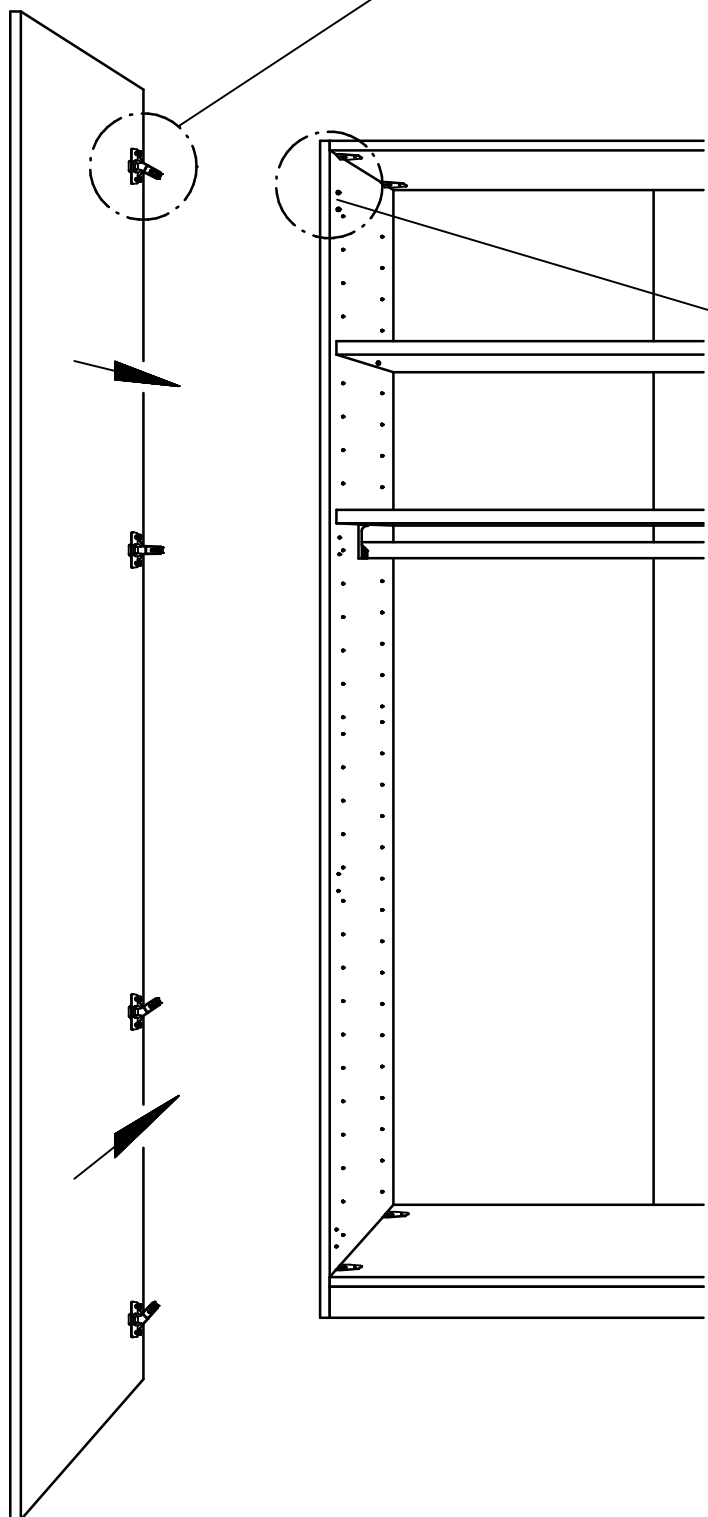
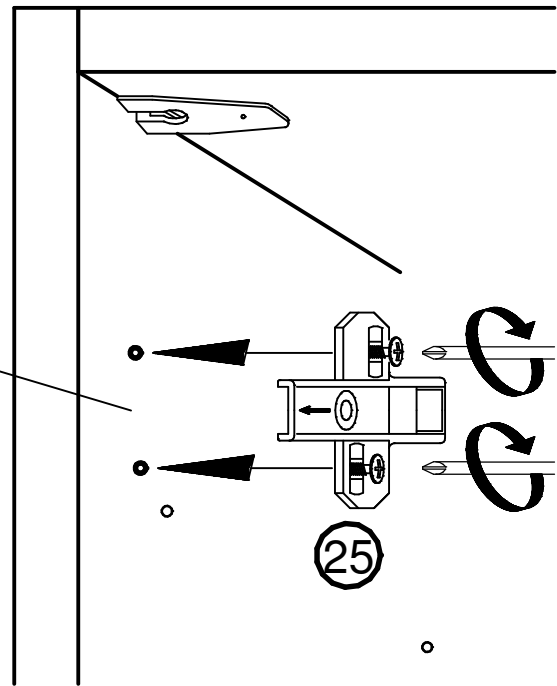
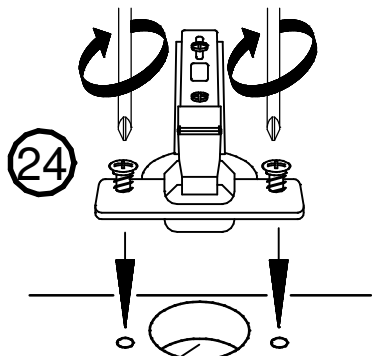
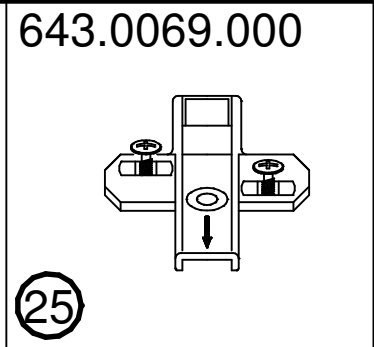
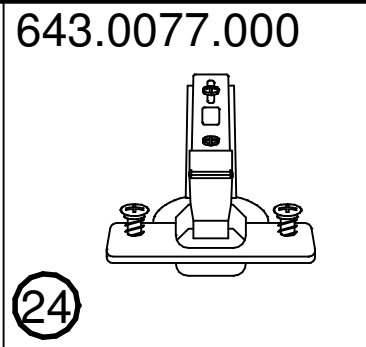

16.

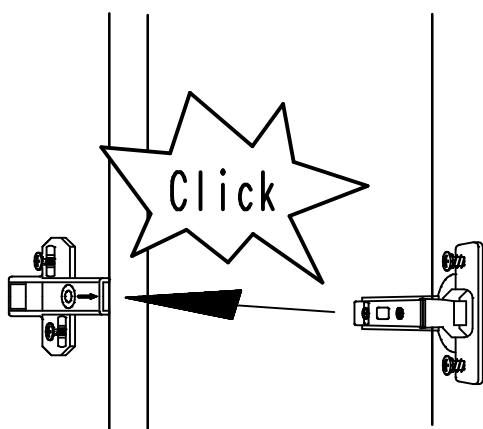
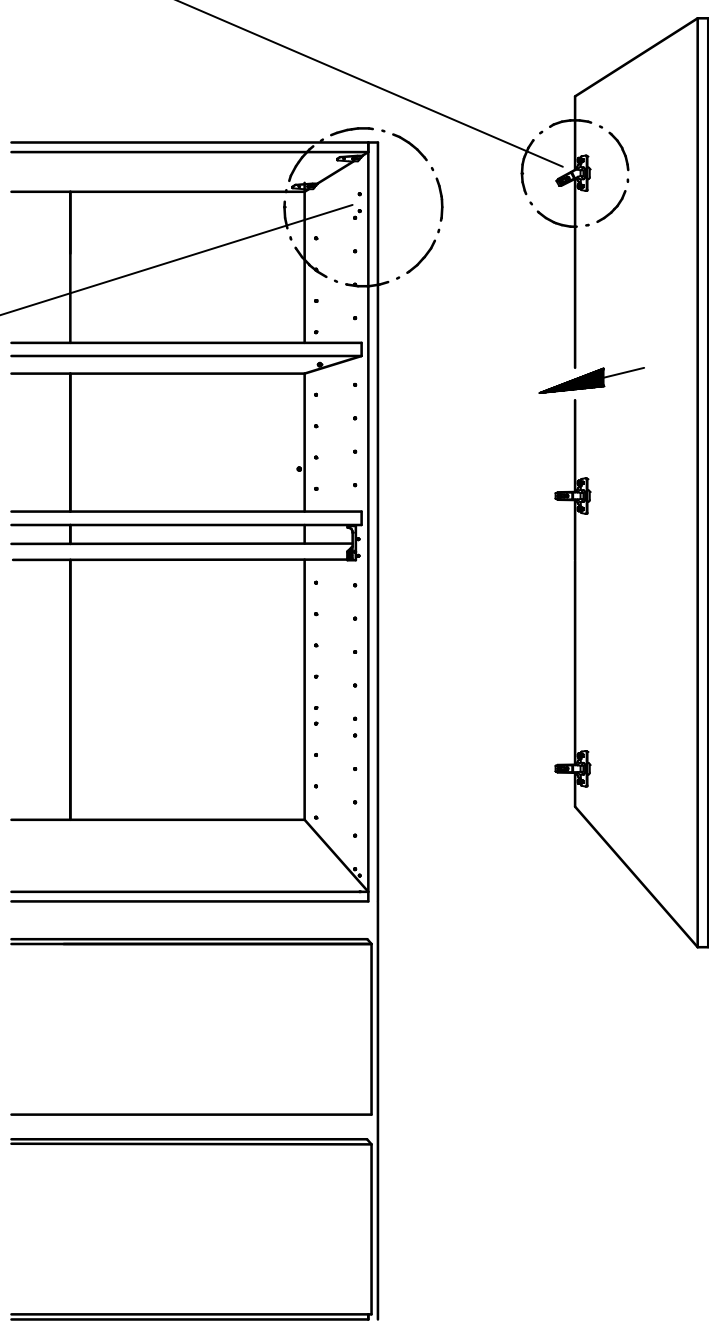
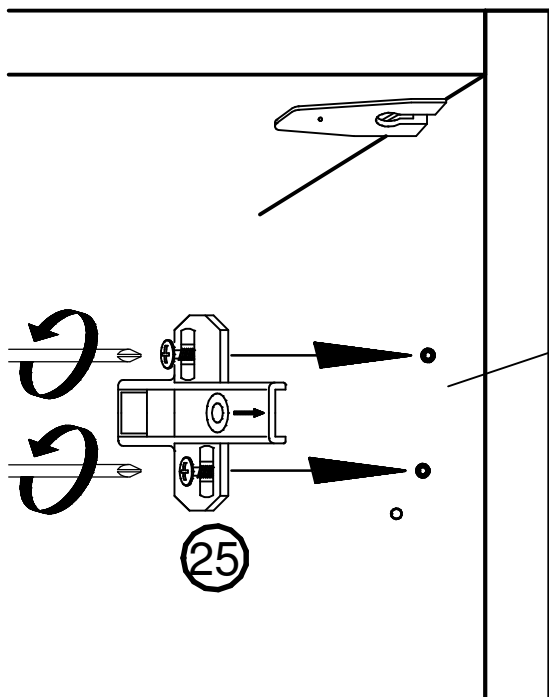
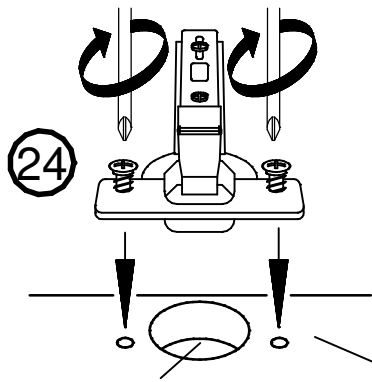
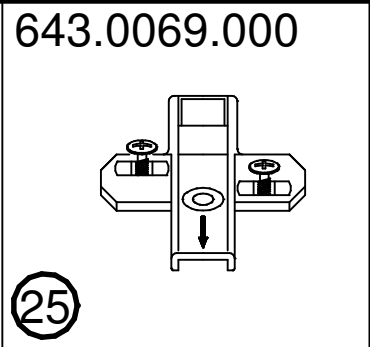
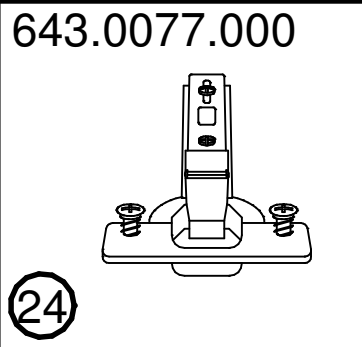

17.

