

20.03.1306.00

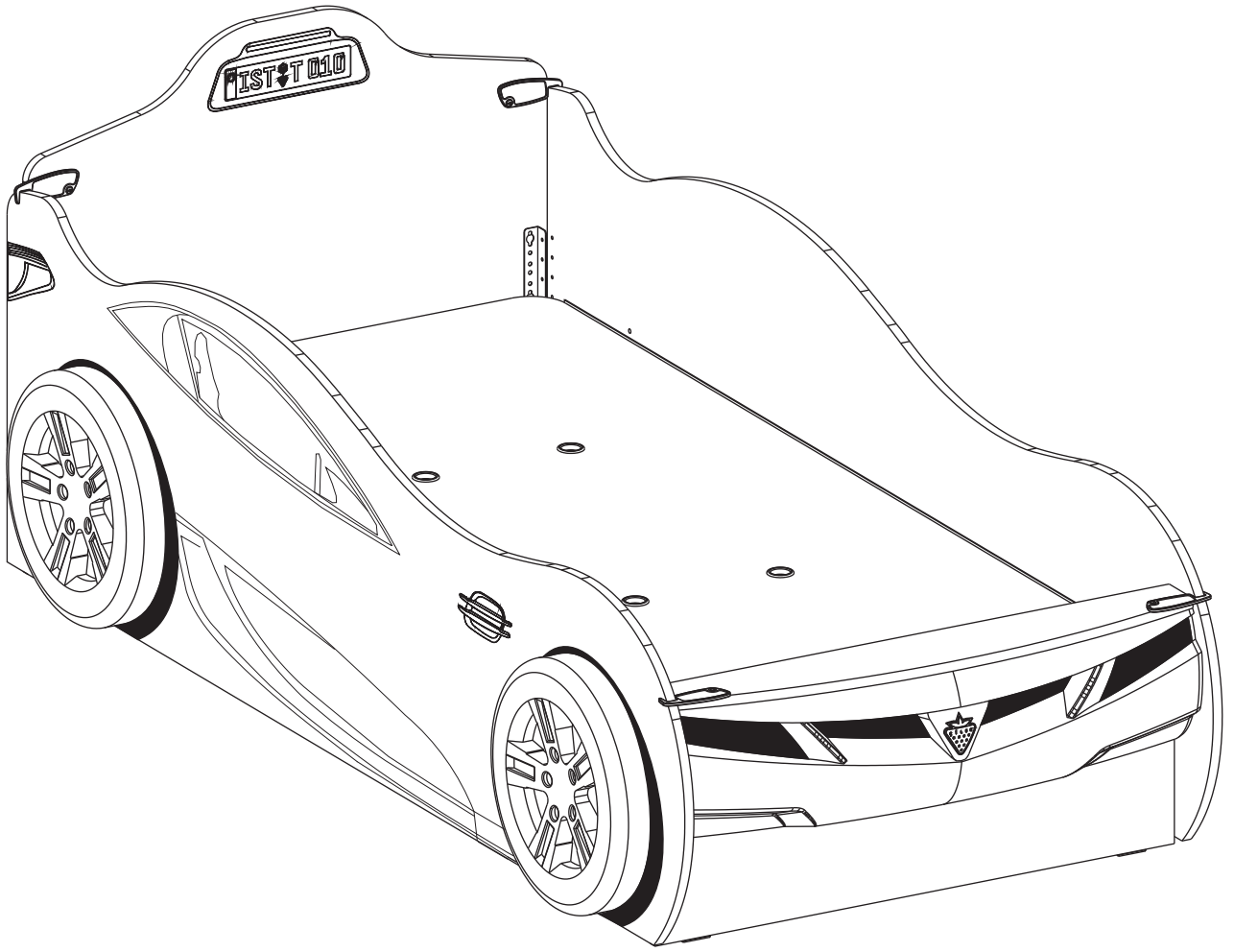

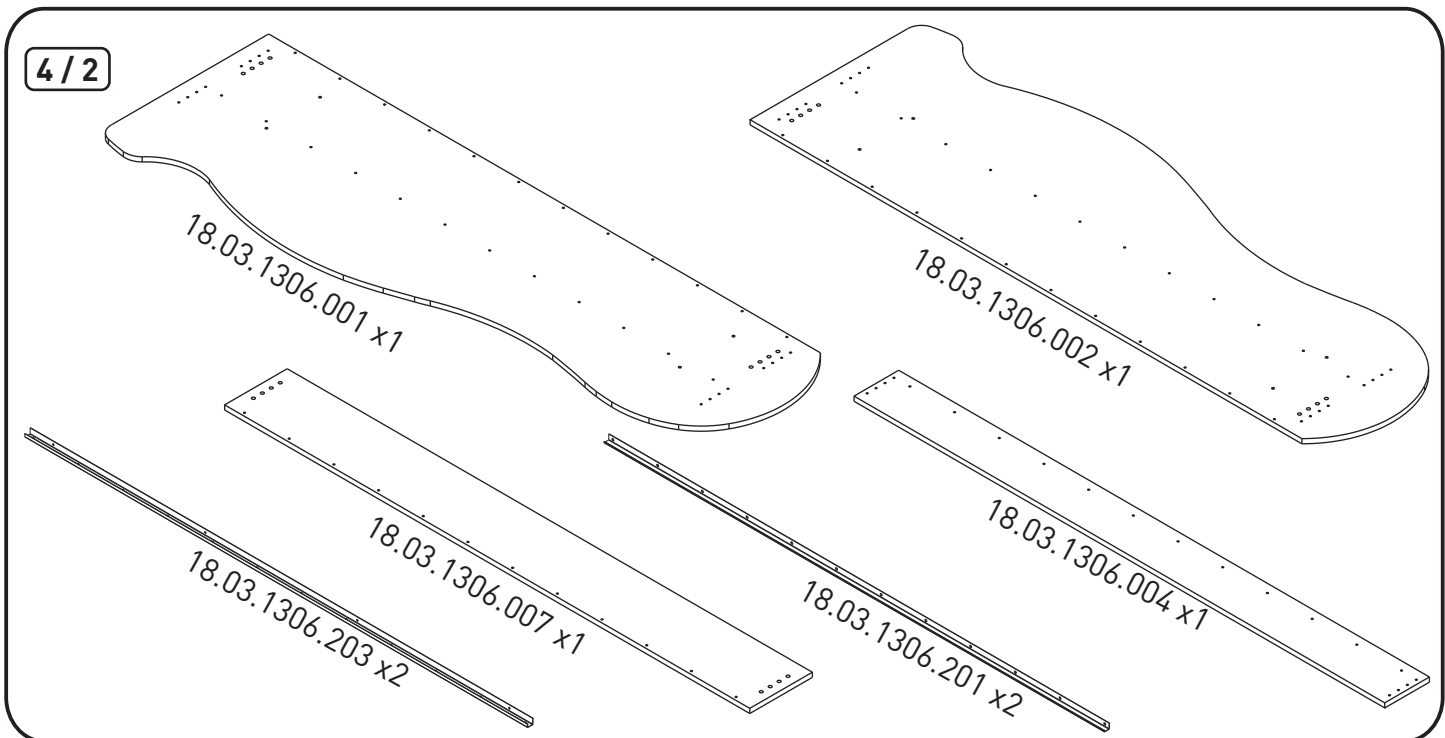

4/1

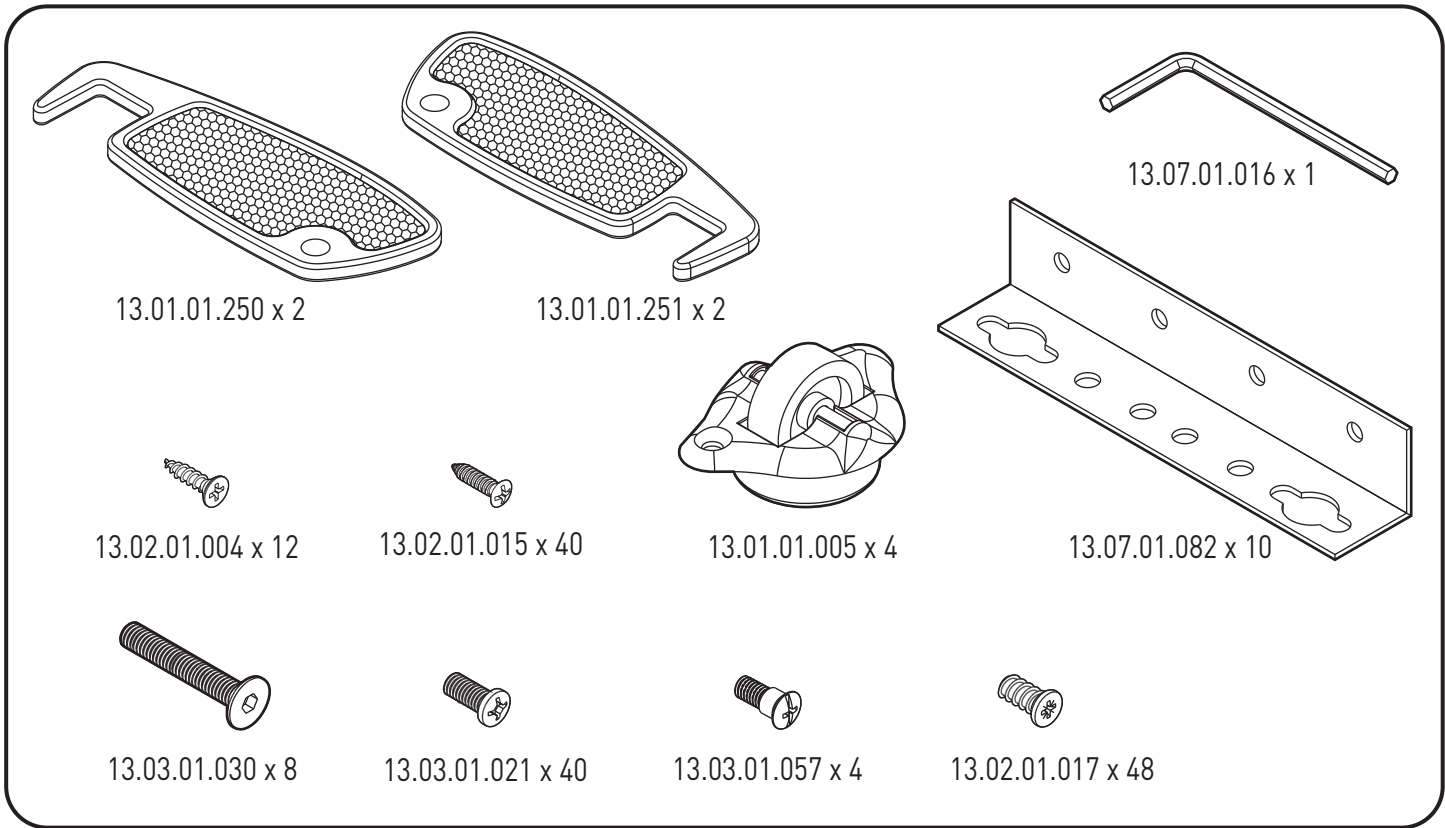
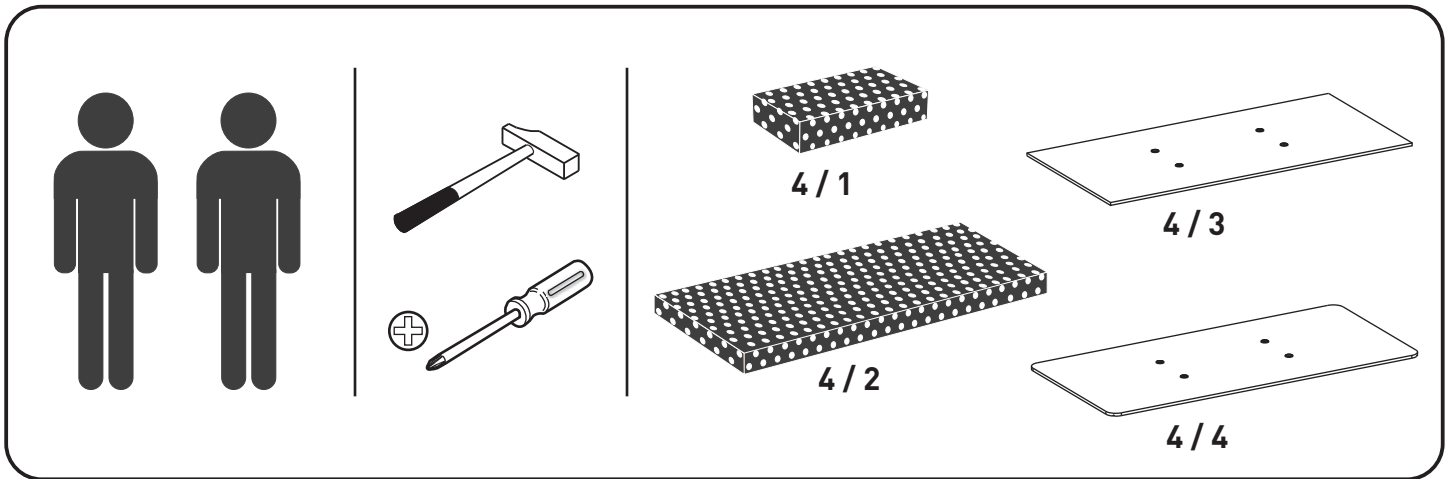
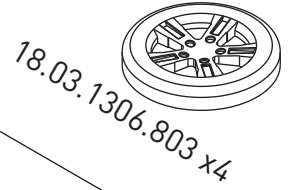
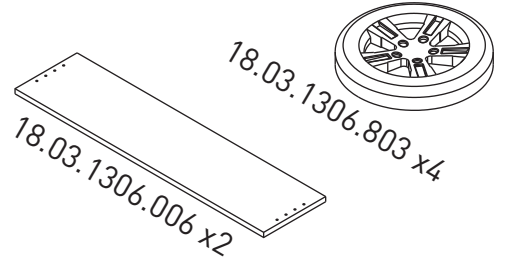
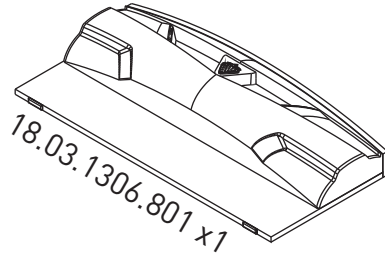
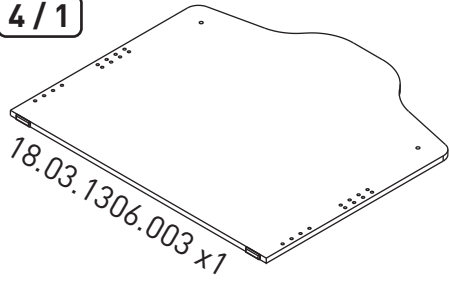

4/3

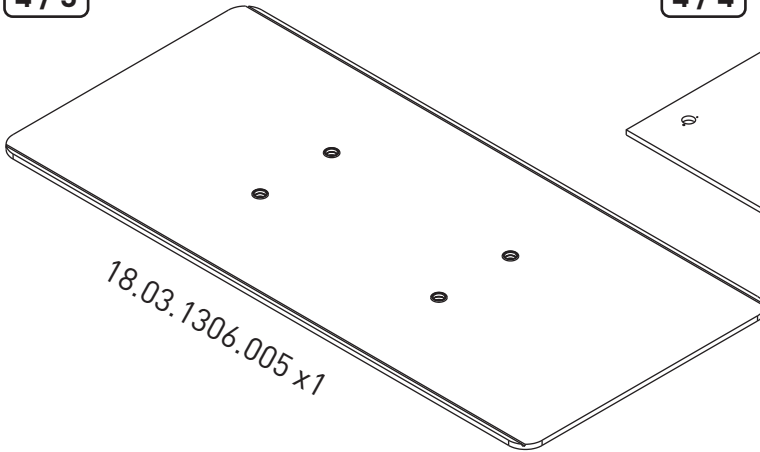

4/4

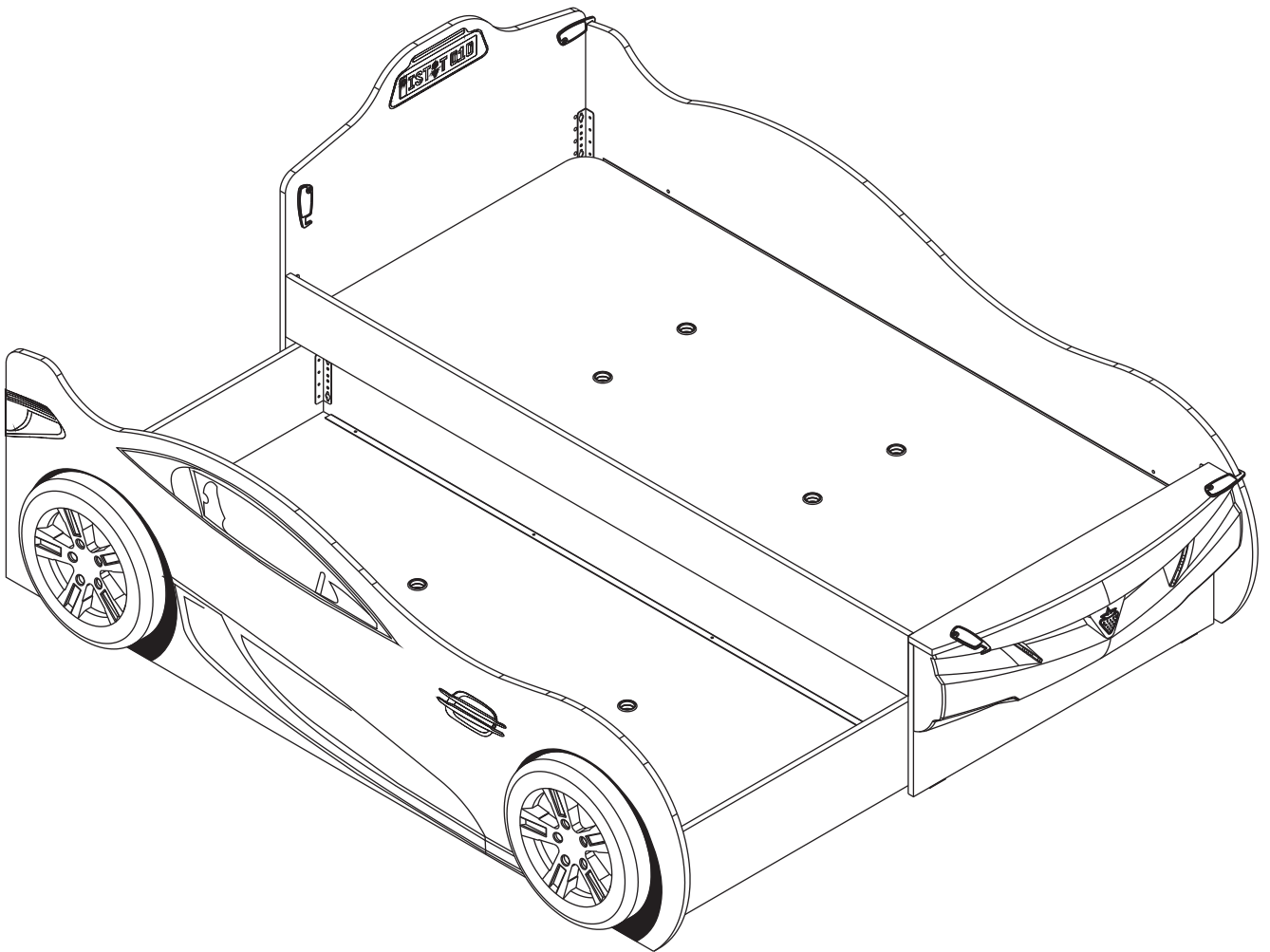
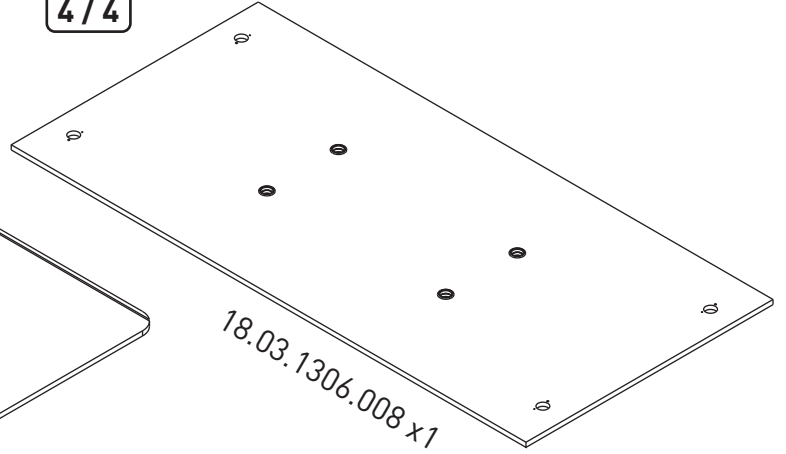

1

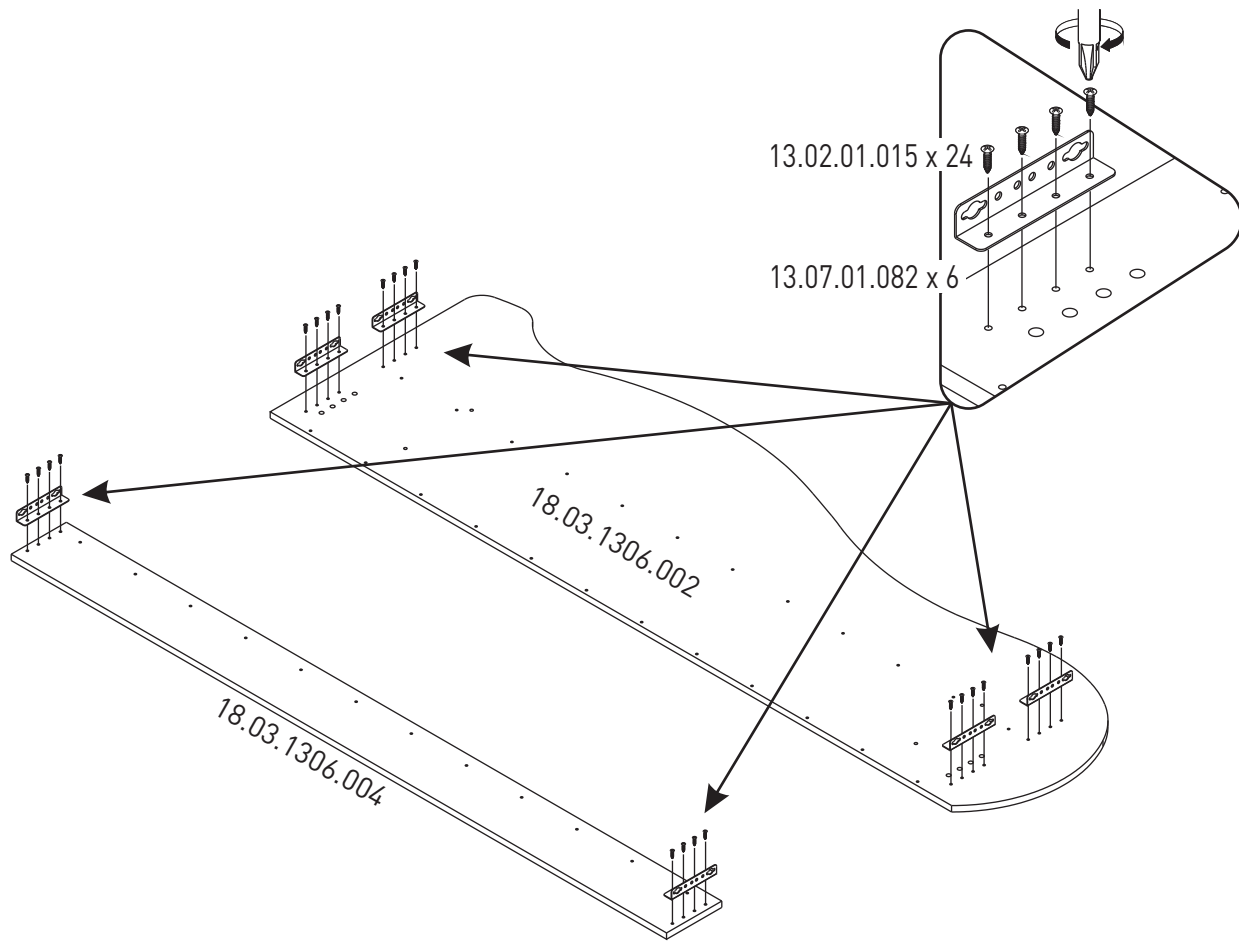

2

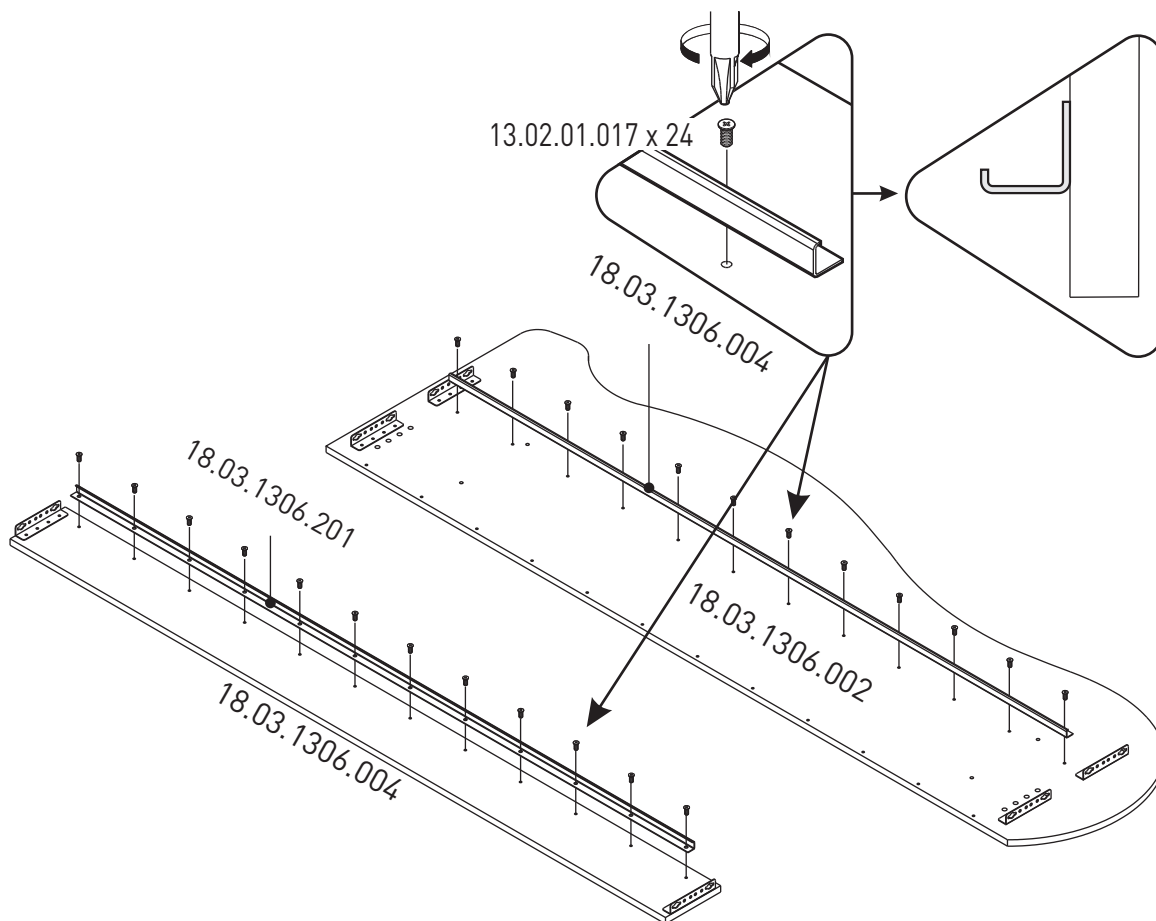

3

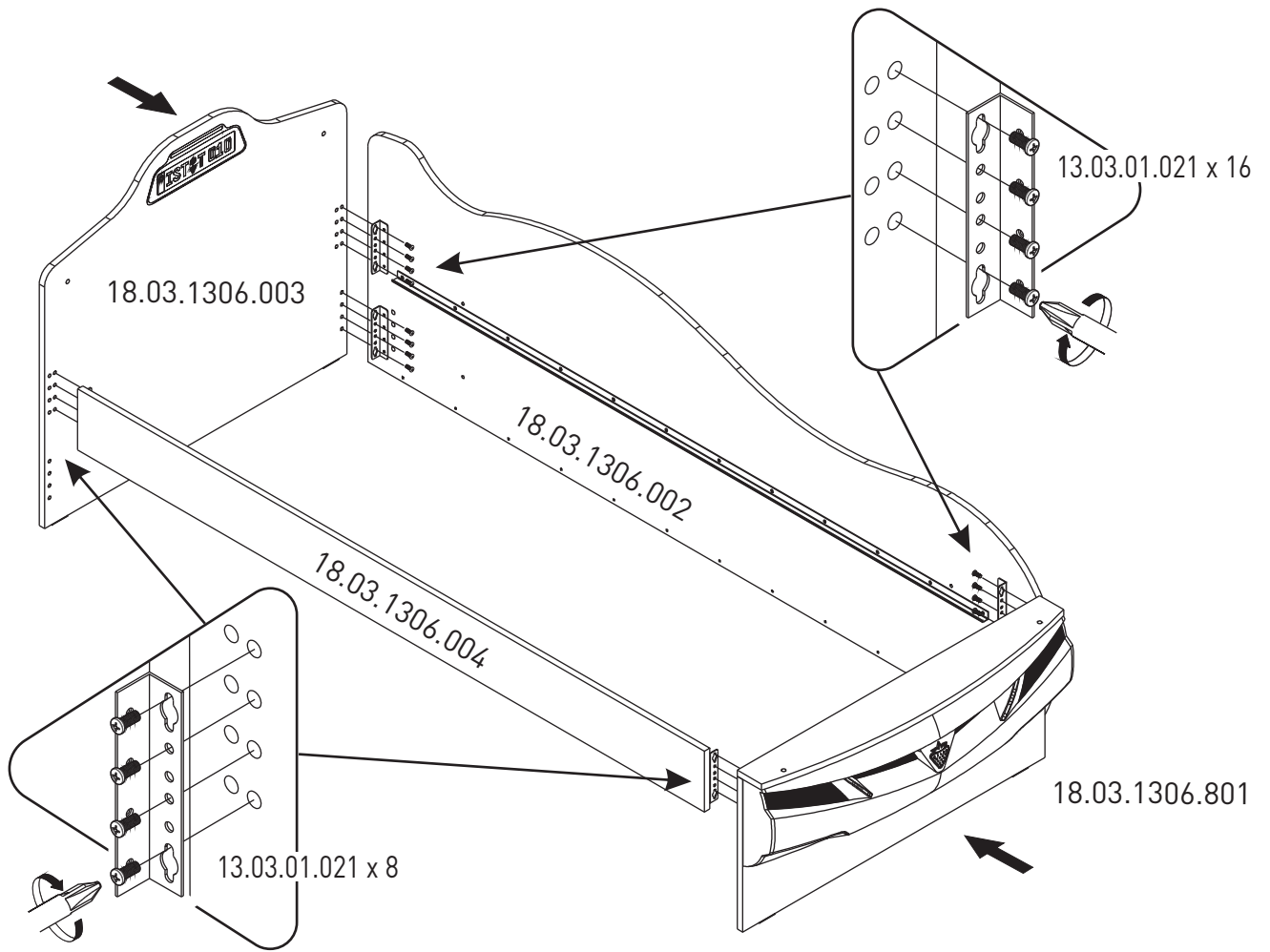

4

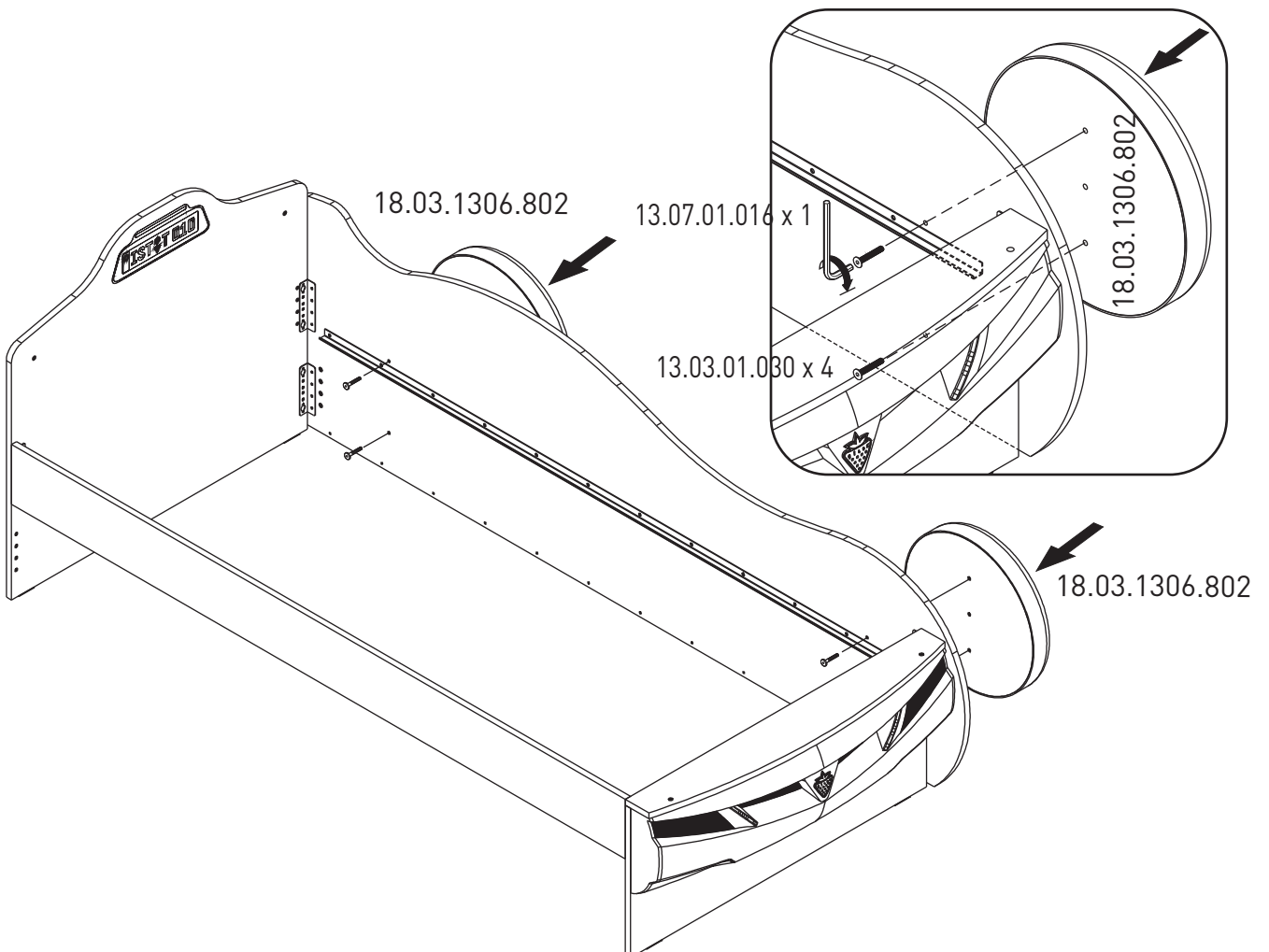

5

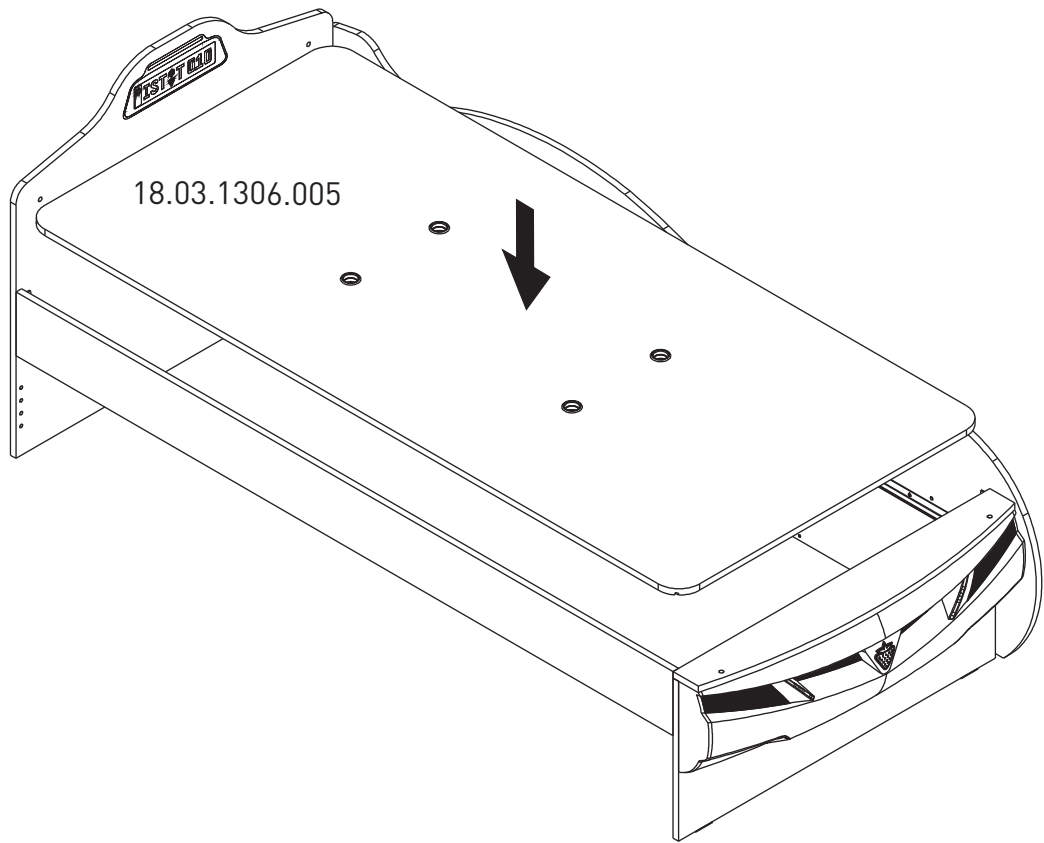

6

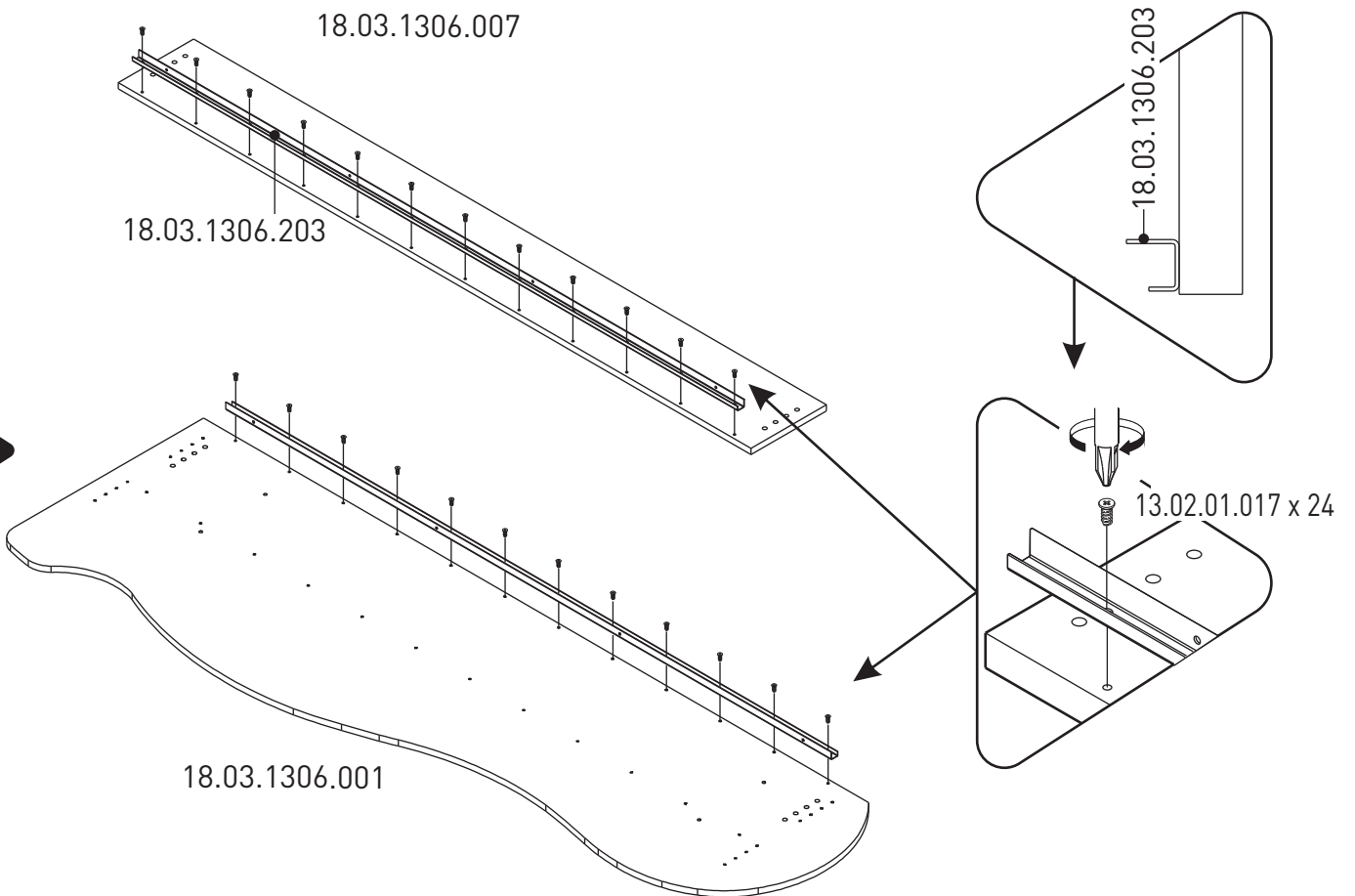

7

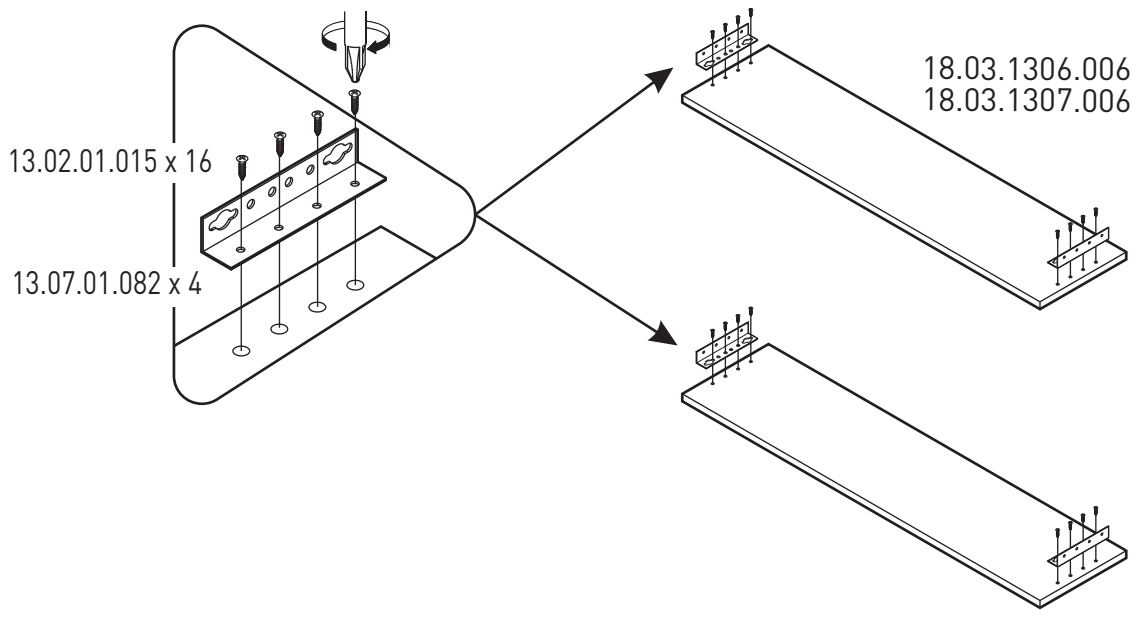

8

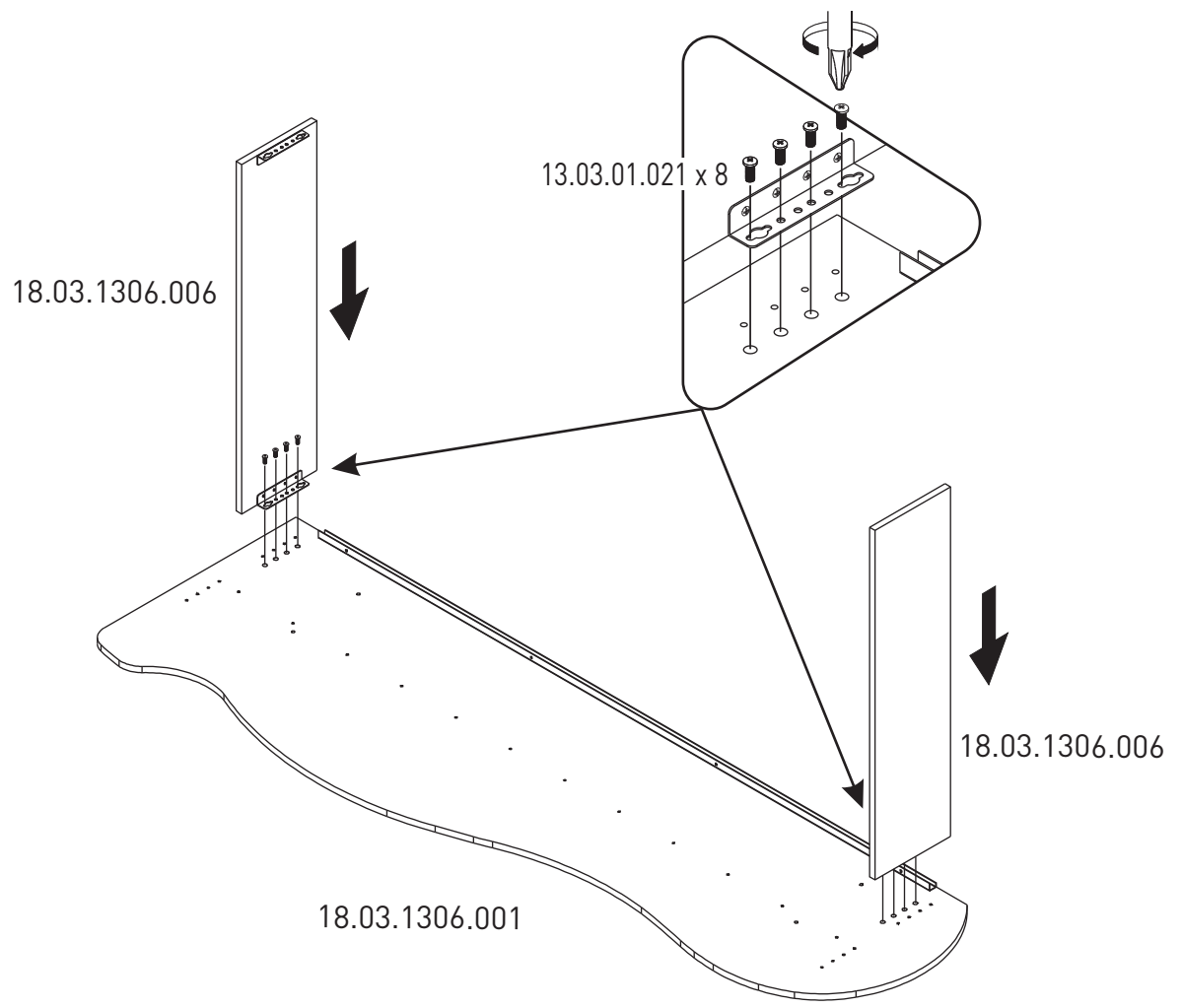

9

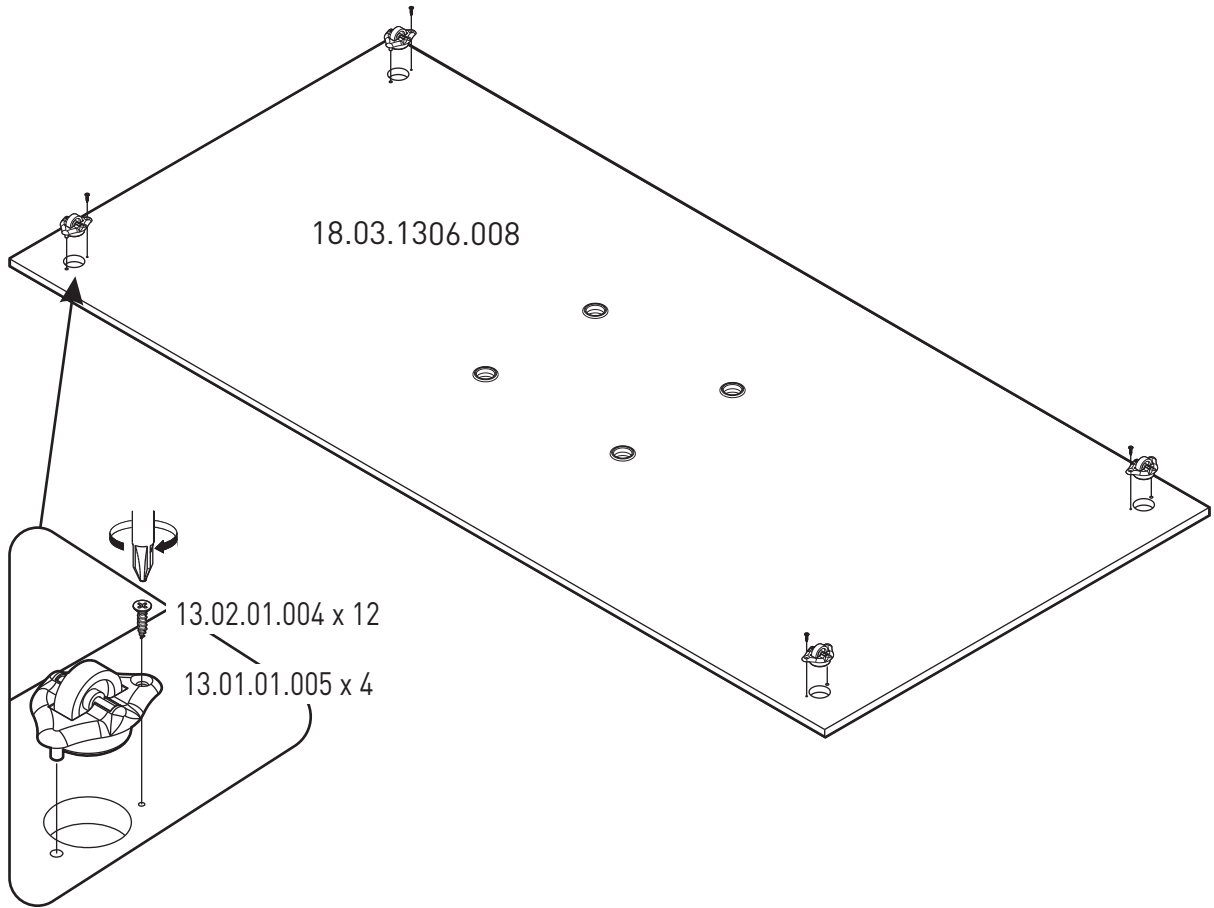

10

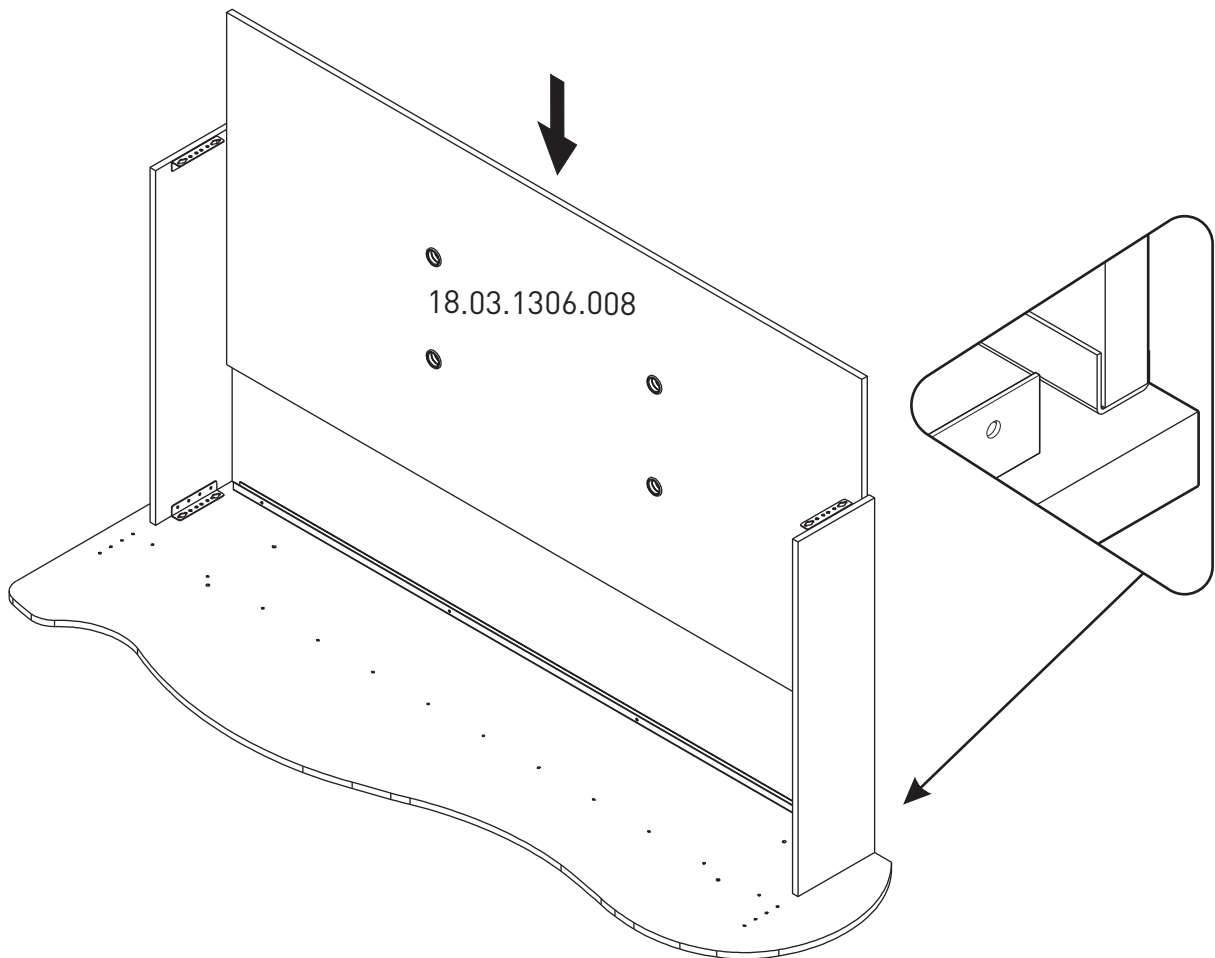



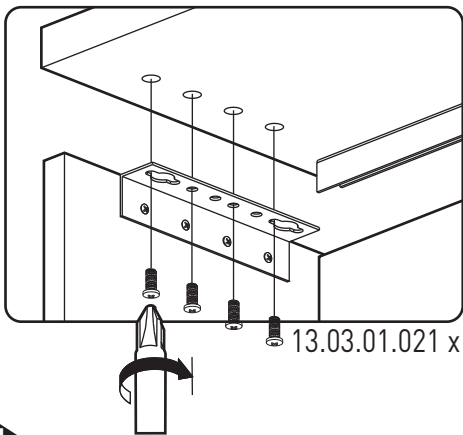

11

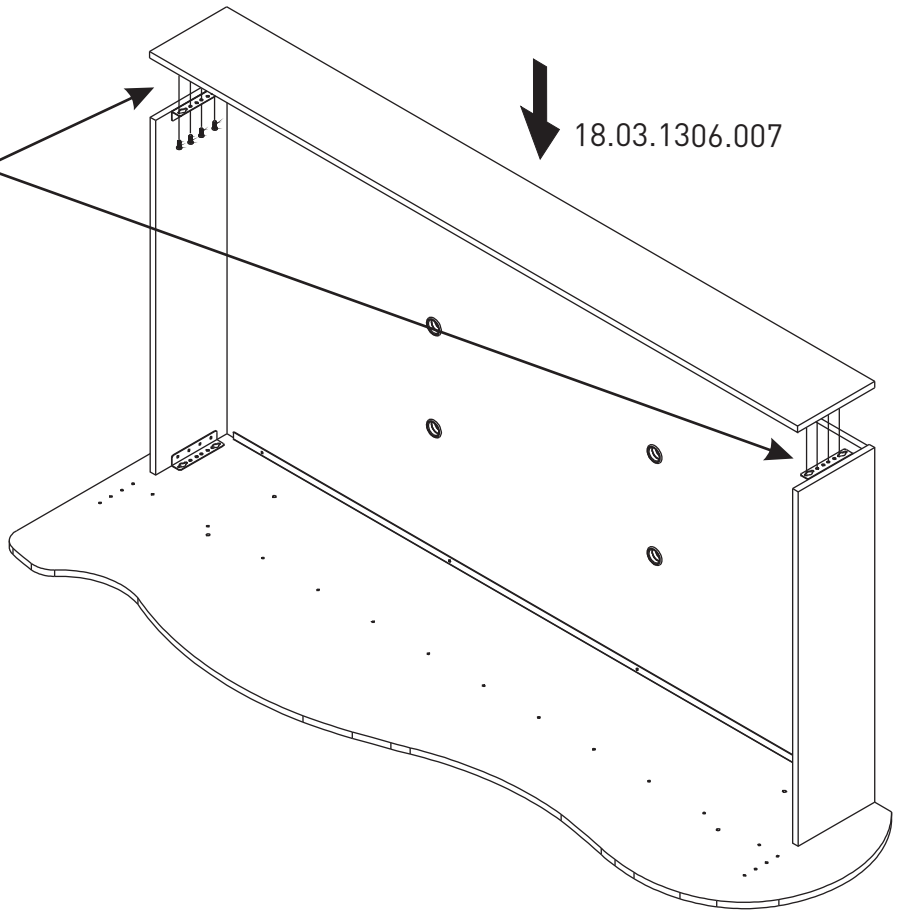
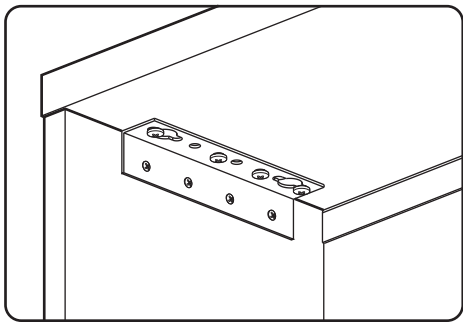

12

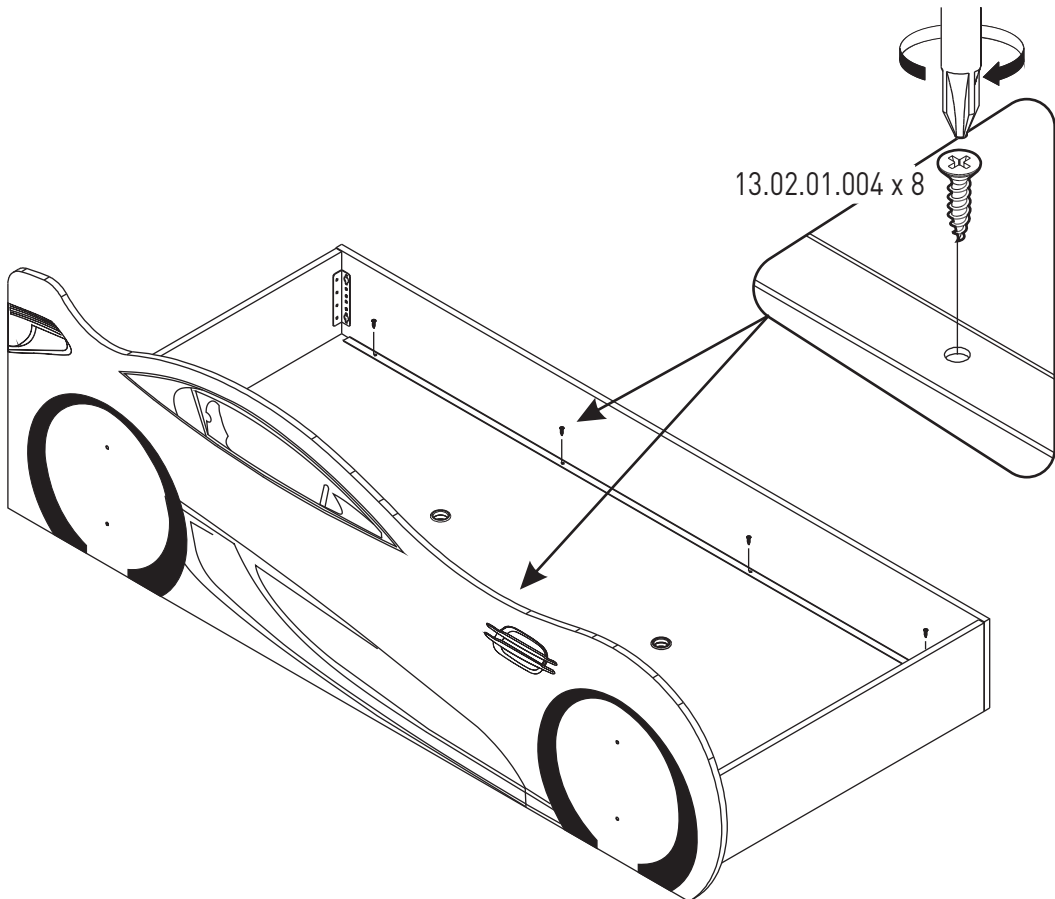

13

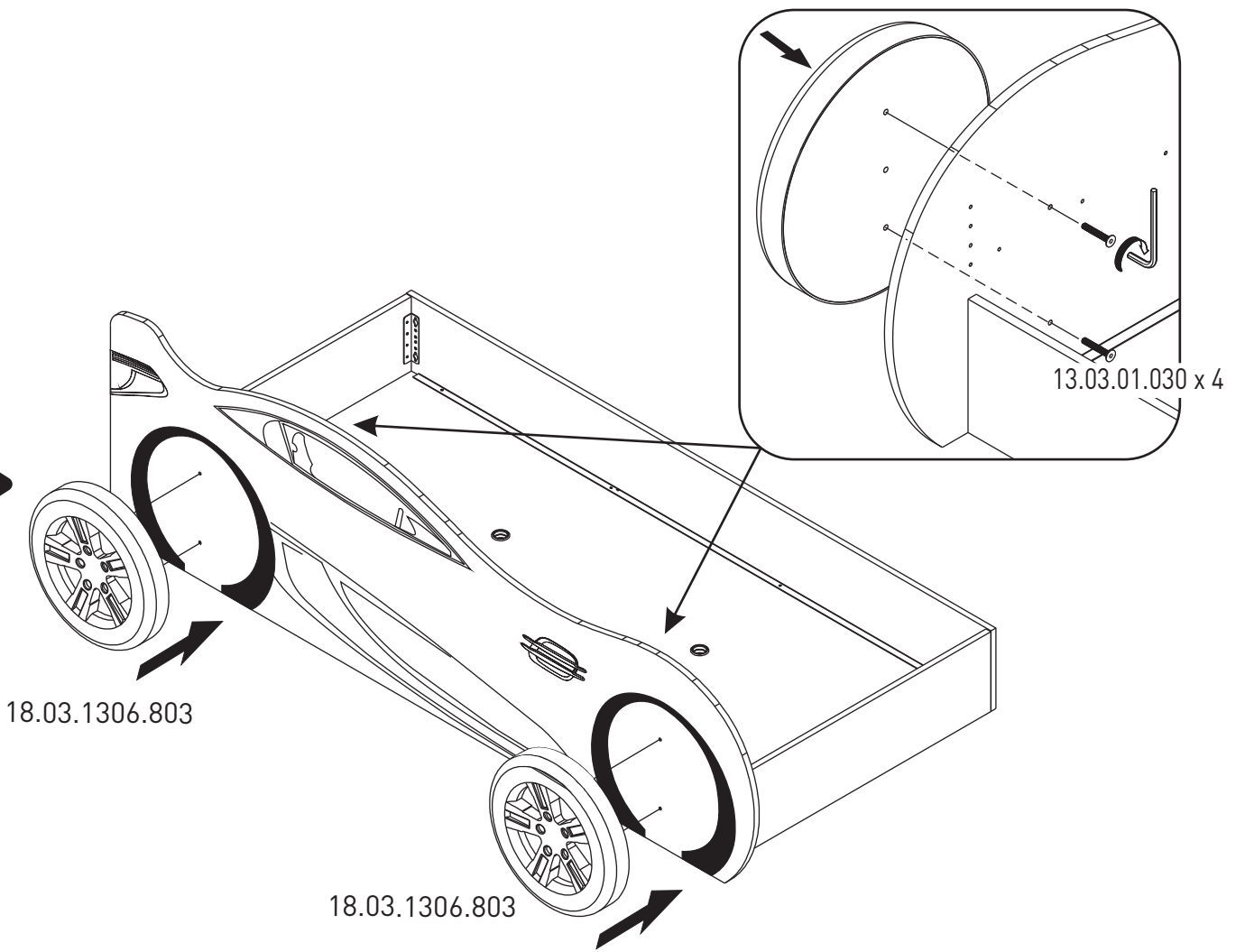

14

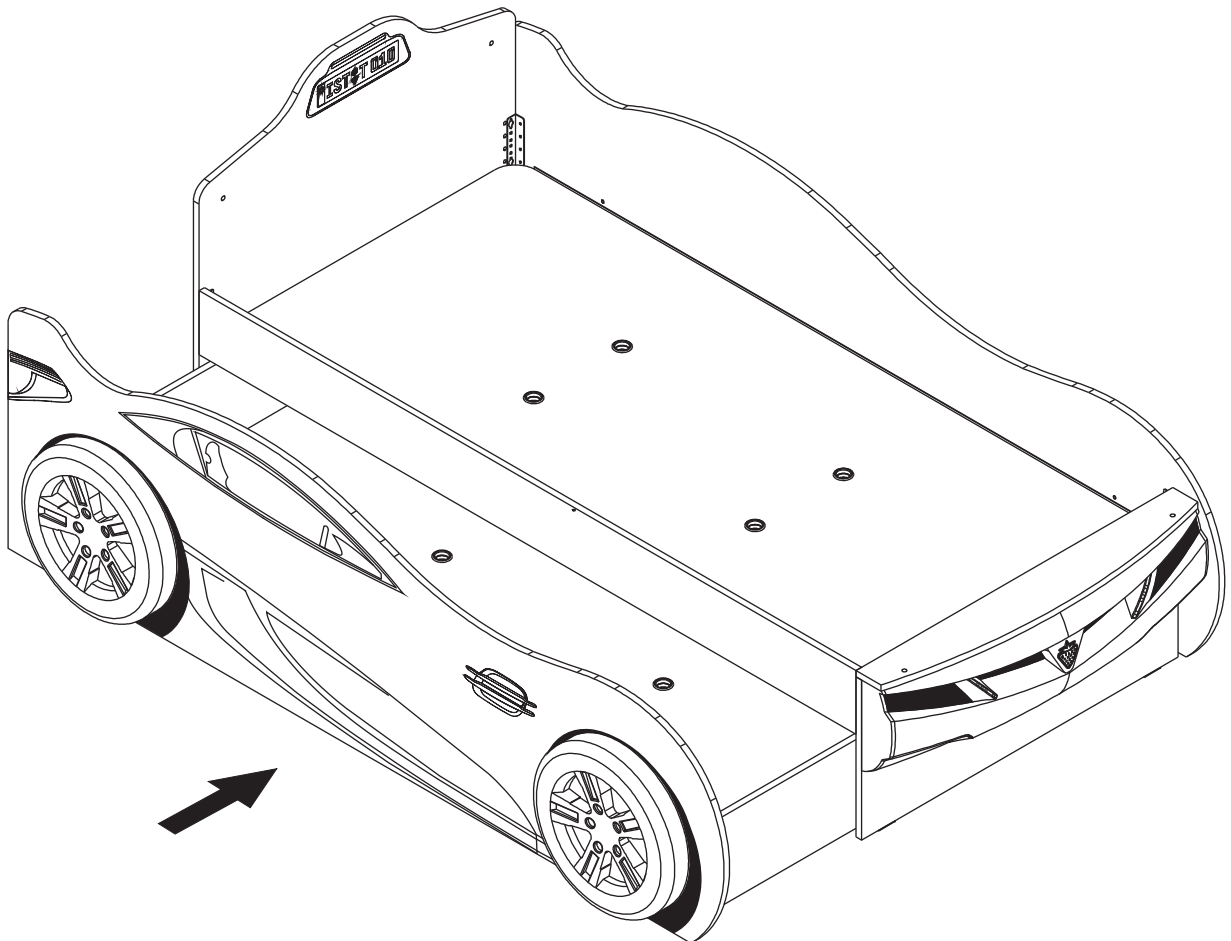

15

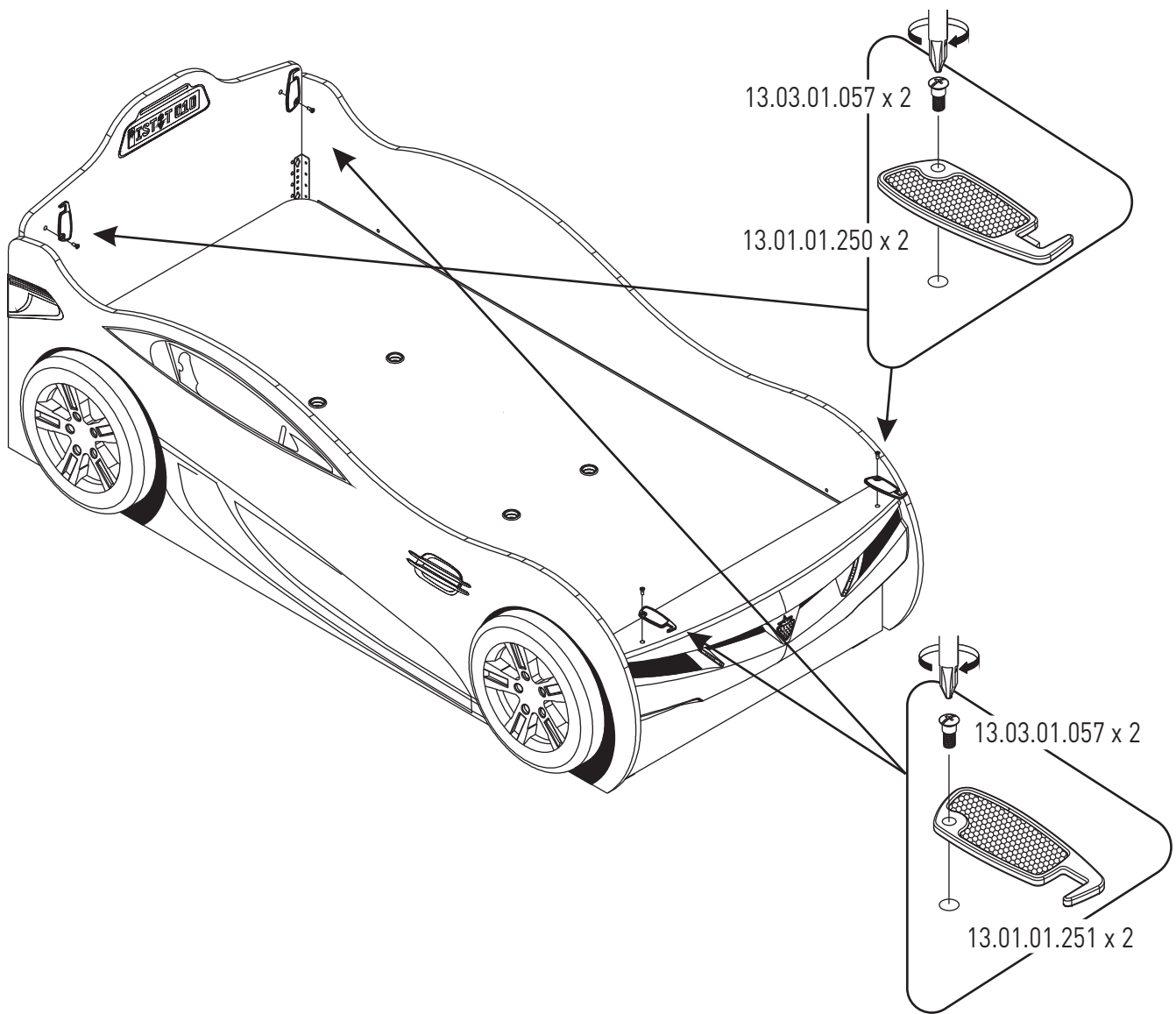

16

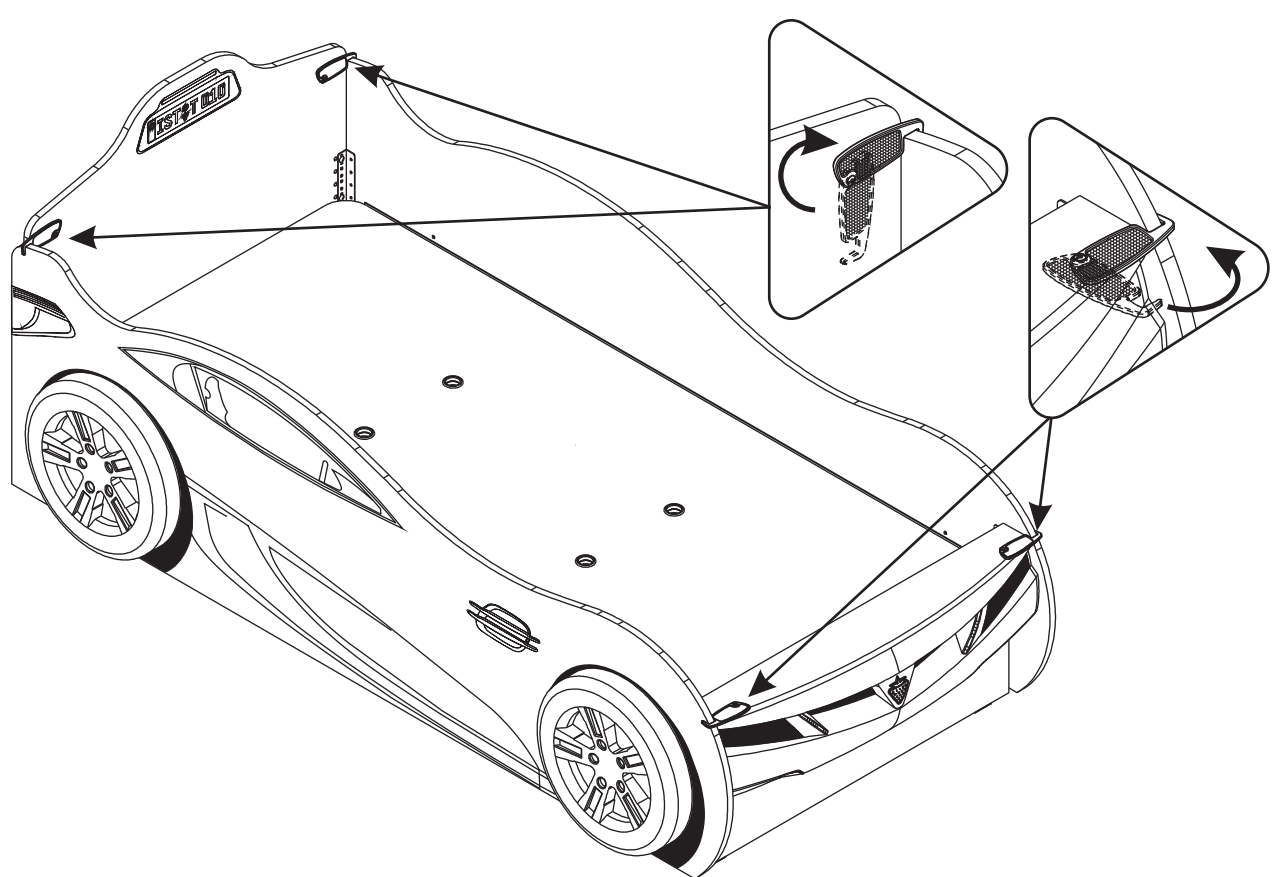

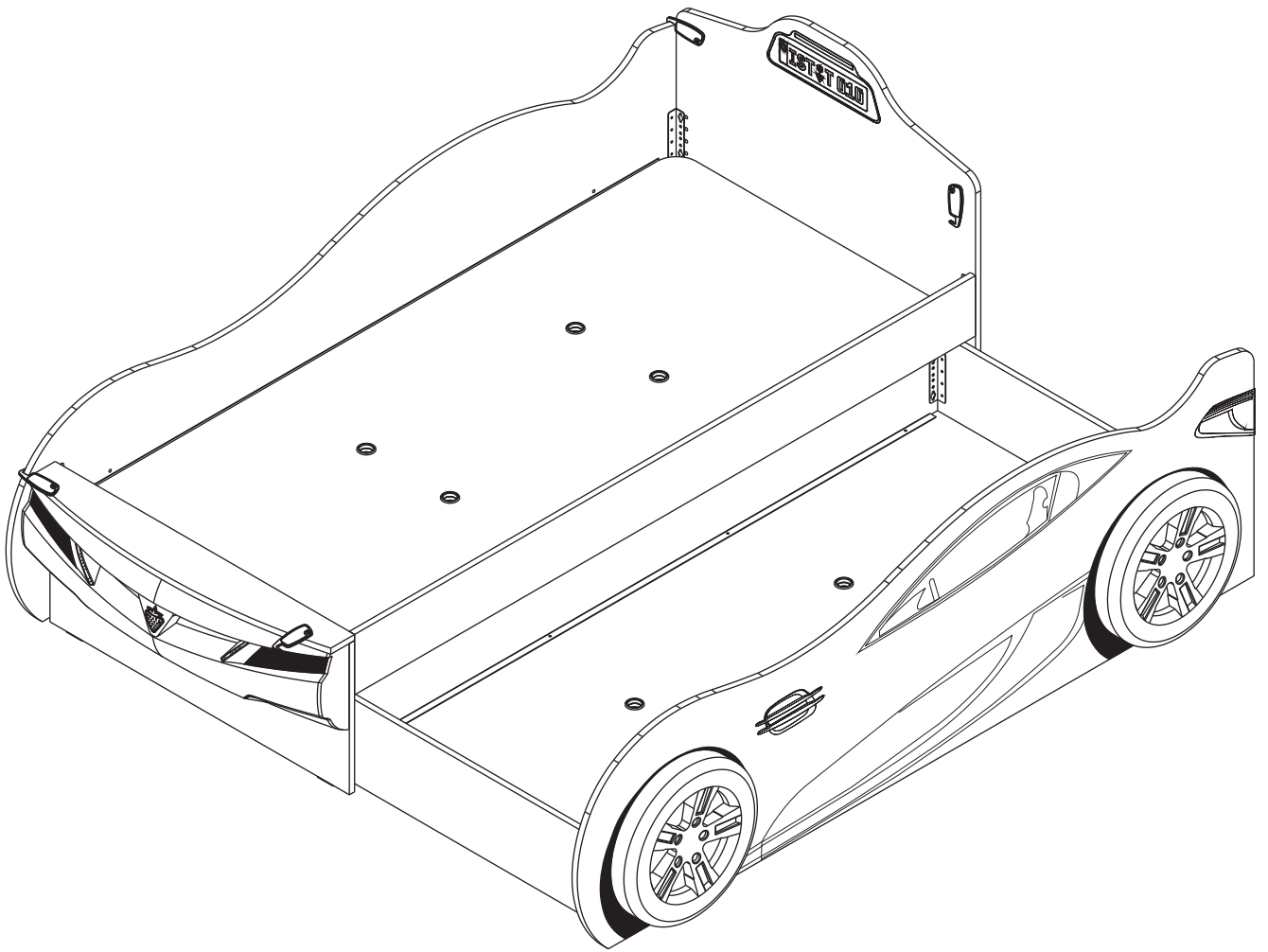

1

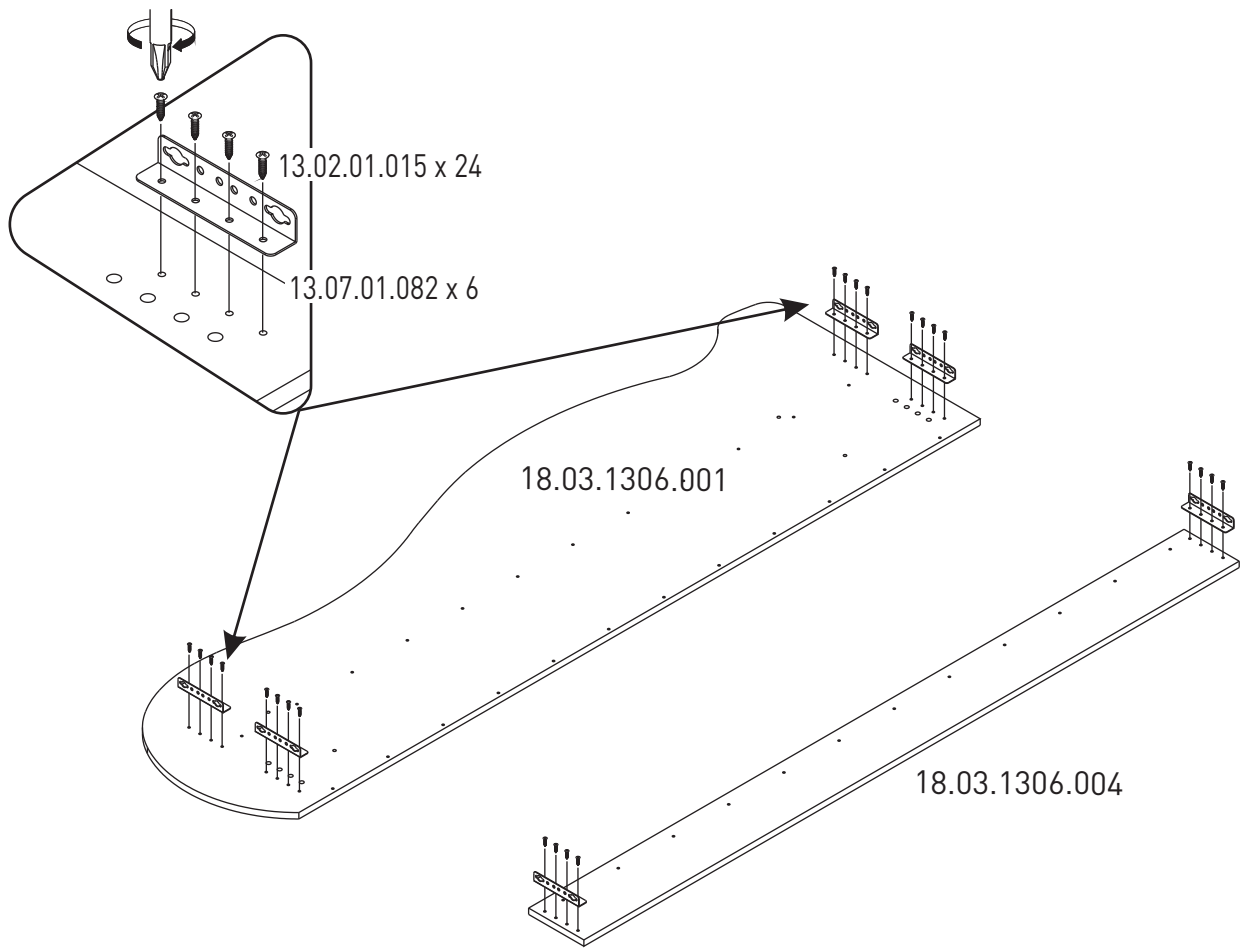

2

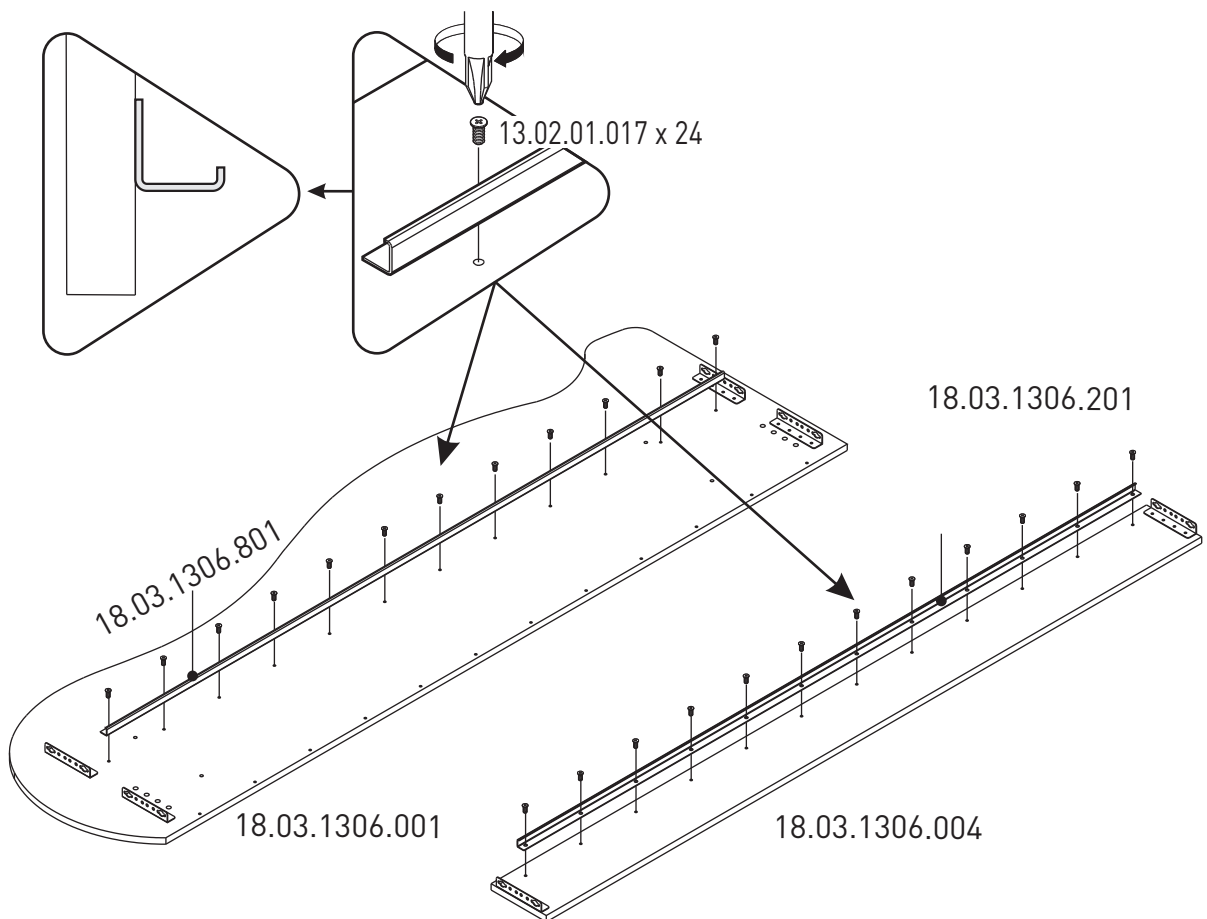

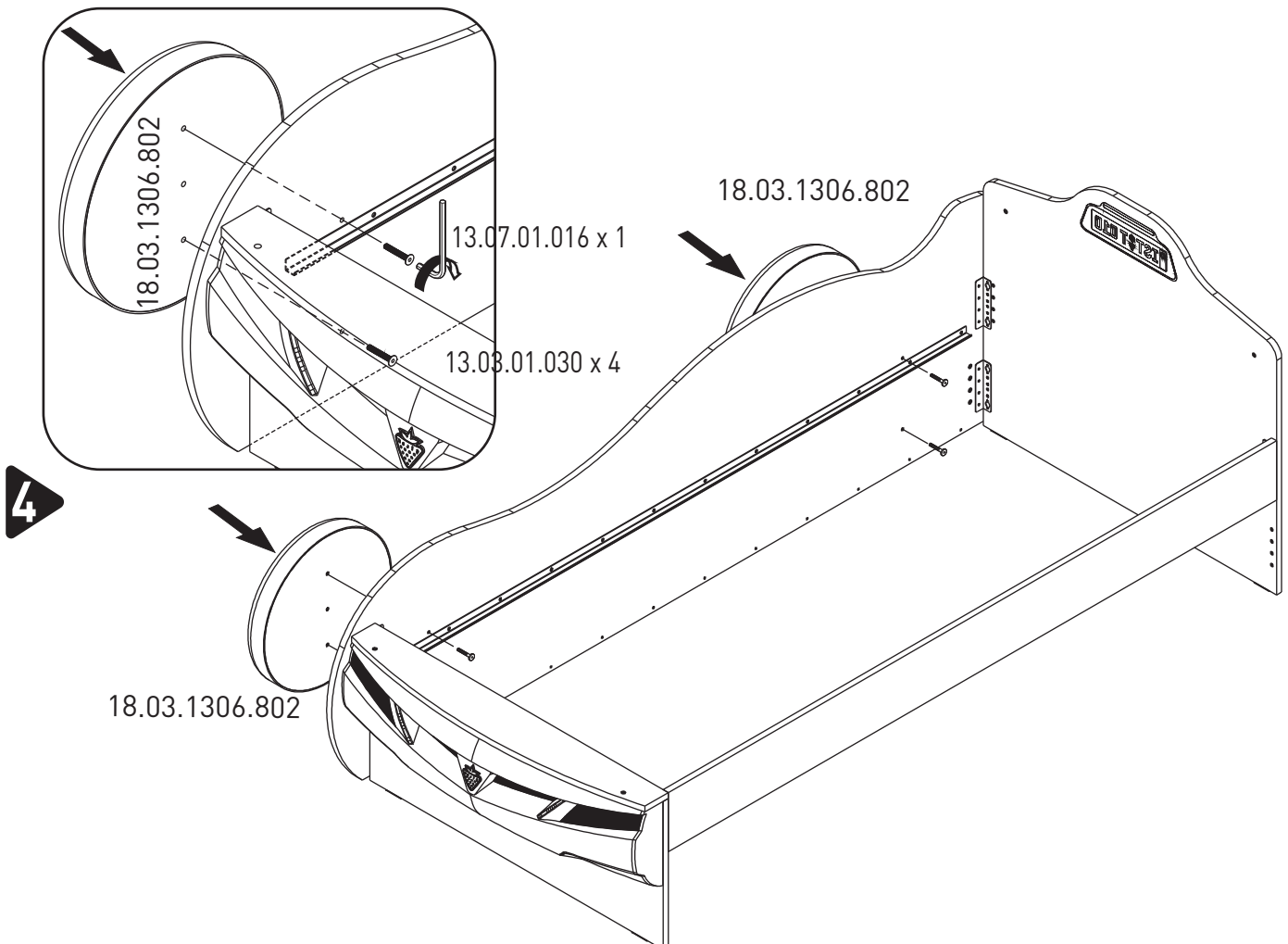
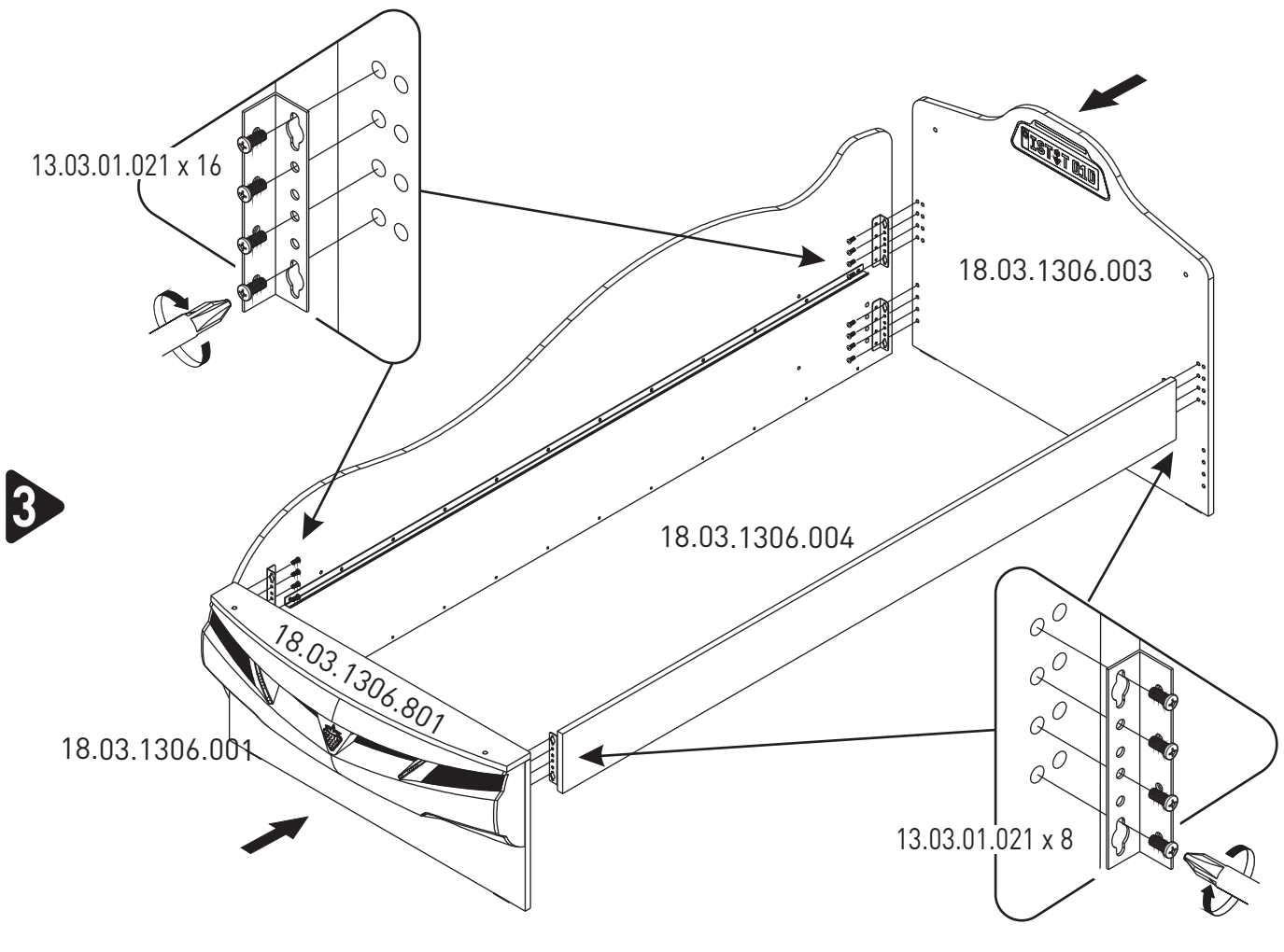

5

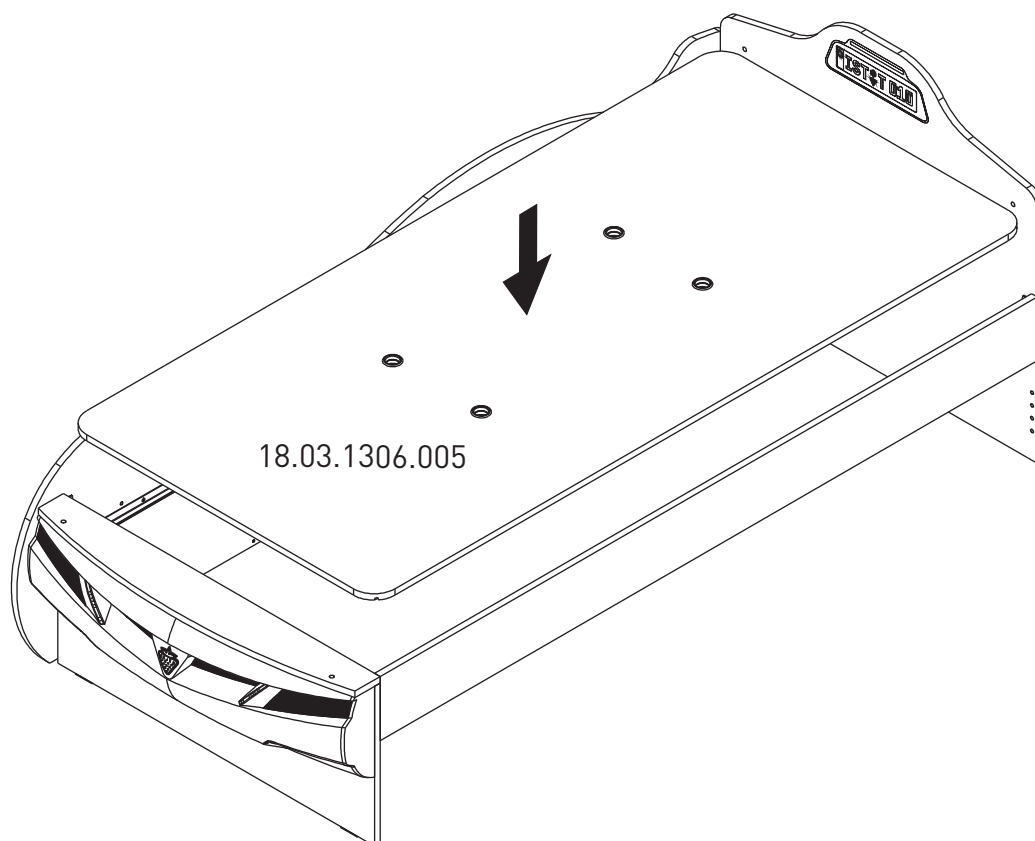

6

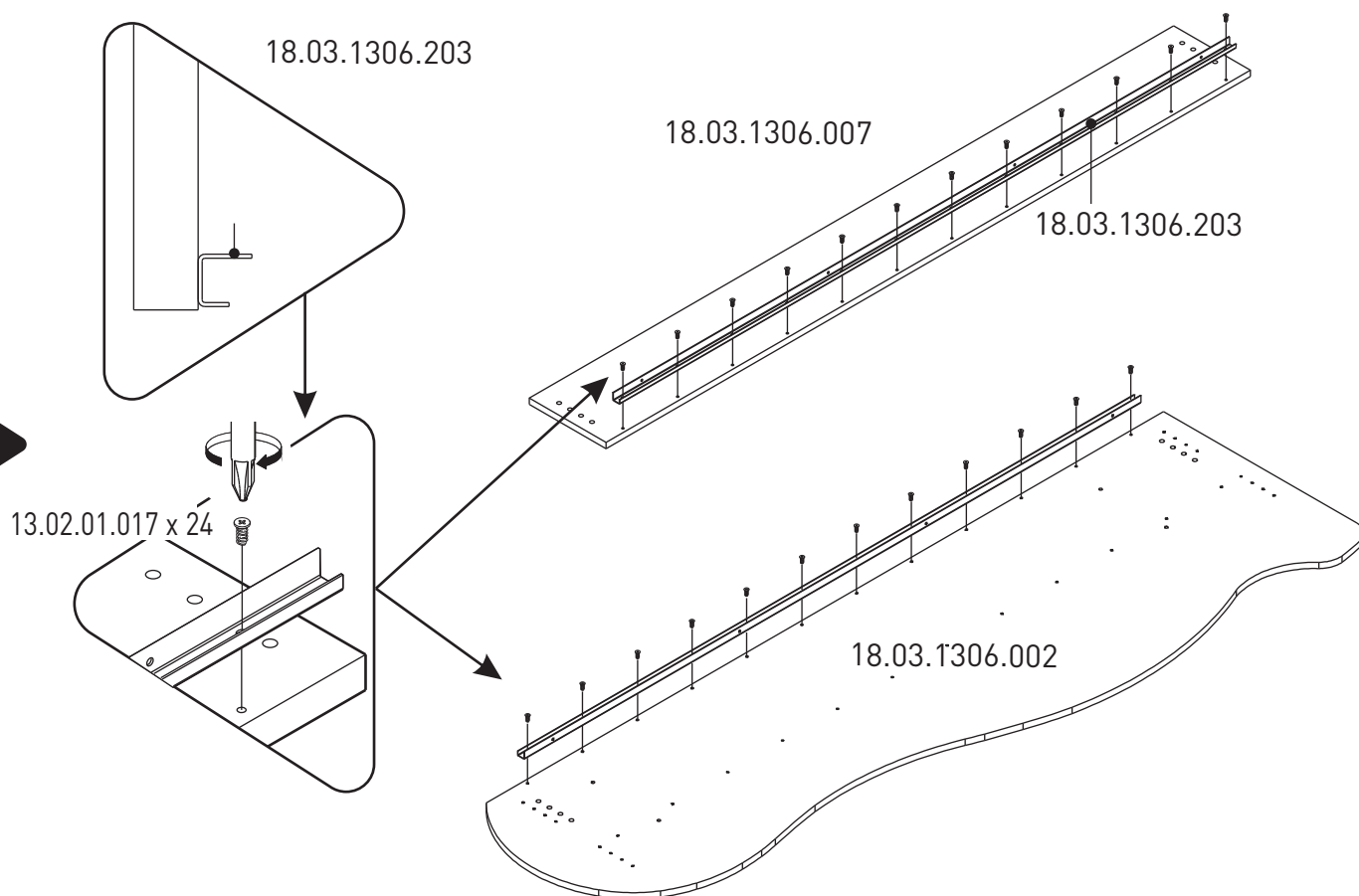

7

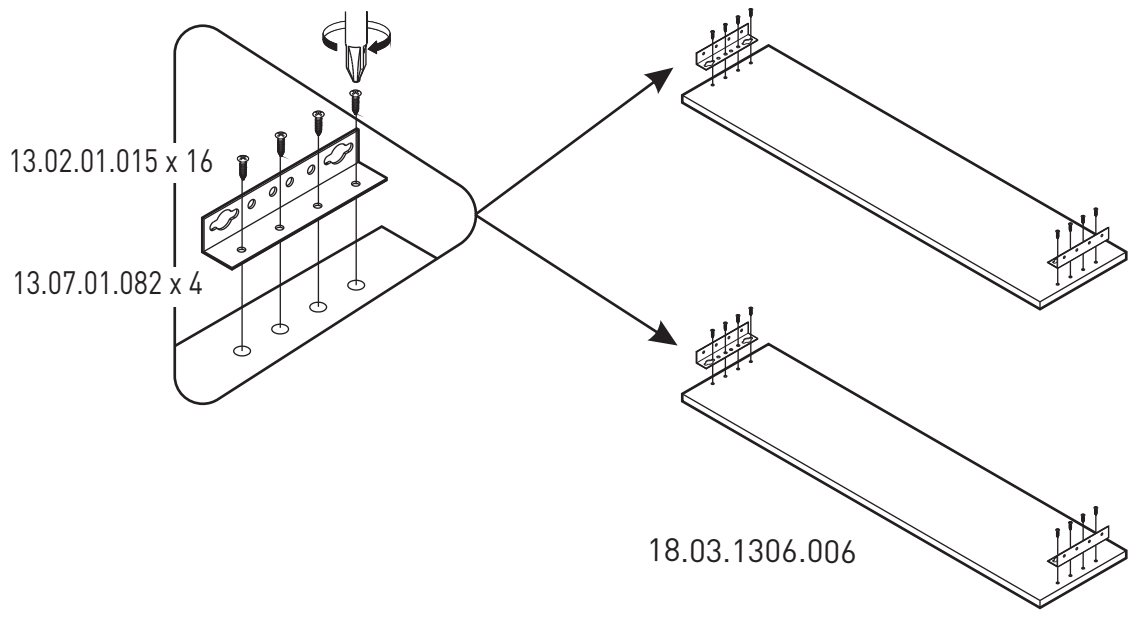

8

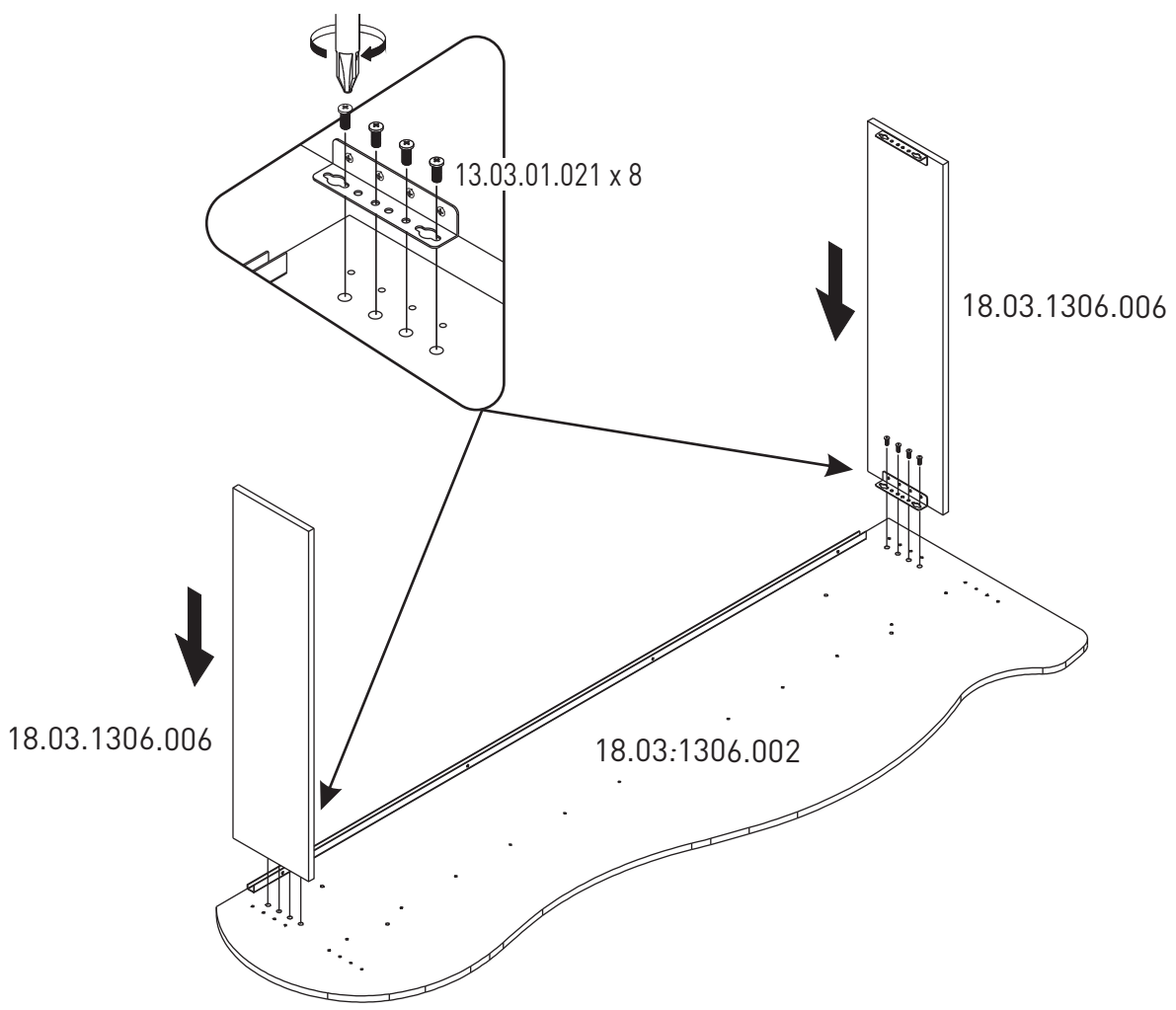



9

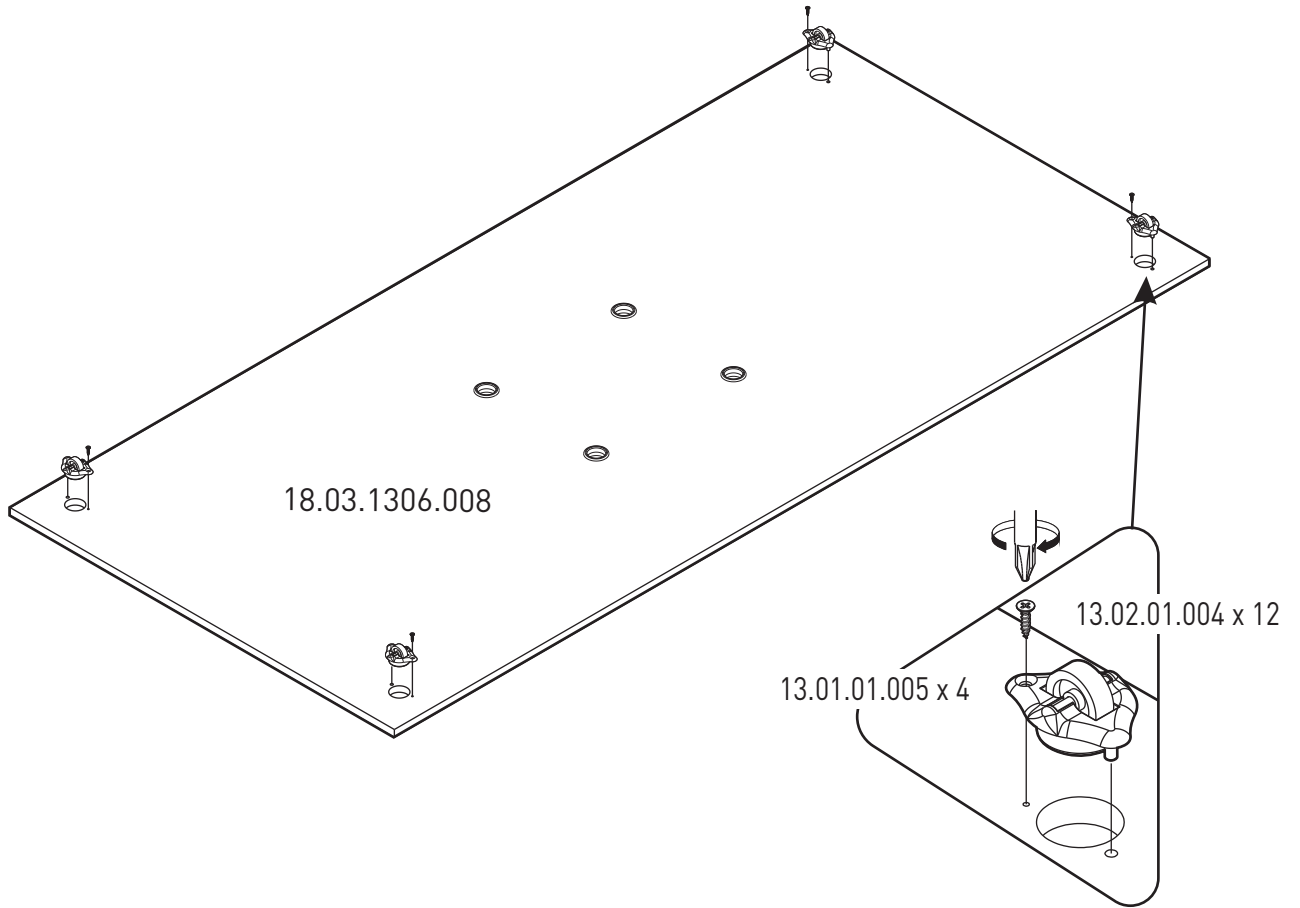

10

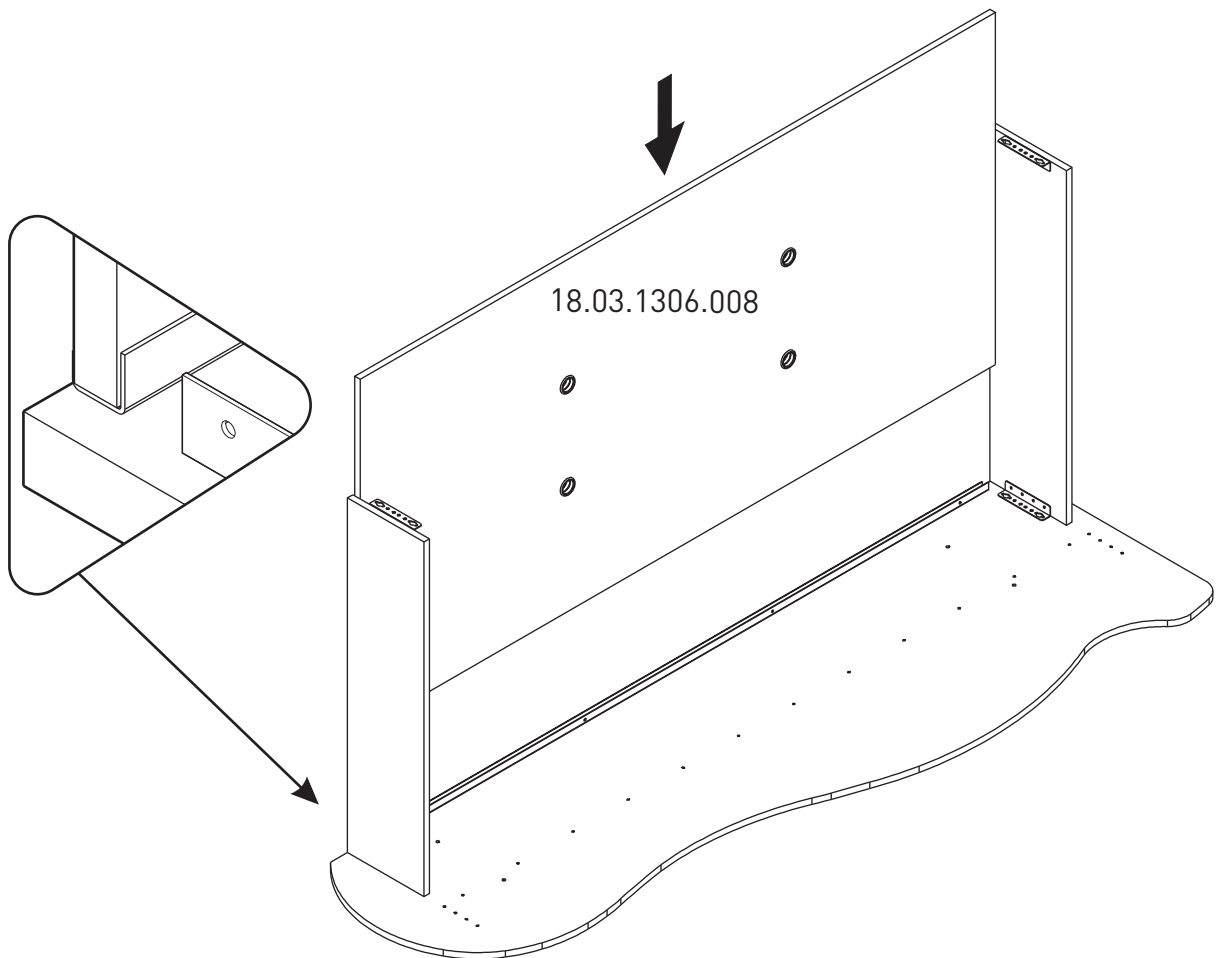

11

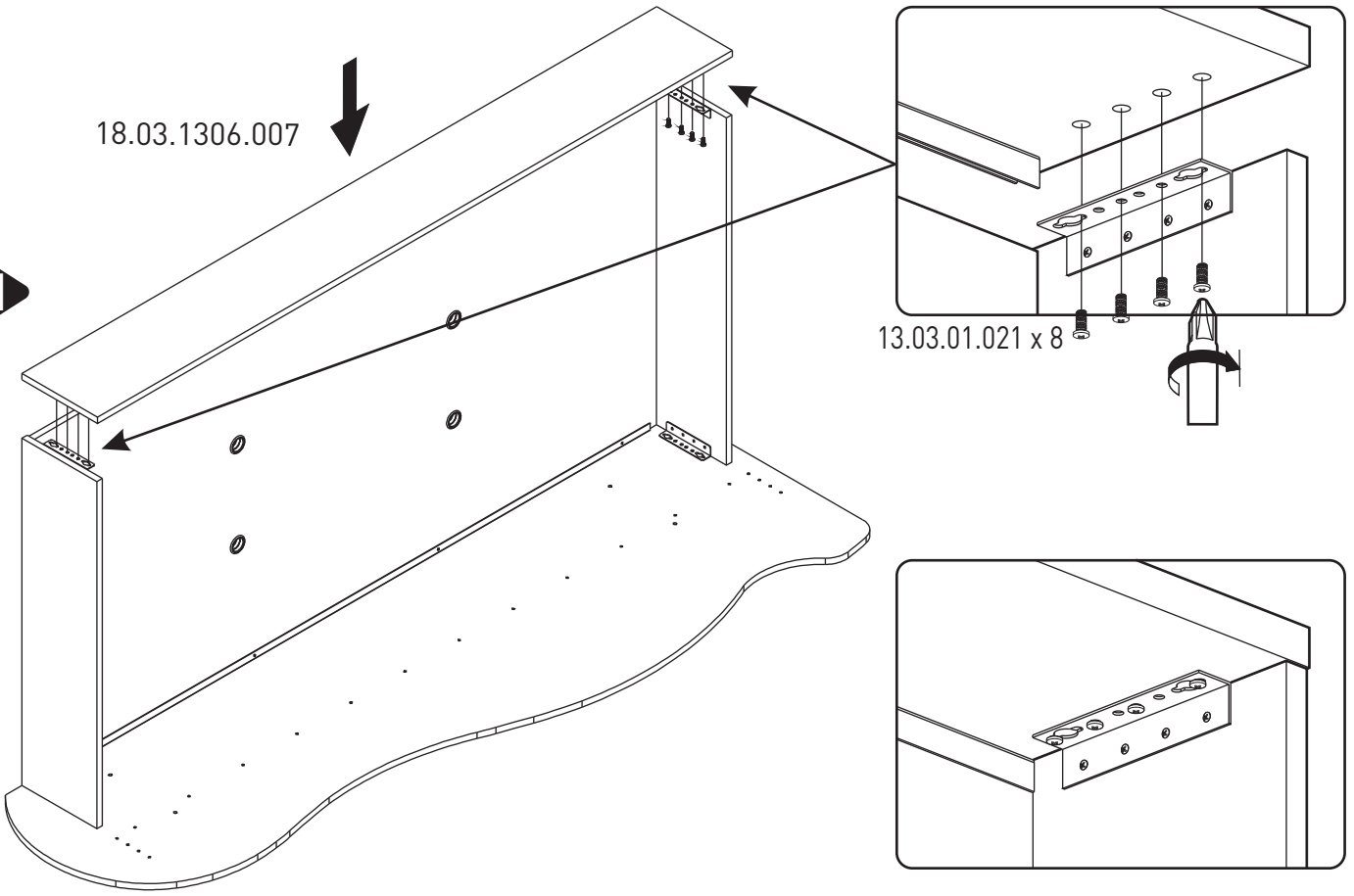

12

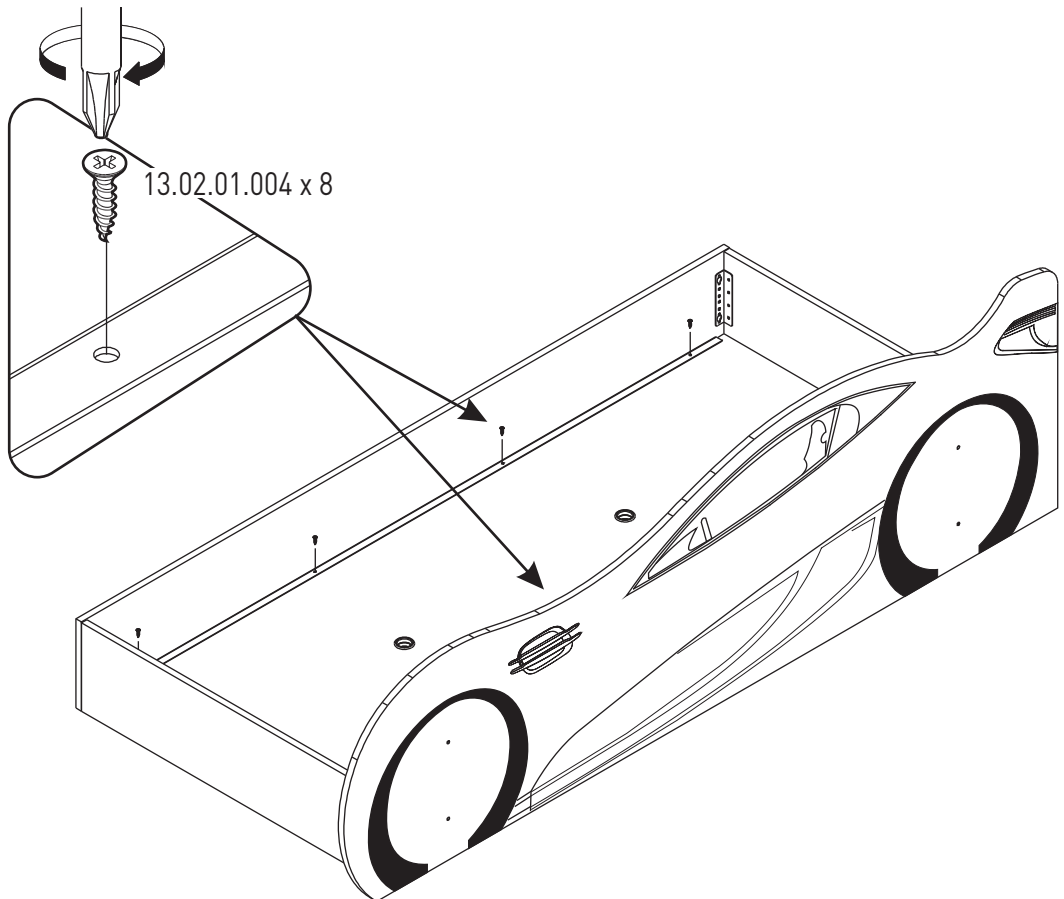

13

13.03.01.030 x 4

18.03.1306.803

18.03.1306.002

18.03.1306.803

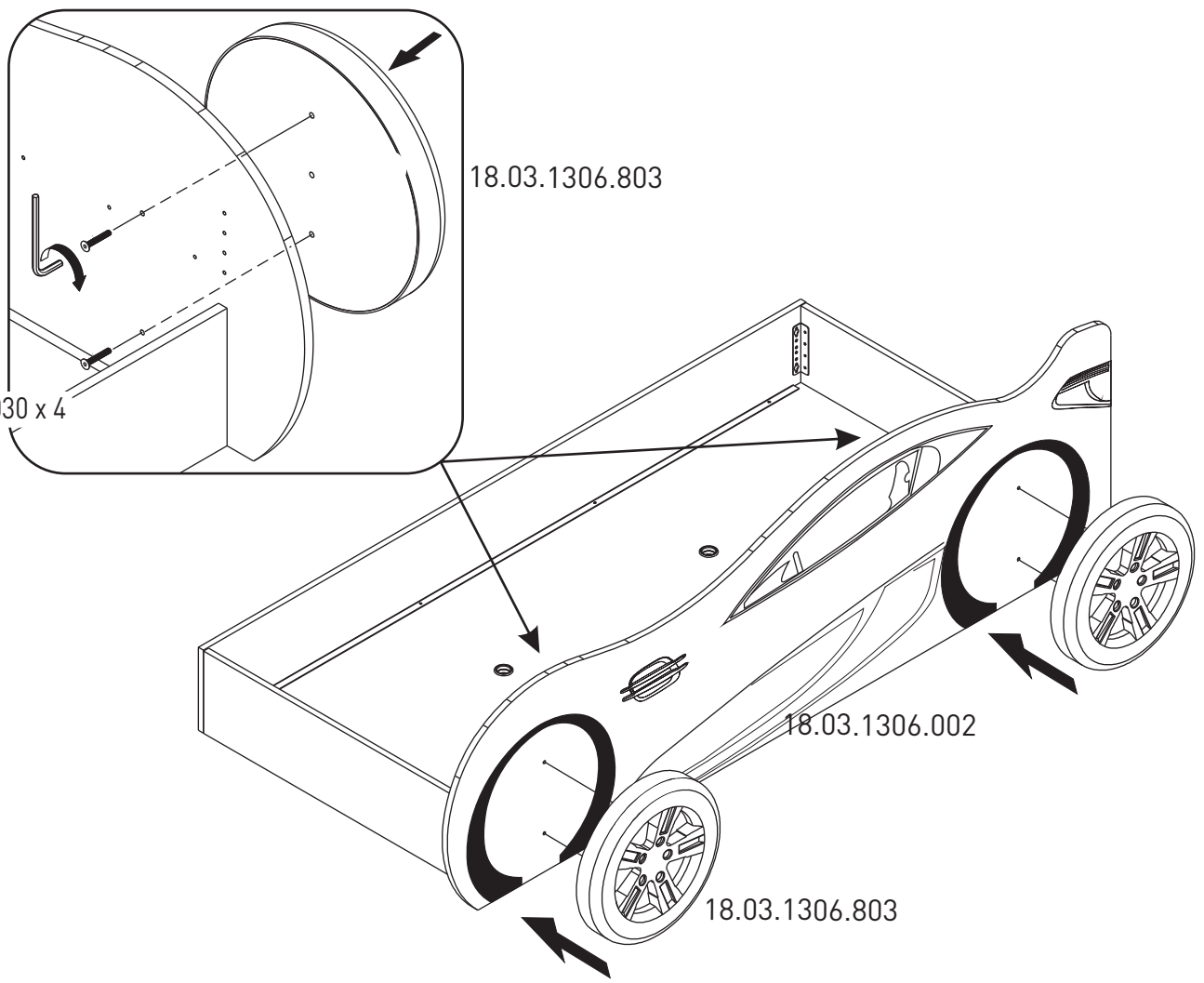

14

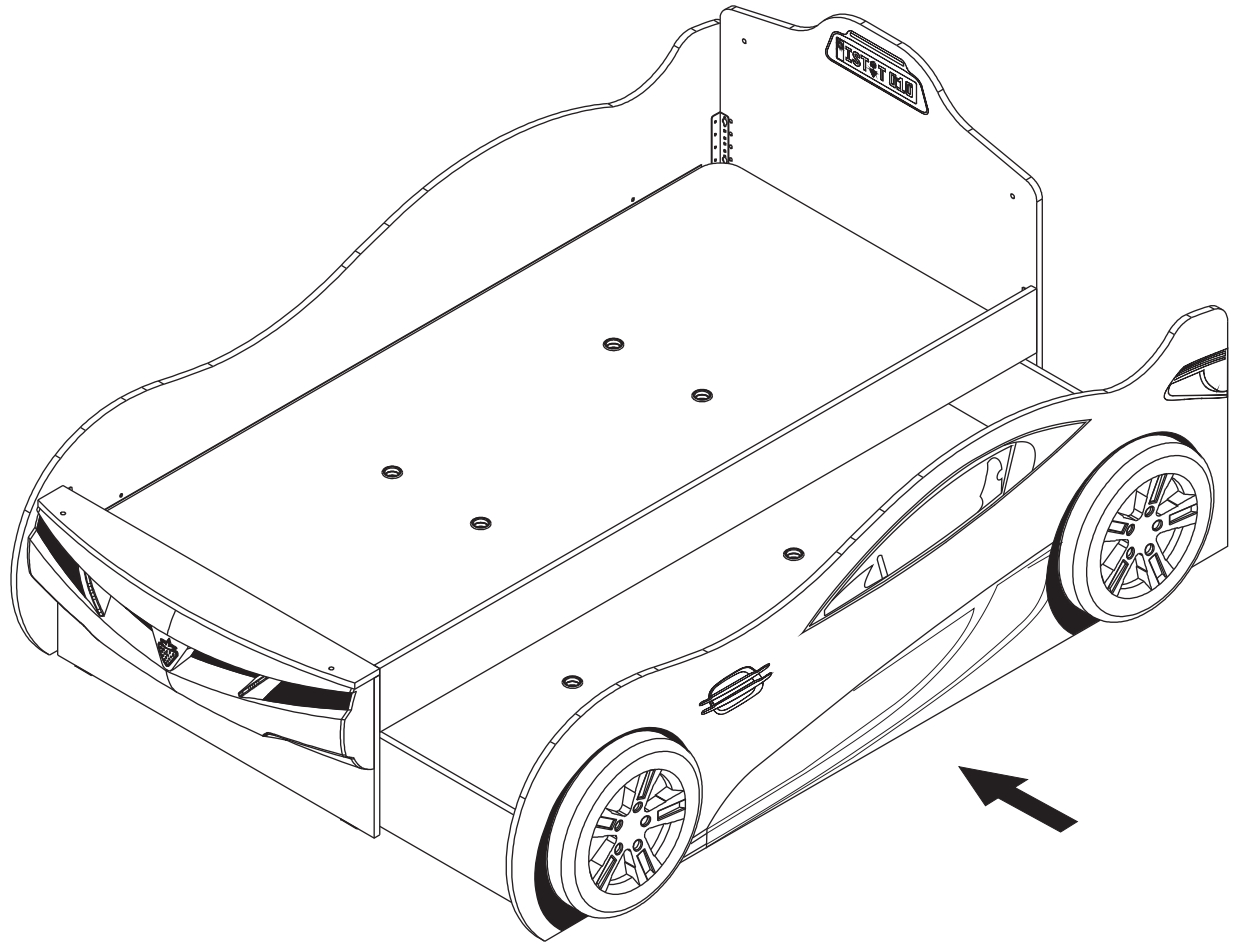

15

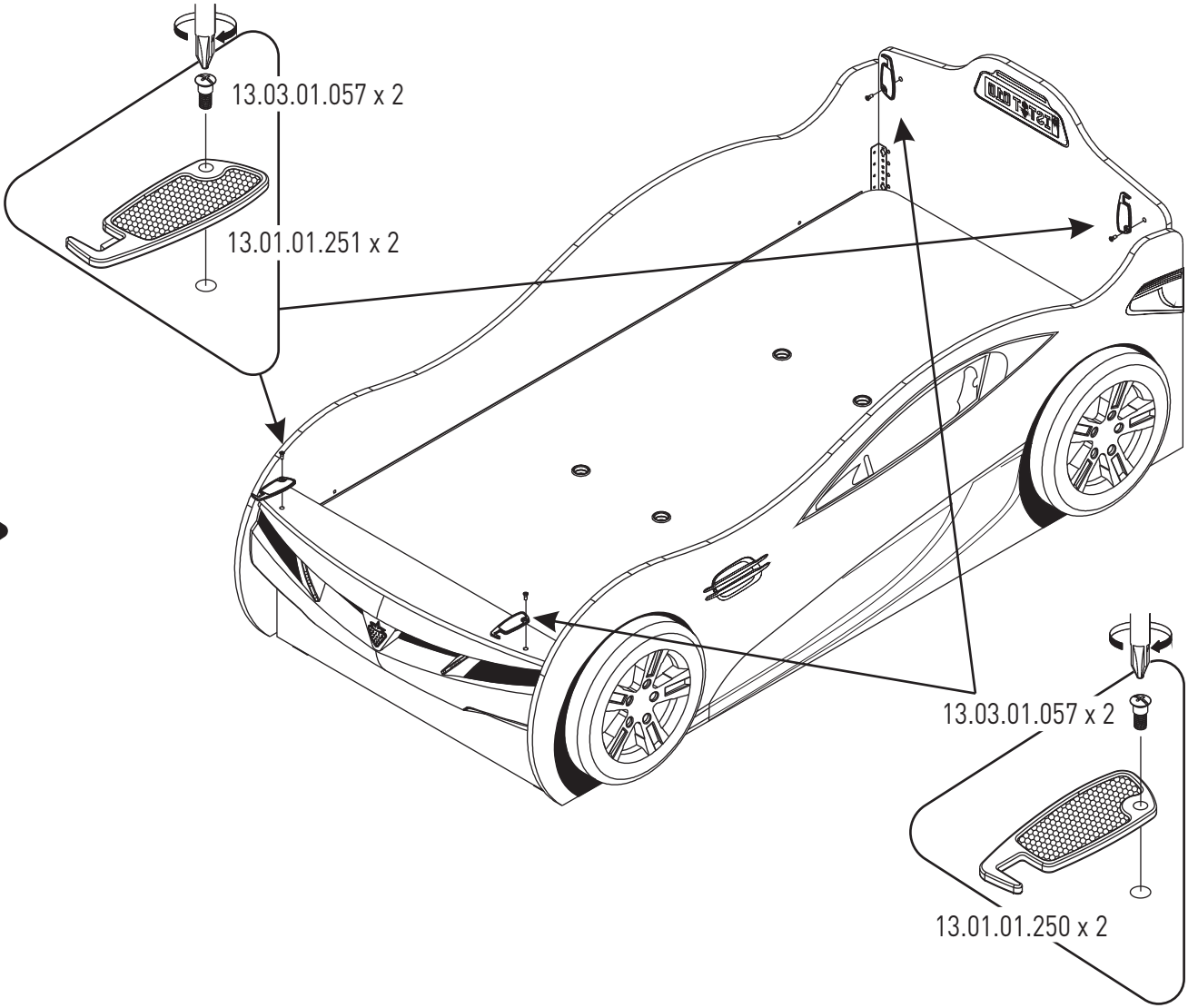

16

