

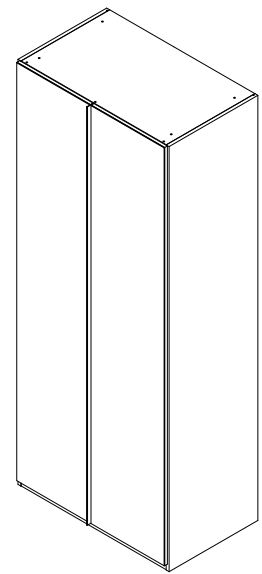

IMPORTANT - READ CAREFULLY - RETAIN FOR FUTURE REFERENCE
WICHTIG - SORGFÄLTIG LESEN UND AUFBEWAHREN

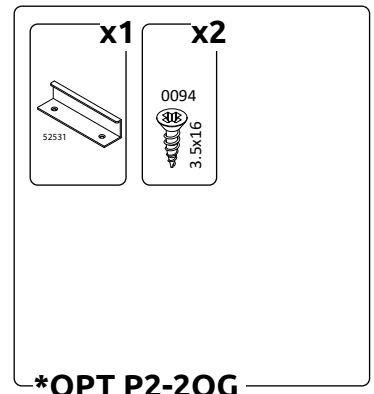

P2-2OG/AV
LWH - 918x555x2236

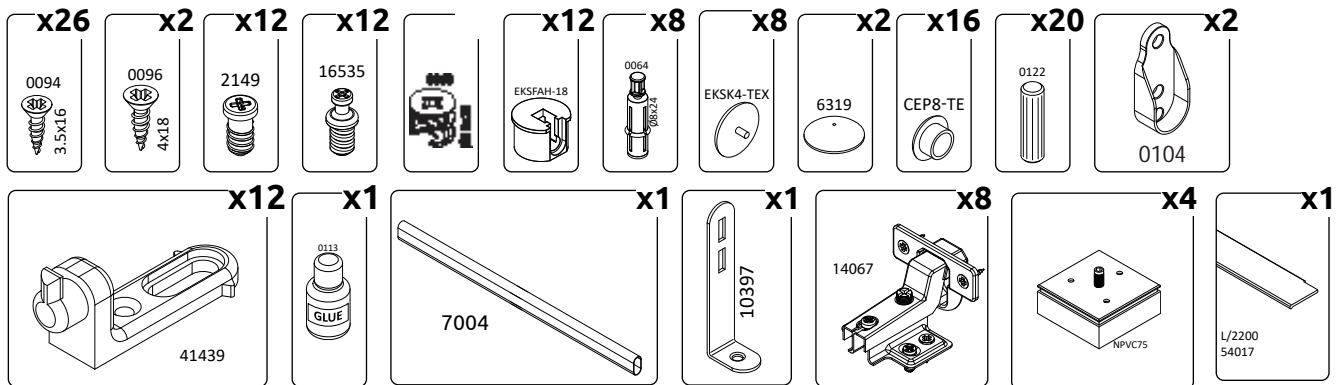
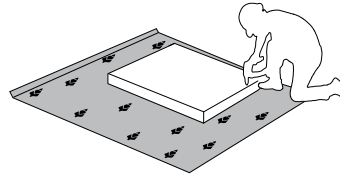
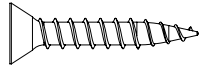
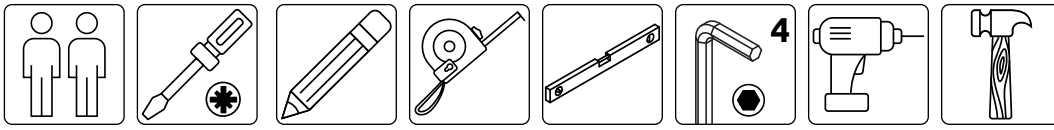
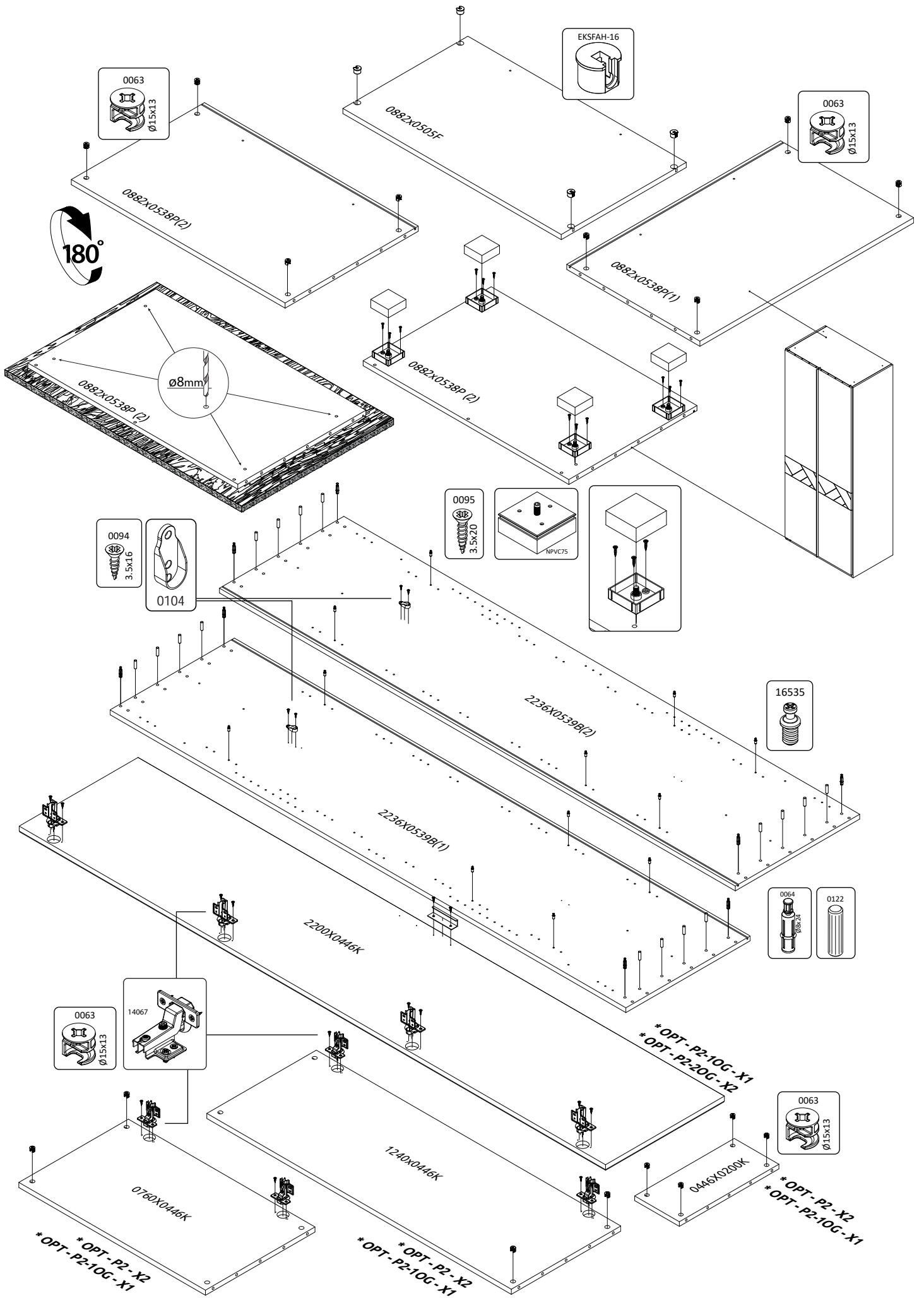

1

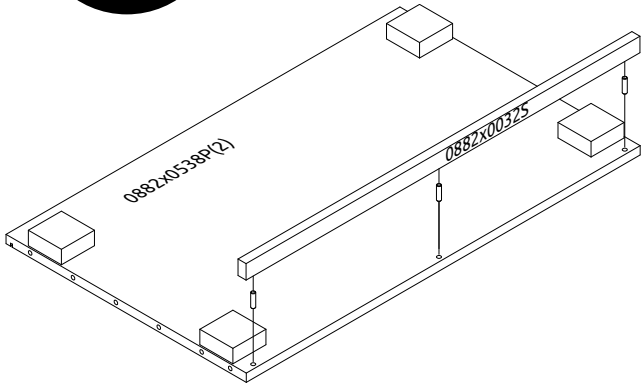
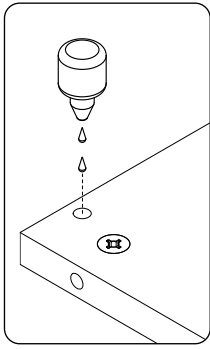
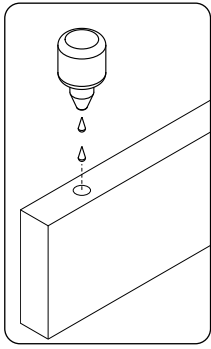
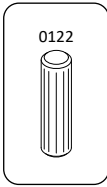

2

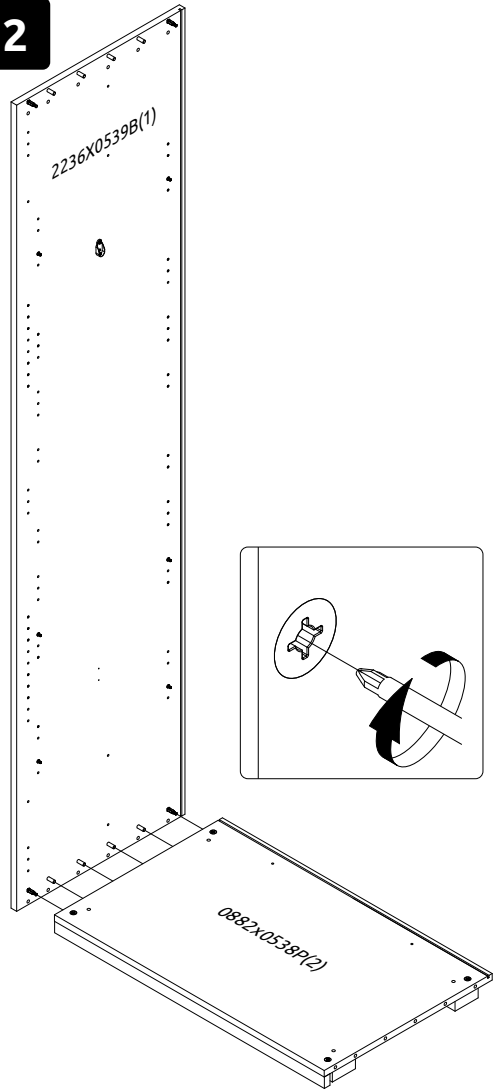

3

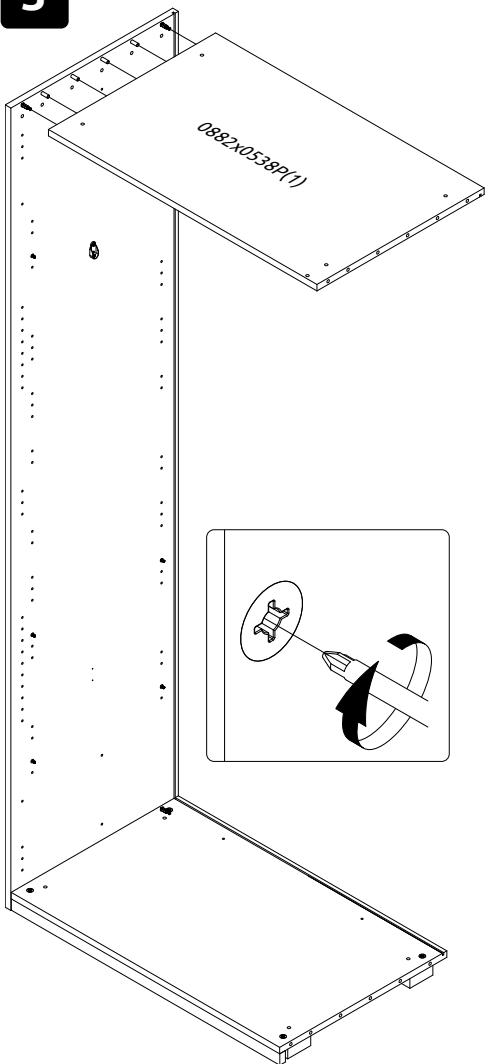

4

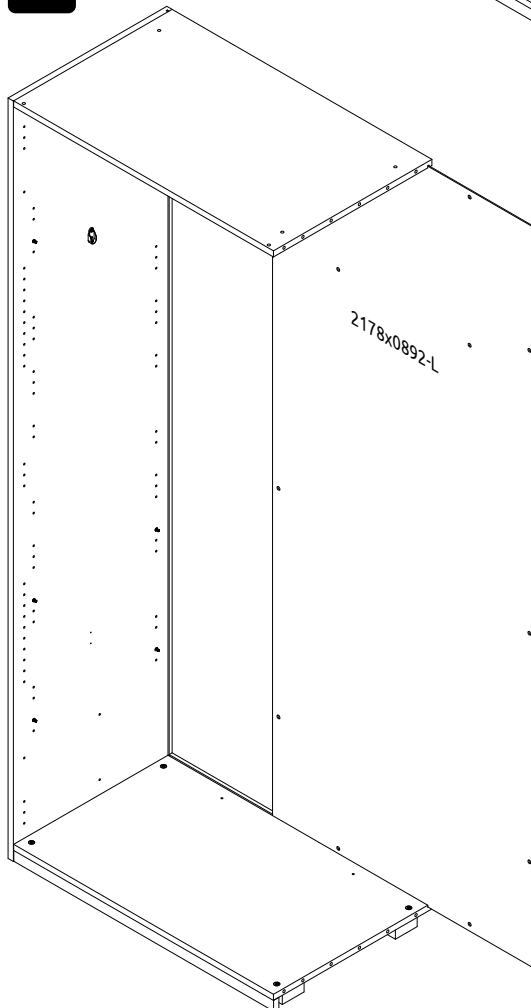

5



*opt 1

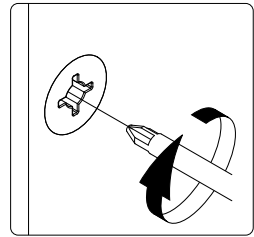
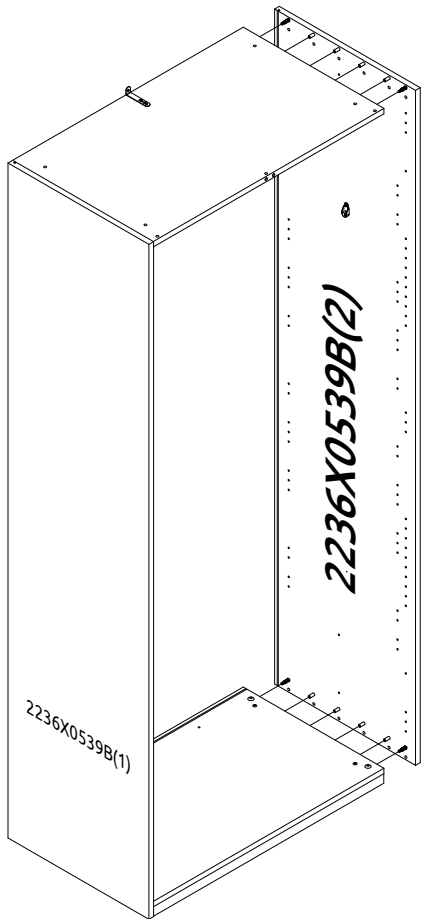
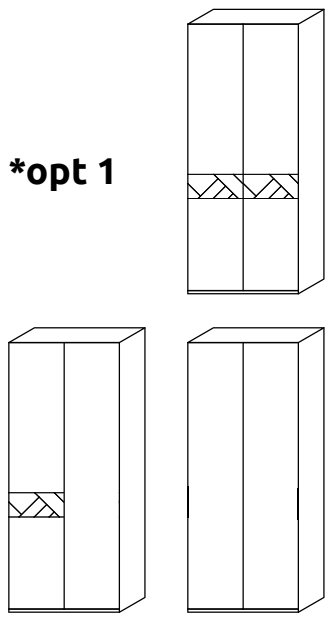

*opt 2

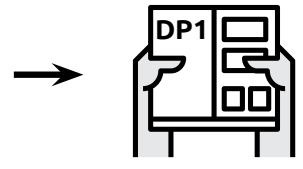
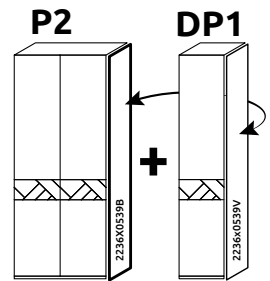

*opt 3

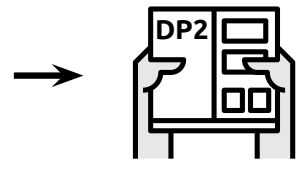
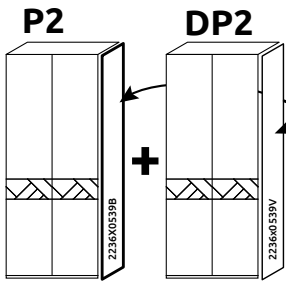

*opt 4

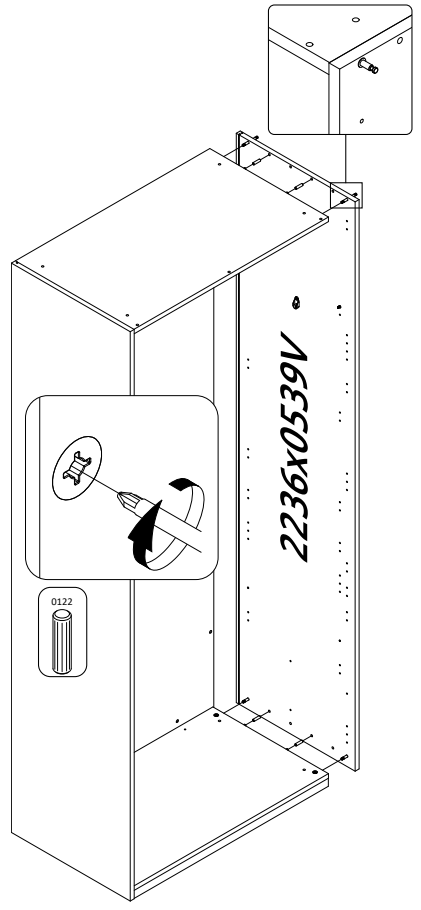
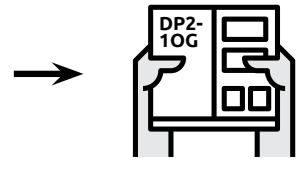
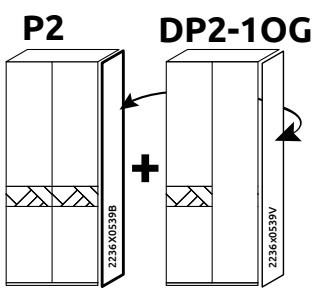

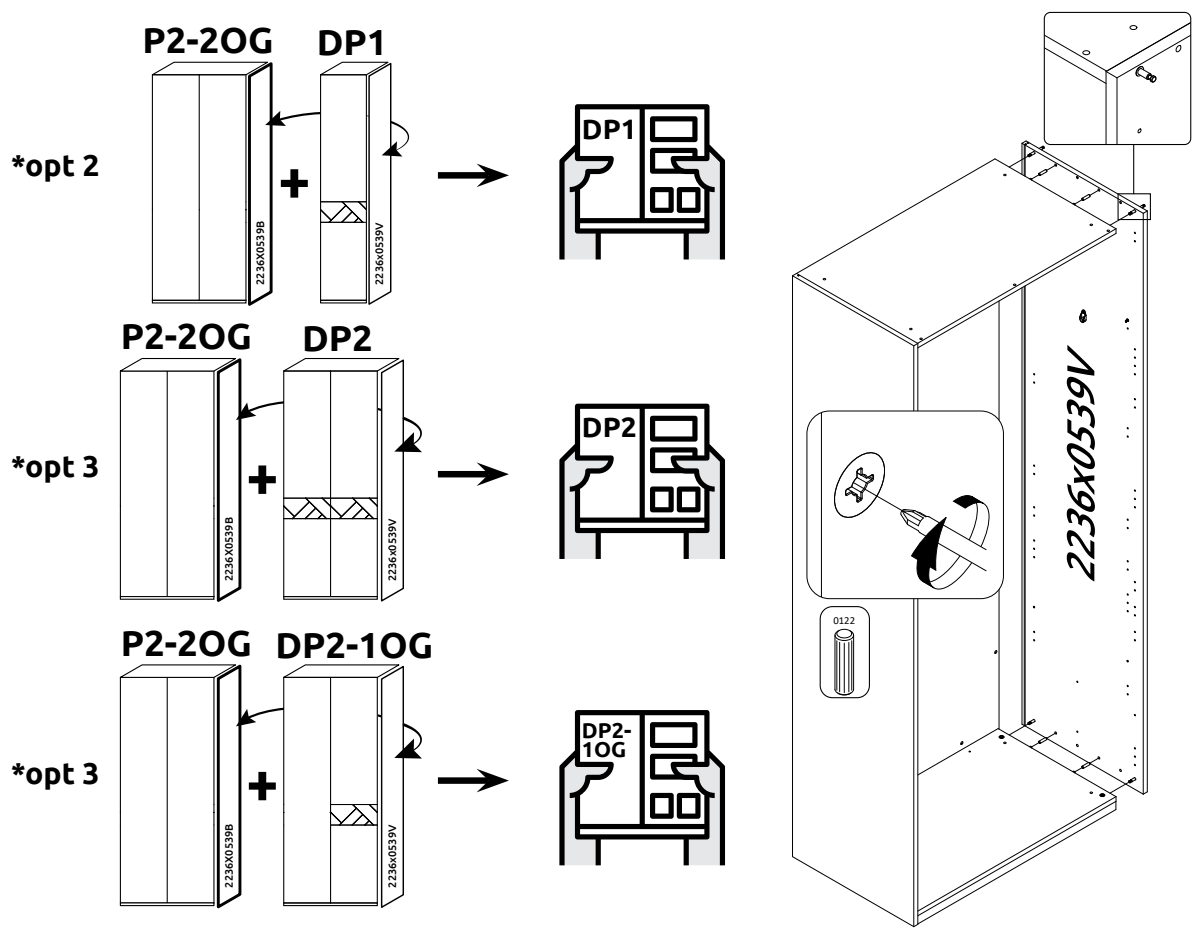
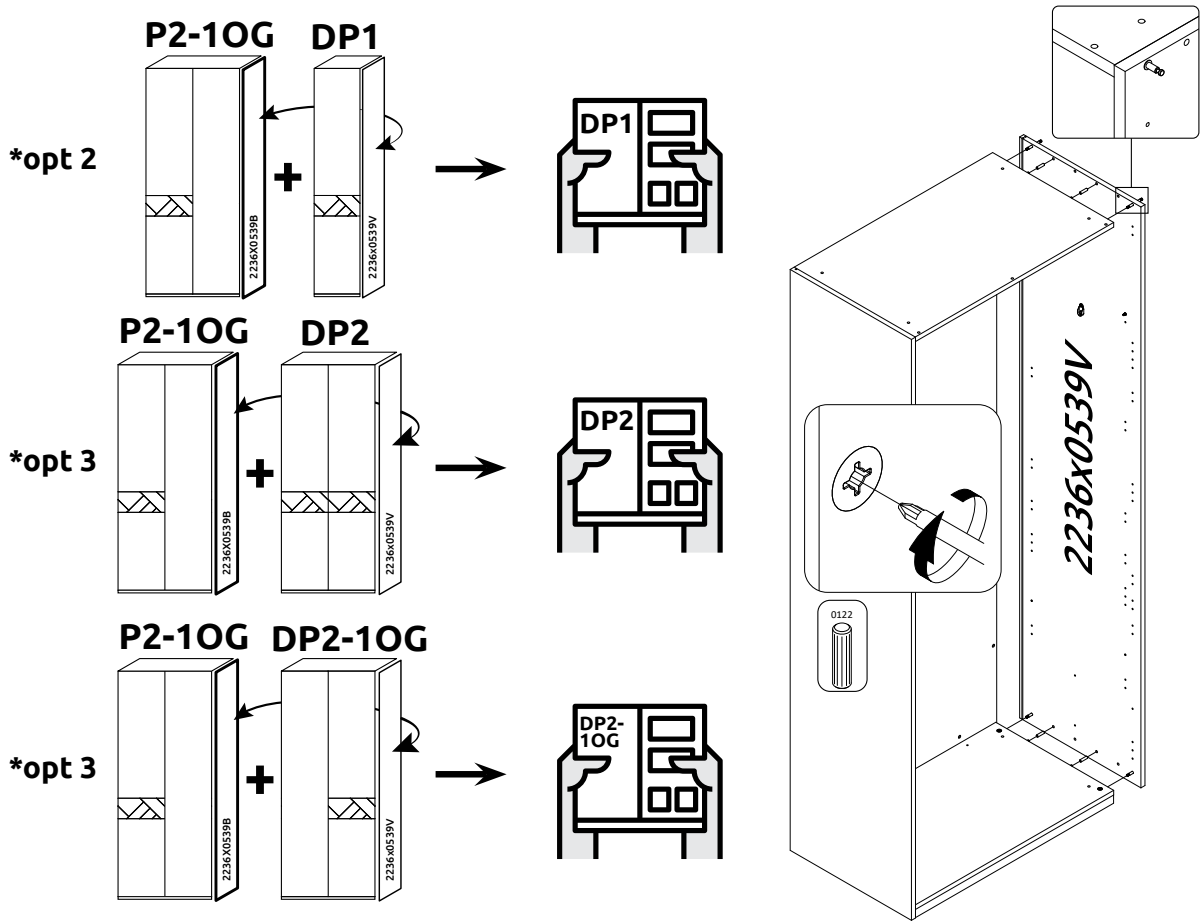

6

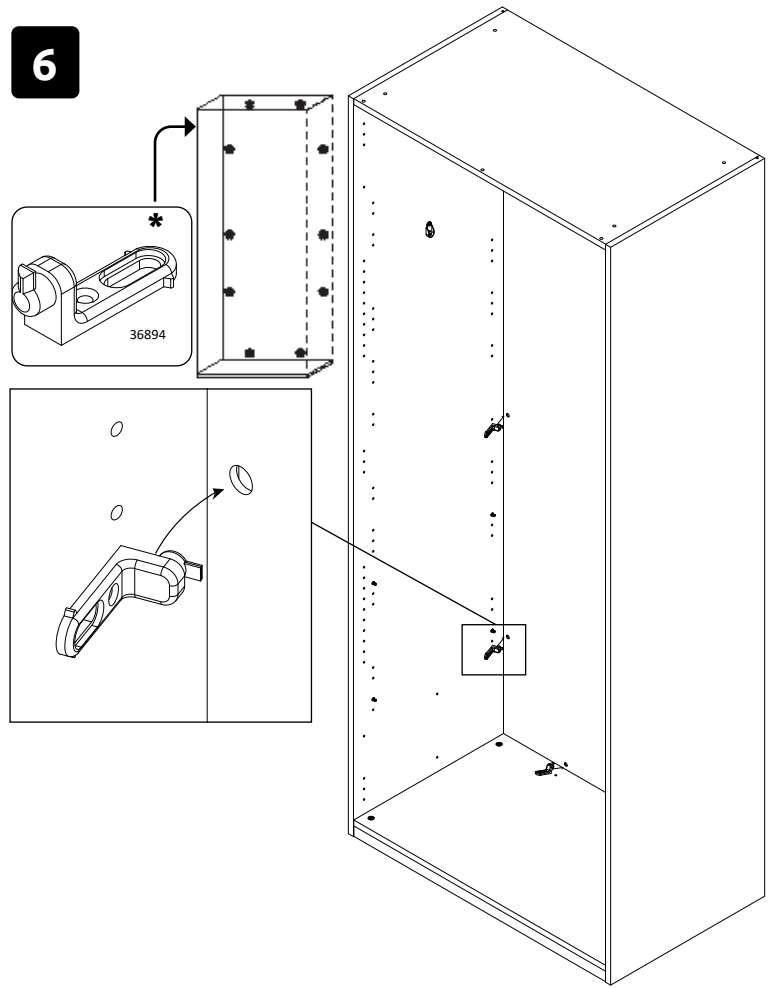

7

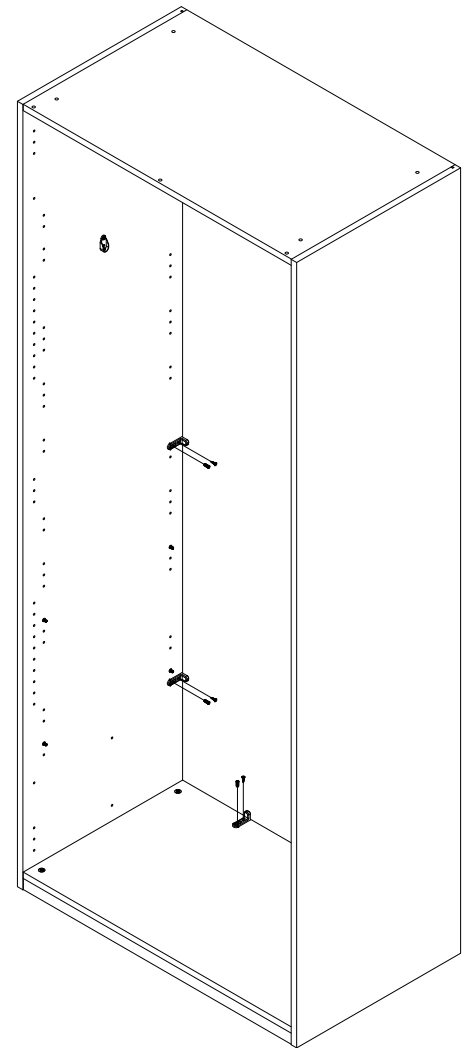
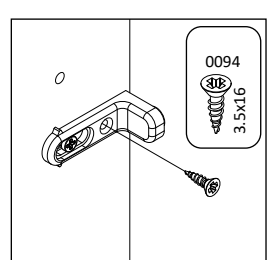
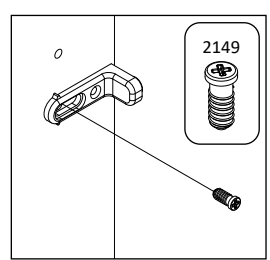
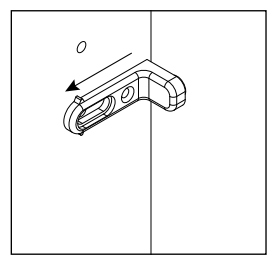

8

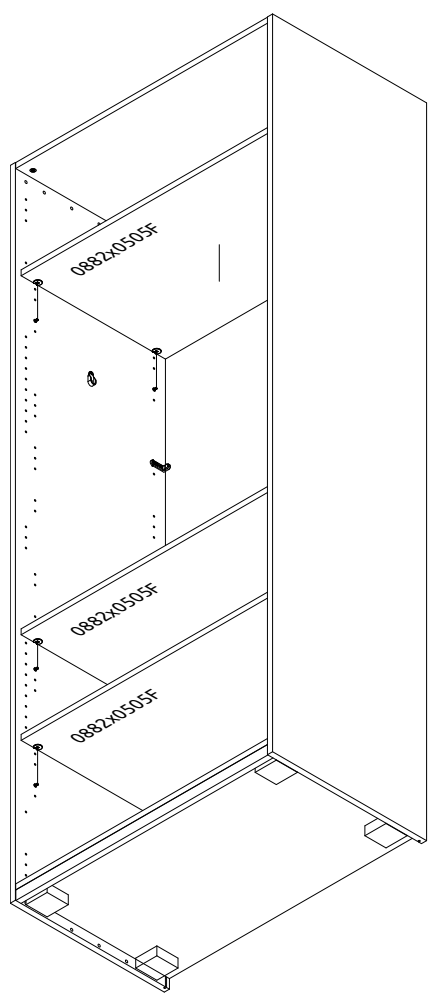

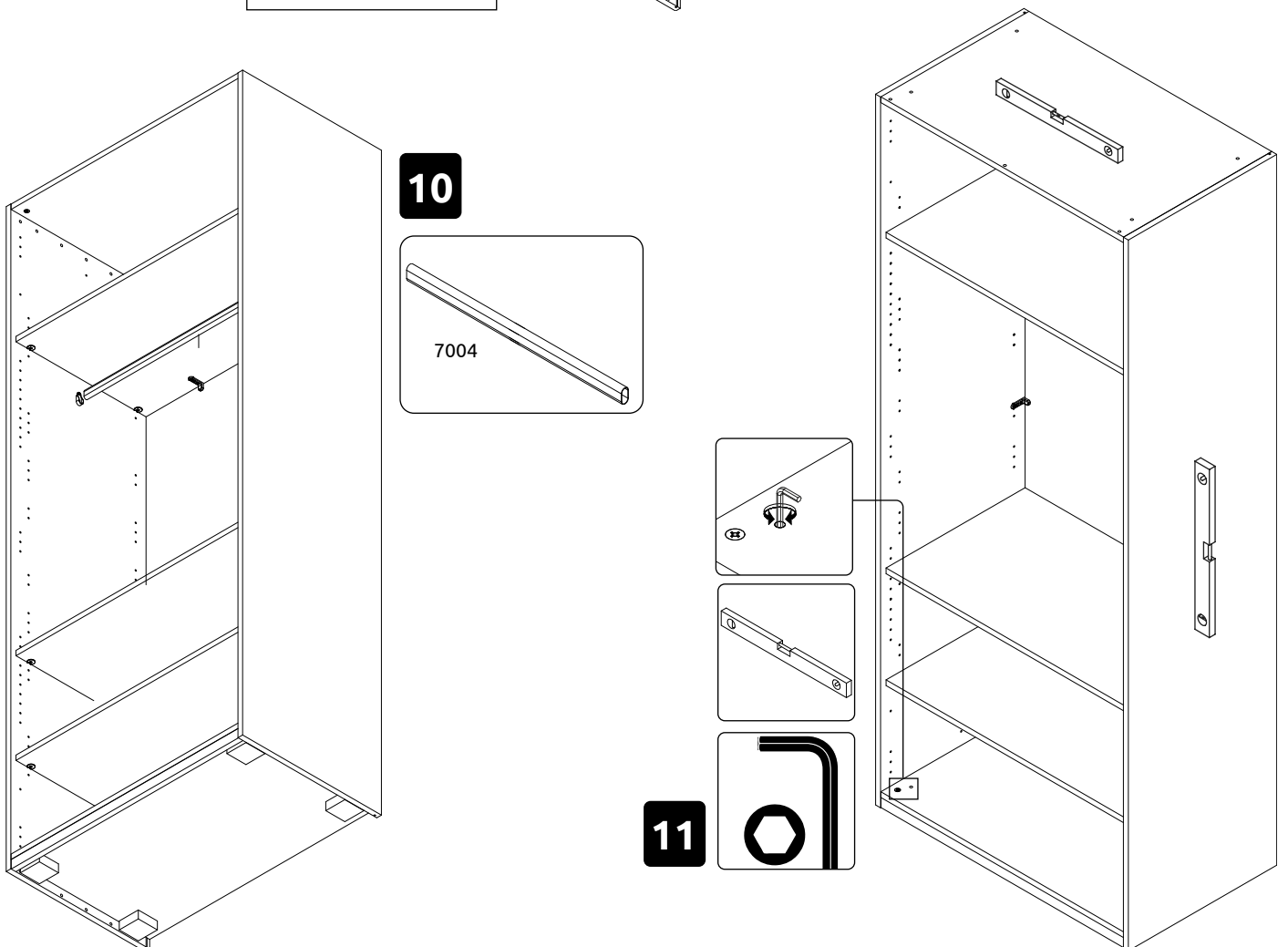
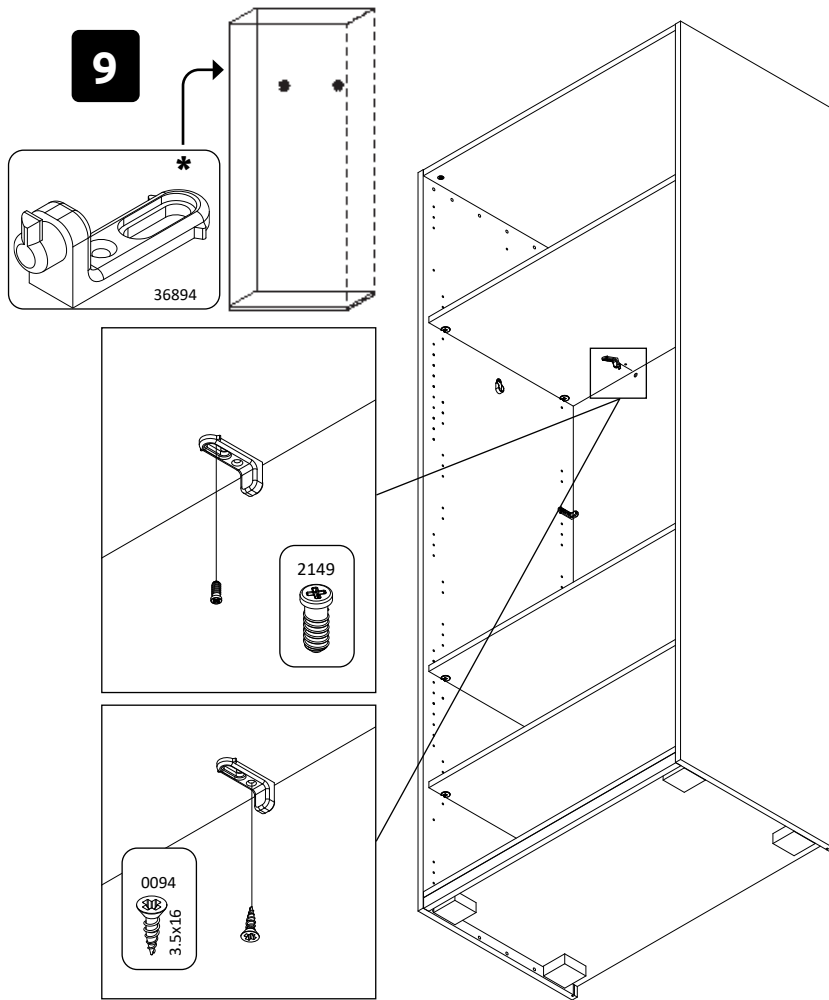

* OPT - P2 - X2
 * OPT - P2-10G - X1

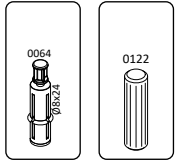

12

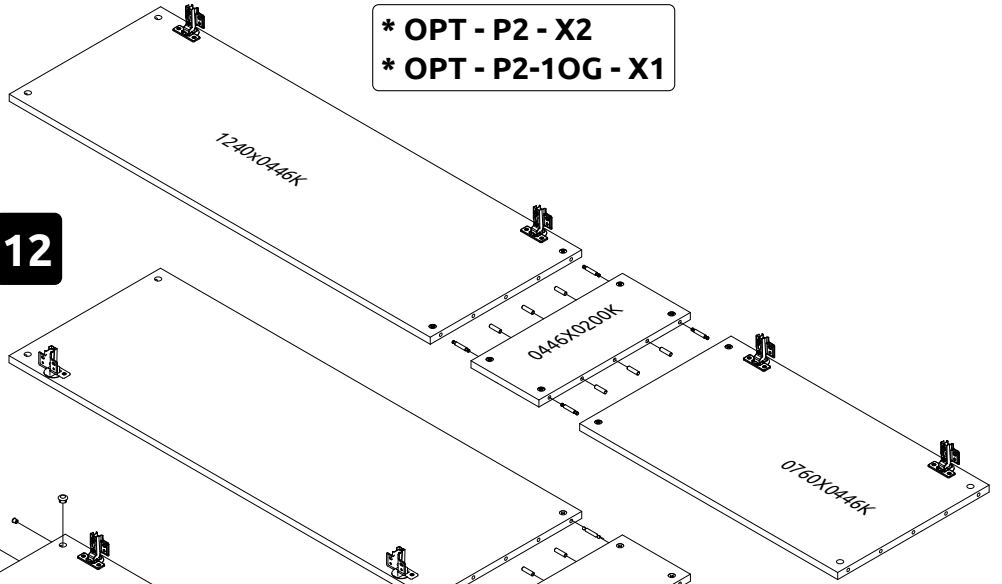

* OPT - P2 - X2
 * OPT - P2-10G - X1

13

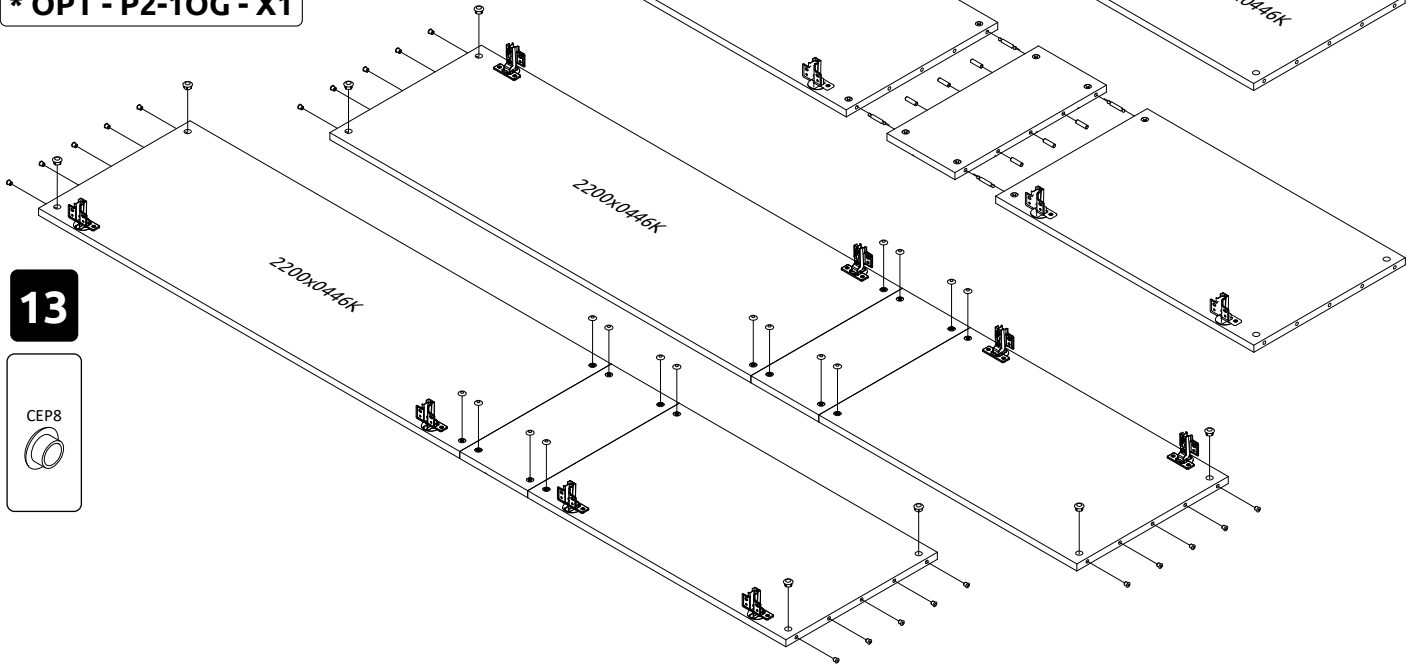

* OPT - P2

14

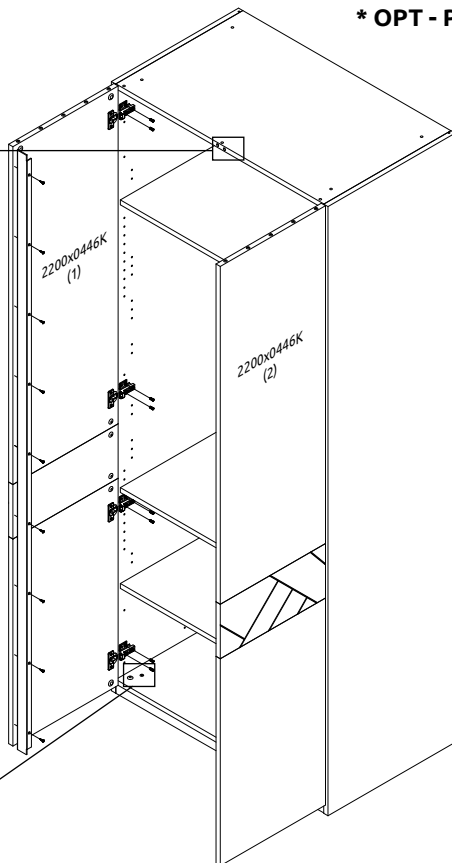
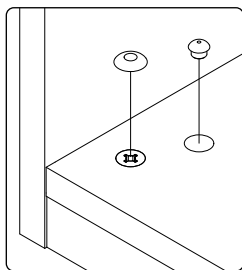
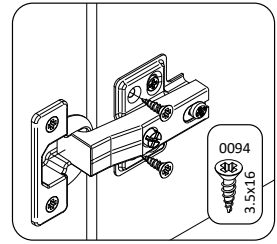
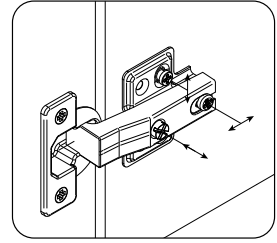
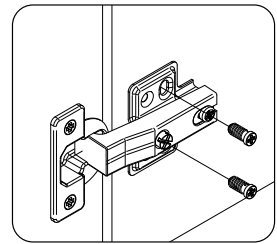
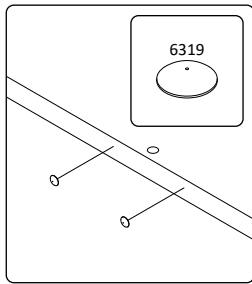

*** OPT - P2-10G**

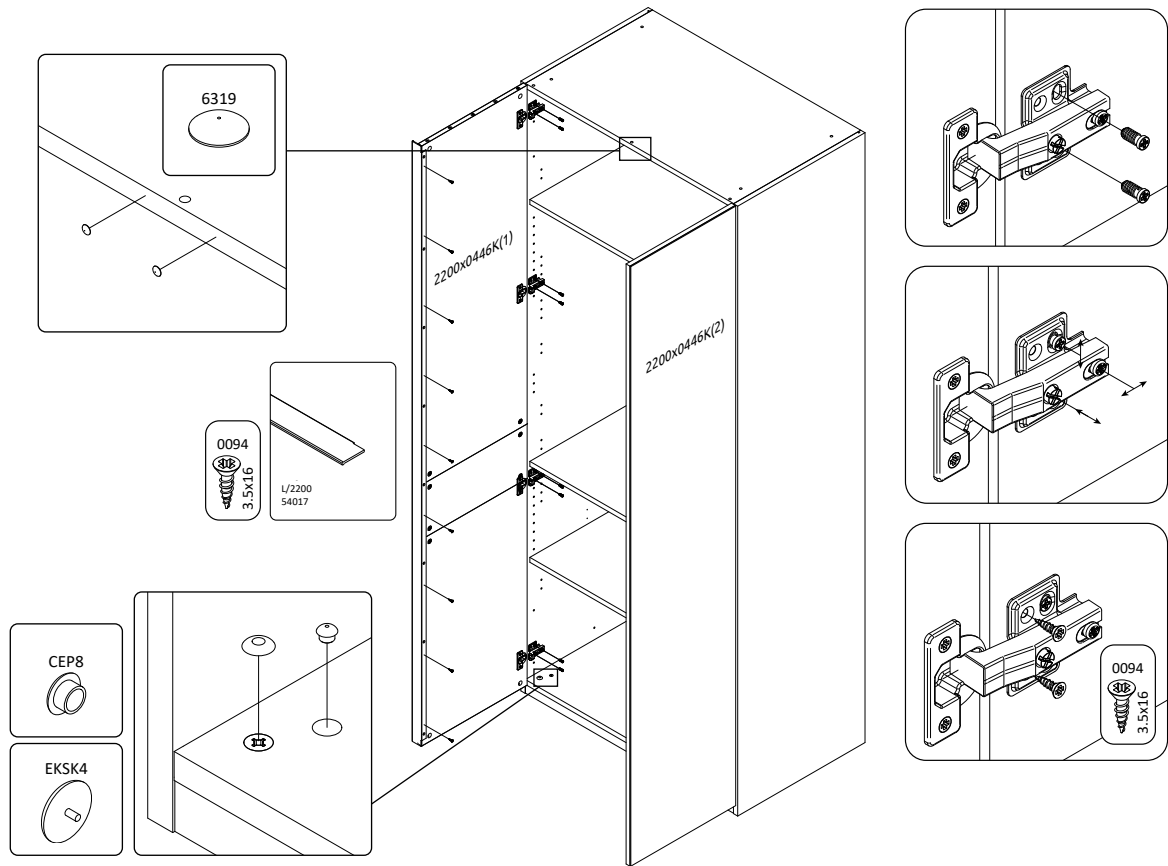

*** OPT - P2-20G**

