

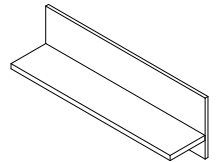

IMPORTANT - READ CAREFULLY - RETAIN FOR FUTURE REFERENCE  
WICHTIG - SORGFÄLTIG LESEN UND AUFBEWAHREN

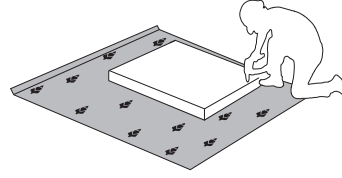

**VP90/PN**  
LWH - 897x212x297

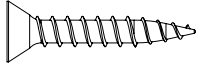
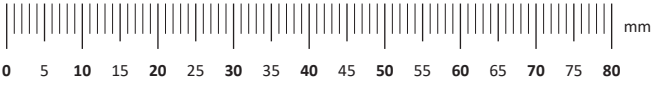
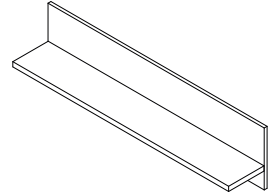

**VP120/PN**  
LWH - 1197x212x297  
41753 12.01.2019

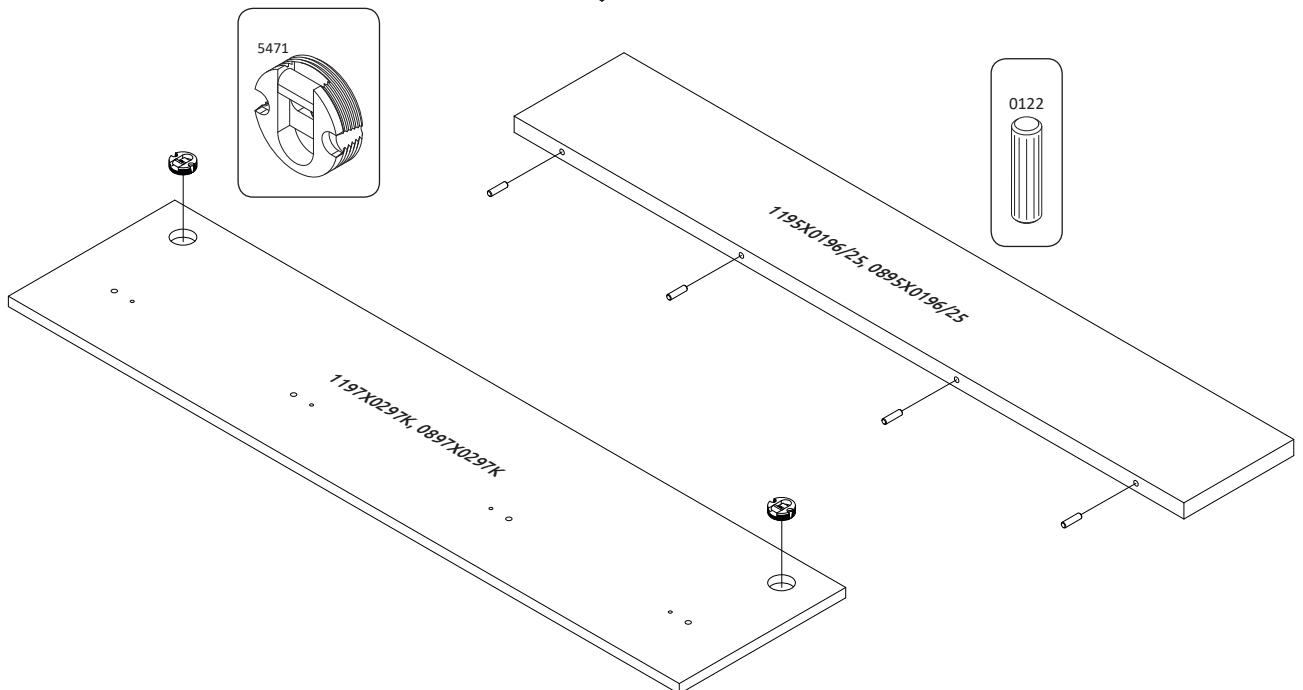
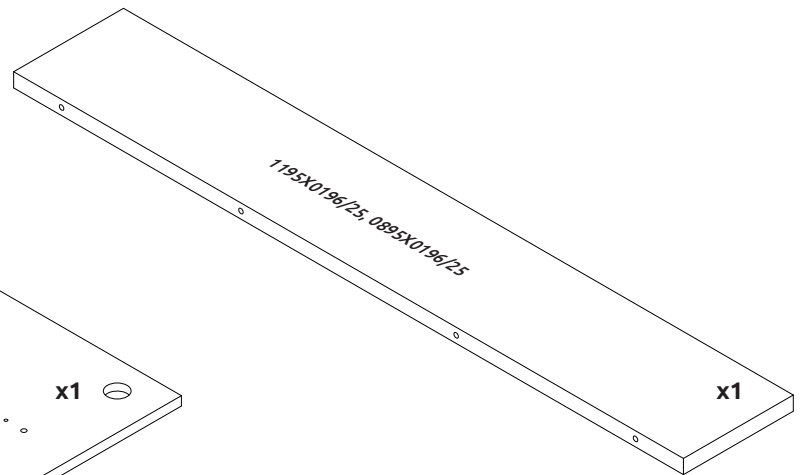
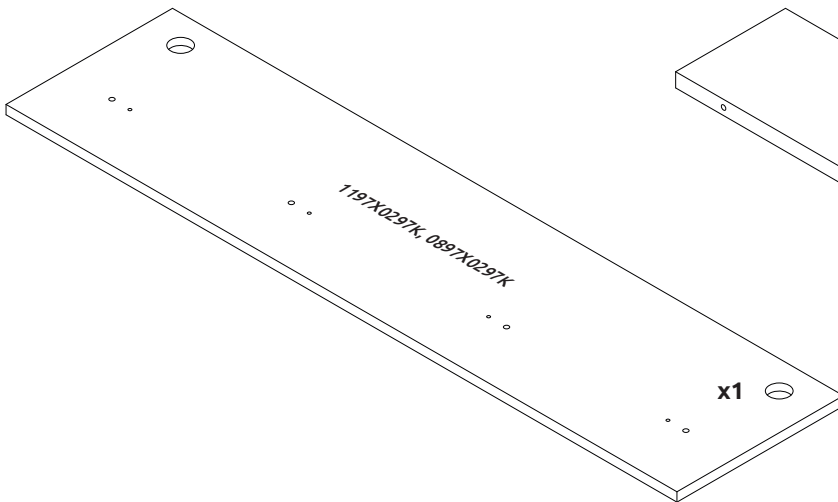
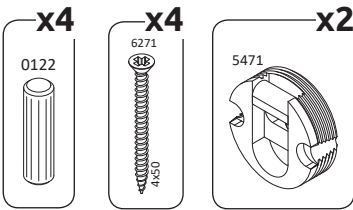

1

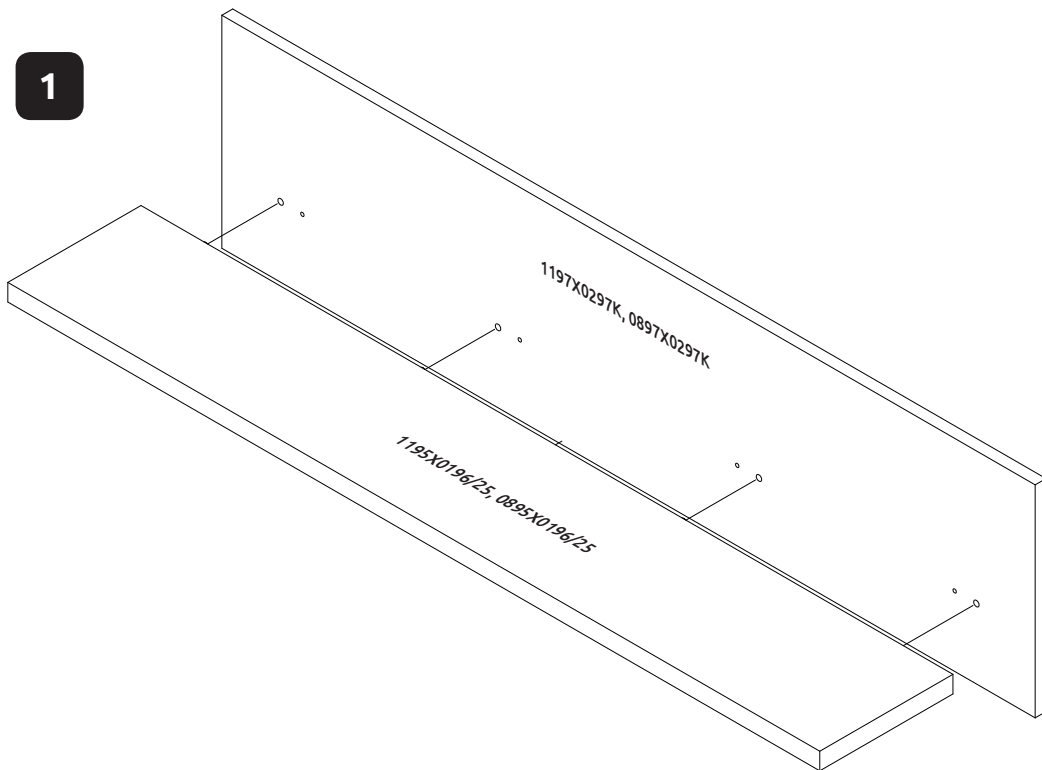

2

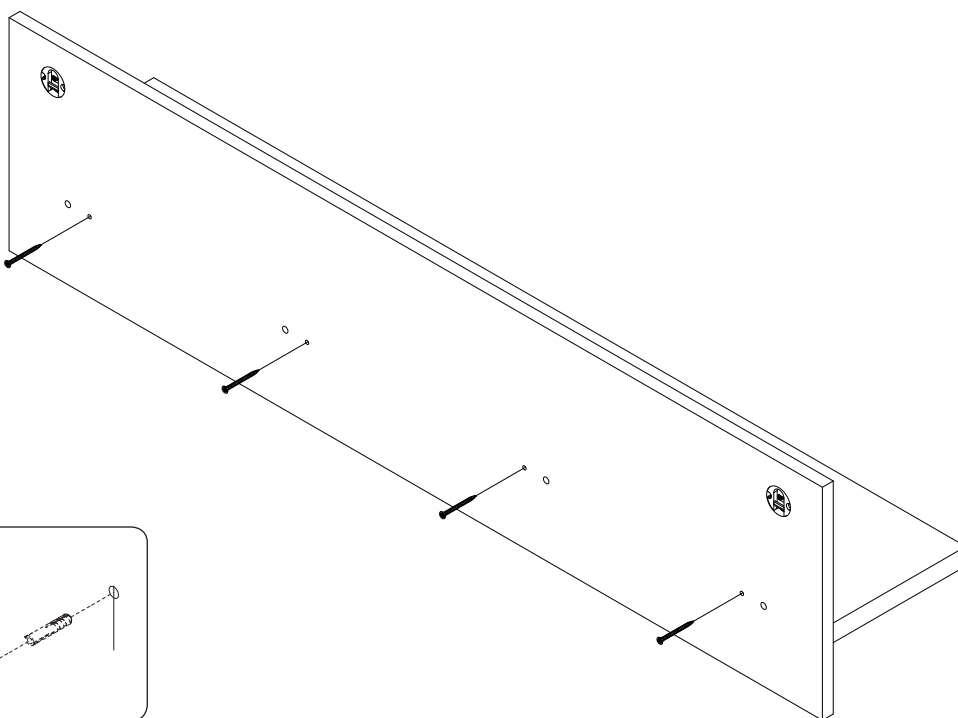
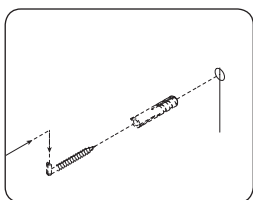
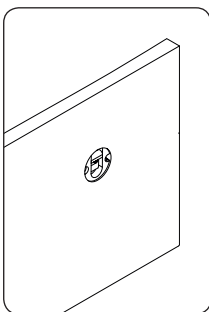
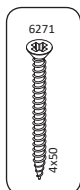
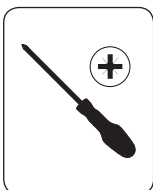

**ENGLISH**  
 Important information  
 Read carefully.  
 Keep this information for further  
 reference.

**WARNING!**  
 Fixing devices for the wall are not  
 included since different wall materials  
 require different types of fixing  
 devices. Use fixing devices suitable for  
 the walls in your home. For advice on  
 suitable fixing systems, contact your  
 local specialized dealer.

**DEUTSCH**  
 Wichtige Information Bitte sorgfältig  
 lesen und aufbewahren!

**ACHTUNG HINWEIS!**  
 Beschläge für die Wandbefestigung  
 sind nicht beige packt, da sie von  
 der jeweiligen Wandbeschaffenheit  
 abhängig sind.  
 Benutzen Sie ausschließlich  
 Befestigungsbeschläge, die für die  
 heimischen Wände geeignet sind.  
 Bei diesbezüglichen Fragen ziehen Sie  
 den örtlichen Fachhandel zu Rate.