

ACCESSORIES 1.1

rauch ORANGE +
for sliding door robes
Element width 45, 67, 90 cm



Colour	Colour code
Texline (Linen look in natural hues)	A0066



Texline



Supplier: Rauch Möbelwerke GmbH

ACCESSORIES 1.1

rauch ORANGE +

for sliding door robes
Element width 45, 67, 90 cm









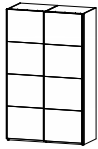
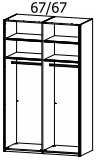
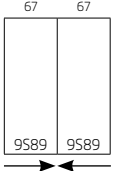
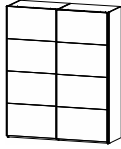
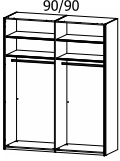
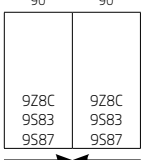
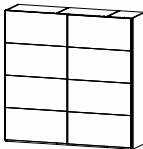
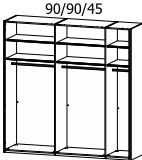
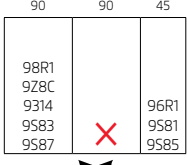
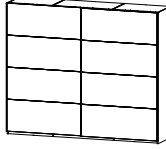
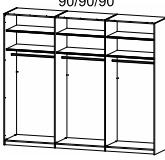
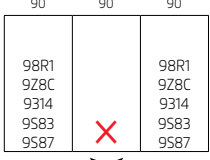
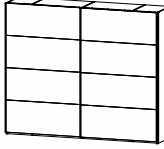
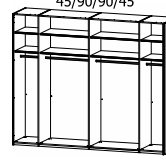
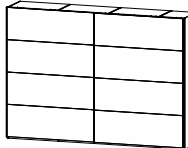
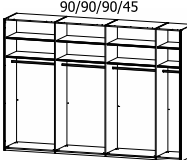
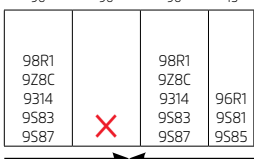



Purchase Pricelist
Prices = invoice prices in Euro

22.02.2023 SB_SIS
Valid from 01.04.2023 until revoked



These wardrobe widths are comprised of the following units:

	Sliding door wardrobes, 2-door	Options for installing drawer units, Trousers pull-outs, Clothes lifts and pull-out shelves in sliding door wardrobes	Sliding door wardrobes, 2-door	Options for installing drawer units, Trousers pull-outs, Clothes lifts and pull-out shelves in sliding door wardrobes
↔ 137 cm	 			
↔ 181 cm	 			
↔ 226 cm	 			
↔ 271 cm	 		 	Interior configuration on model: - Luisa - Tosca
↔ 316 cm	 			Interior division on model: - Nicole - X-Tend

		Colour	Colour code		
		Texline (Linen look in natural hues)	A0066		
ELEMENT WIDTH ▶		45	45	45	45
					
		Shelves for unit width 45cm ↔43 cm ↓2 cm ↗50 cm	hanging rail for unit width 45cm ↔43 cm ↓3 cm ↗2 cm	pull-out shelf for unit width 45cm ↔43 cm ↓9 cm ↗49 cm	drawer division for pull-out shelf for unit width 45cm ↔31 cm ↓5 cm ↗44 cm
	1 pieces	Price 9644	9715	96R1	96T1
	Set of 2	97F5			
Set of 3	9634				
Set of 4	99J5				
ELEMENT WIDTH ▶		45	45		
				<p>* Please note: Please be sure to observe the installation options for sliding door wardrobes.</p>	
		interior drawer with 2 drawers for unit width 45cm ↔43 cm ↓45 cm ↗50 cm	interior drawer with 3 drawers for unit width 45cm ↔43 cm ↓64 cm ↗50 cm		
	Article	Price 9S81	9S85		
	Set of 2	97F5			
ELEMENT WIDTH ▶		67	67	67	
					
		Shelves for unit width 67cm ↔66 cm ↓2 cm ↗50 cm	hanging rail for unit width 67cm ↔65 cm ↓3 cm ↗2 cm	interior drawer with 3 drawers for unit width 67cm ↔66 cm ↓64 cm ↗50 cm	
	1 pieces	Price 9425	9776	9S89	
	Set of 2	97F7			
Set of 3	9426				
Set of 4	99J7				

ACCESSORIES 1.1

rauch ORANGE +

for sliding door robes





Element width 45, 67, **90** cm



Purchase Pricelist
Prices = invoice prices in Euro

22.02.2023 SB_SIS
Valid from 01.04.2023 until revoked



* Please note: Please be sure to observe the installation options for sliding door wardrobes.



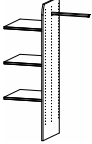
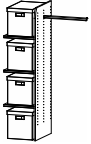
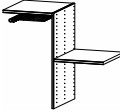
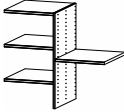

ELEMENT WIDTH ▶		90	90	90	90
					
		Shelves for unit width 90cm ↔88 cm †2 cm ↗50 cm	hanging rail for unit width 90cm ↔87 cm †3 cm ↗2 cm	pull-out shelf for unit width 90cm ↔88 cm †9 cm ↗49 cm	drawer division for pull-out shelf for unit width 90cm ↔76 cm †5 cm ↗44 cm
1 pieces	Price	9642	9719	98R1	96T3
Set of 2		97F8			
Set of 3		9632			
Set of 4		99J8			

ELEMENT WIDTH ▶		90	90		
					
		1 shelf for unit width 90cm with trouser pull-out ↔88 cm †10 cm ↗51 cm	clothes lift ↔98 cm †84 cm ↗14 cm		
Article	Price	9Z8C	9314		

ELEMENT WIDTH ▶		90	90	90	90
can be mounted on the left or right					
		wardrobe interior division with clothes rail with 3 shelves for unit width 90cm ↔88 cm †148 cm ↗51 cm	wardrobe interior division incl. 4 fabric boxes with 3 shelves for unit width 90cm ↔88 cm †148 cm ↗51 cm	wardrobe interior division with trouser holder with 2 shelves for unit width 90cm ↔88 cm †80 cm ↗51 cm	wardrobe interior division with 4 shelves for unit width 90cm ↔88 cm †80 cm ↗51 cm
Article	Price	9SJ5	9ZS9	9ZH9	9ZK9

for sliding door robes
Element width 45, 67, **90** cm

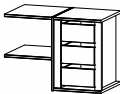
* Please note: Please be sure to observe the installation options for sliding door wardrobes.

		Colour	Colour code		
		Texline (Linen look in natural hues)	A0066		
ELEMENT WIDTH ▶		90	90	90	90
		*	*		
					
		interior drawer with 2 drawers for unit width 90cm	interior drawer with 3 drawers for unit width 90cm	interior drawer with 3 drawers with 2 shelves for unit width 90cm	interior drawer with 3 drawers with 4 shelves for unit width 90cm
		↔88 cm †45 cm ↗50 cm	↔88 cm †64 cm ↗50 cm	↔88 cm †64 cm ↗51 cm	↔88 cm †103 cm ↗51 cm
Article	Price	9S83	9S87	9SC5	9SD5
		Cupboard extras			
Article	Price				
		drawer division			
		plexiglass for drawer 80 cm			
		↔73 cm †9 cm ↗34 cm			
Article	Price	9ZP8			

ACCESSORIES 1.1

rauch ORANGE +



General



Purchase Pricelist
Prices = invoice prices in Euro

22.02.2023 SB_SIS
Valid from 01.04.2023 until revoked

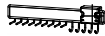

Colour	Colour code
Texline (Linen look in natural hues)	A0066

GENERAL					
					
		tie rack swivelling	tie/belt rack	tie/belt rack pull-out	extending rail holder
		↔32 cm ↓27 cm ↗6 cm	↔10 cm ↓13 cm ↗46 cm	↔9 cm ↓6 cm ↗45 cm	↔4 cm ↓6 cm ↗31 cm
Article	Price	9768	990K	9GK1	9760

GENERAL					
					
		hooks	trouser holder	coat hanger rail	
		↔35 cm ↓5 cm ↗5 cm	↔25 cm ↓7 cm ↗46 cm	↔7 cm ↓52 cm ↗28 cm	
Article	Price	9HL1	990H	9767	

		Colour	Colour code
		Texline (Linen look in natural hues)	A0066
GENERAL			
		interior mirror for hinged doors	interior mirror, for sliding doors
		↔29 cm ↓130 cm ↗0 cm	↔46 cm ↓115 cm ↗4 cm
Article	Price	98S8	9408

		Door dampers rauch EASY SLIDE		
		Installation not possible on wardrobes with front lighting.	Installation not possible on wardrobes with front lighting.	
		set of 2 dampers for sliding wardrobes EASY SLIDE of 2-4 door sliding door wardrobes	damper for middle door EASY SLIDE of 3 door Sliding door wardrobes	Collision dampers EASY SLIDE of 2 door Sliding door wardrobes
		↔61 cm ↓2 cm ↗5 cm	↔28 cm ↓2 cm ↗4 cm	↔14 cm ↓9 cm ↗2 cm
Article	Price	9DM1	9DM4	9DM6

		LIGHTING		
		interior lights with motion sensor LED light	lighting control with handheld transmitter	
		↔23 cm ↓2 cm ↗11 cm		
Article	Price	9T1B	99FB	

ACCESSORIES 1.1

rauch ORANGE +

General

Purchase Pricelist
Prices = invoice prices in Euro

22.02.2023 SB_SIS
Valid from 01.04.2023 until revoked



Colour	Colour code
Texline (Linen look in natural hues)	A0066

LIGHTING		BALENO
		<p>LED bar lamp</p> <p>↔90 cm ↕6 cm ↗19 cm</p>
Article	Price	9W1L
<p>This product contains a light source of the energy efficiency class E.</p> <p>EPREL 768436</p>		

LIGHTING		LUCIDO	NEELA	LUNA	LOFT
		set of 2 LED lights	set of 2 LED lights	set of 2 LED lights	set of 2 LED lights
		↔27 cm ↕7 cm ↗14 cm	↔89 cm ↕6 cm ↗18 cm	↔21 cm ↕9 cm ↗33 cm	↔33 cm ↕5 cm ↗18 cm
Article	Price	9L42	9L62	94L2	9C74
Article	Price	9L43		94L3	9C76

LIGHTING		LUCIDO	NEELA	LUNA	LOFT
		This product contains a light source of the energy efficiency class F.	This product contains a light source of the energy efficiency class E.	This product contains a light source of the energy efficiency class E.	This product contains a light source of the energy efficiency class G.
		EPREL 936418	EPREL 766774	EPREL 766798	EPREL 766530