

20.21.1301.00

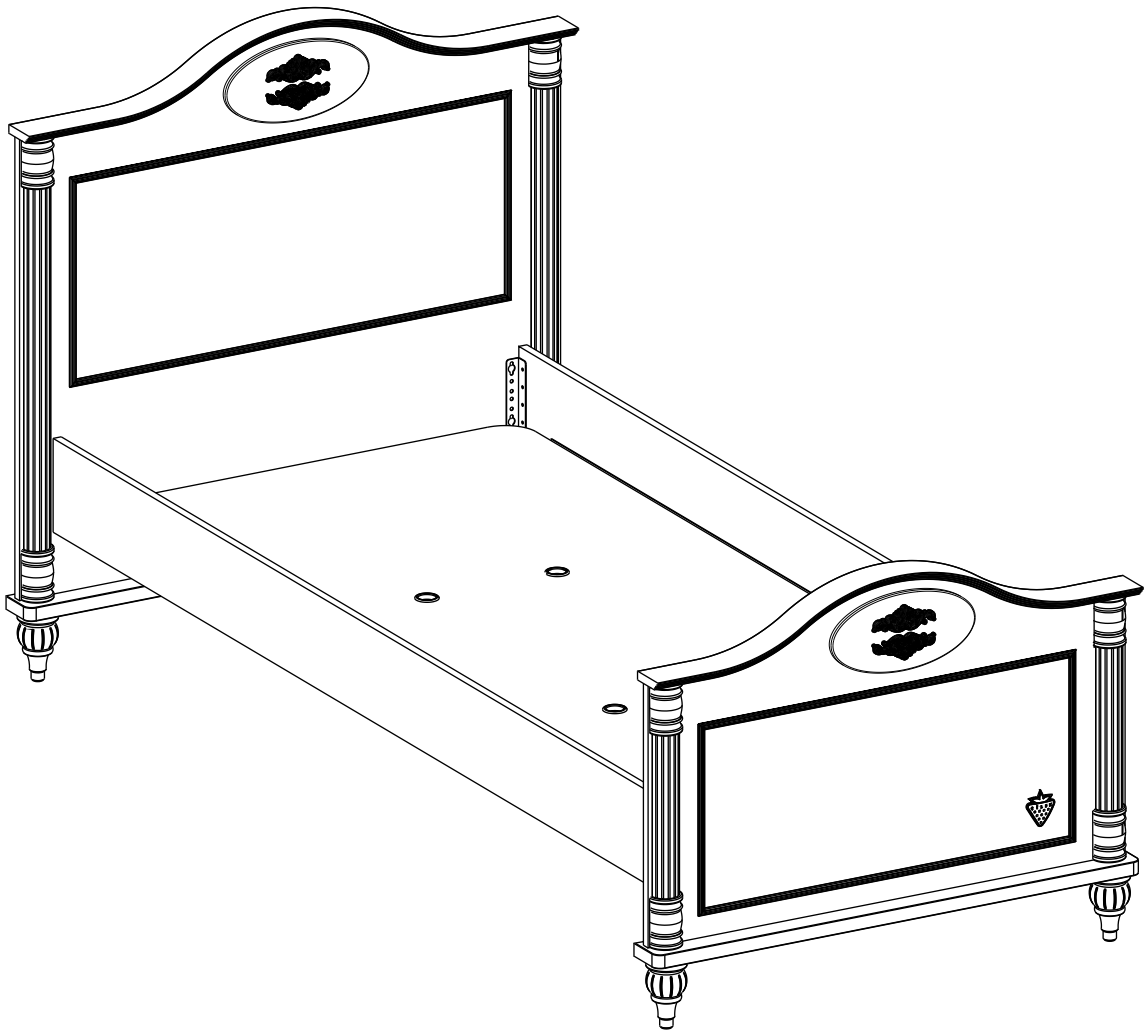

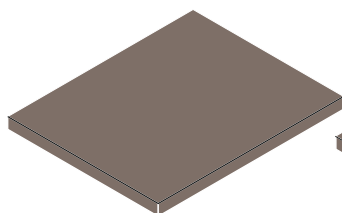

4/1

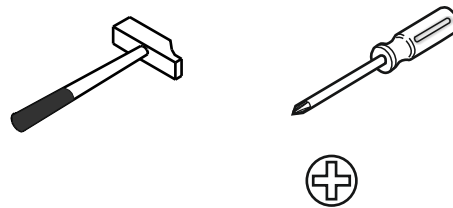
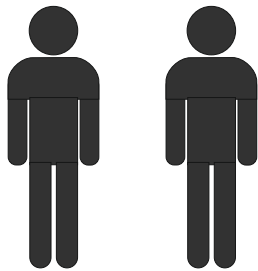
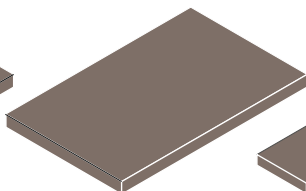

4/2

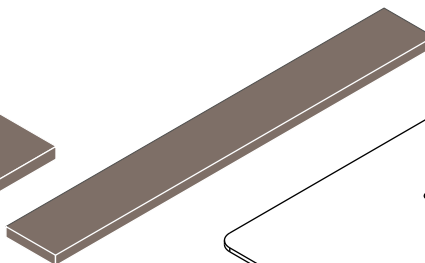

4/3

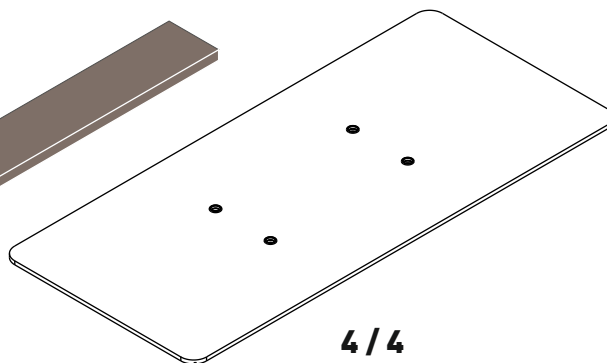

4/4

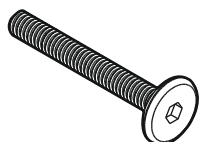

13.03.01.039 x 10

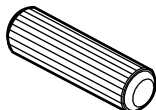

13.01.01.111 x 10



13.02.01.017 x 30

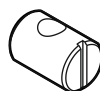

13.07.01.287 x 10



13.02.01.015 x 16

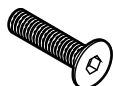

13.03.01.034 x 4



13.03.01.021 x 16

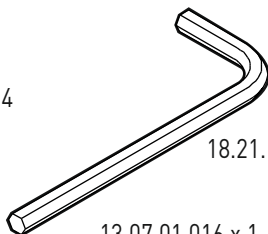

18.21.1301.202 x 2

13.07.01.016 x 1

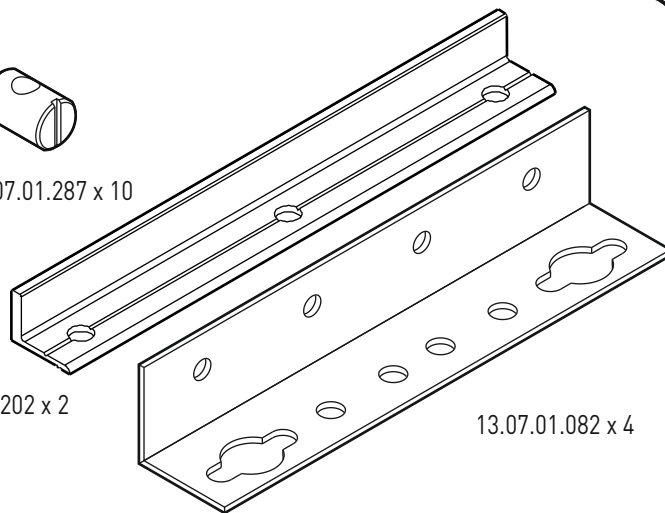

13.07.01.082 x 4

4/1

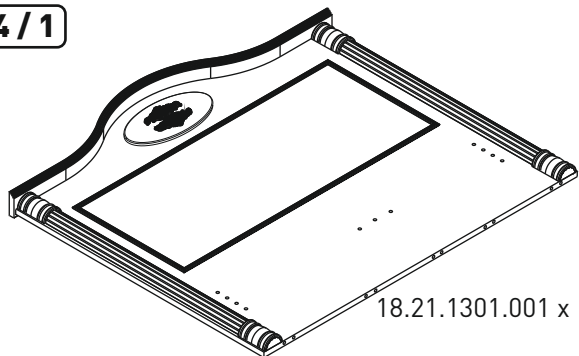

18.21.1301.001 x 1

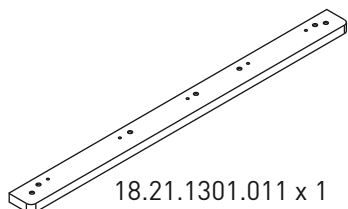

18.21.1301.011 x 1

4/2

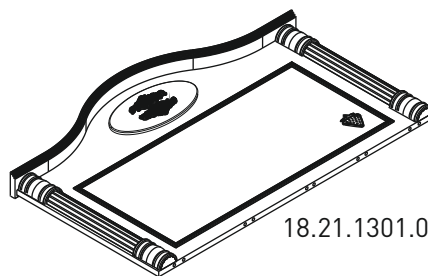

18.21.1301.006 x 1

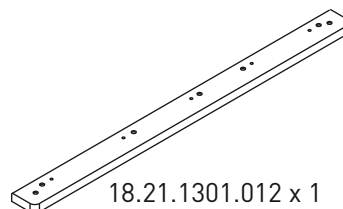

18.21.1301.012 x 1



13.01.01.293 x 4

4/3

18.21.1301.005 x 2

18.21.1301.201 x 2

4/4

18.21.1301.010 x 1

1

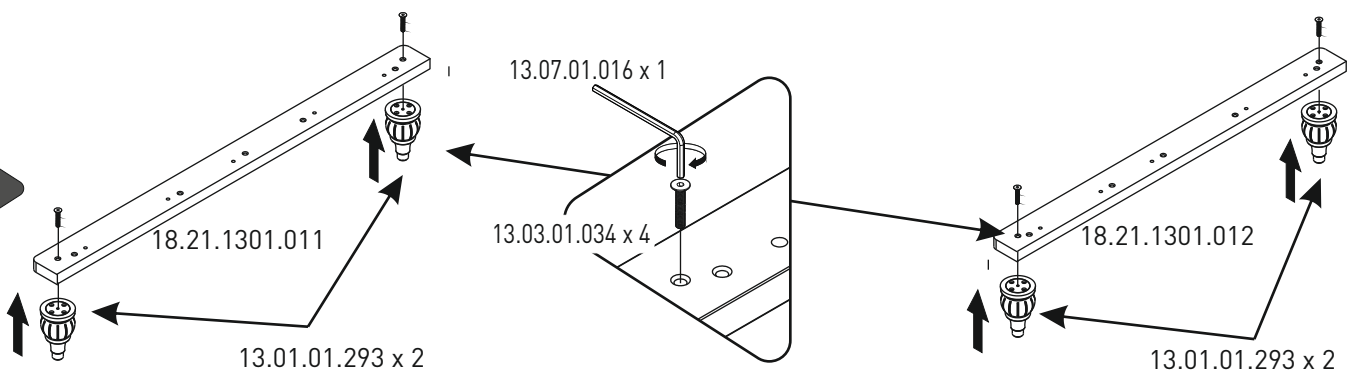

2

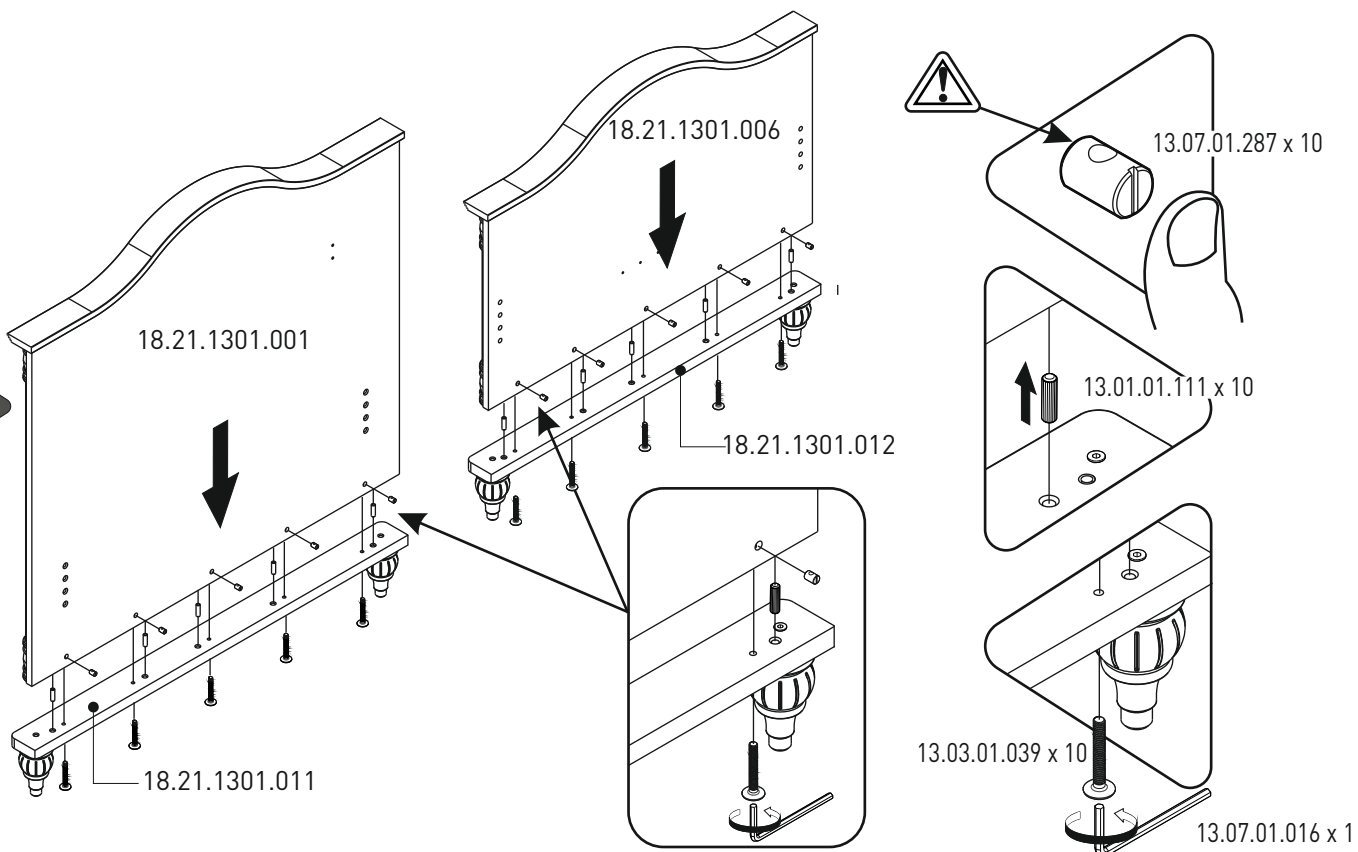

3

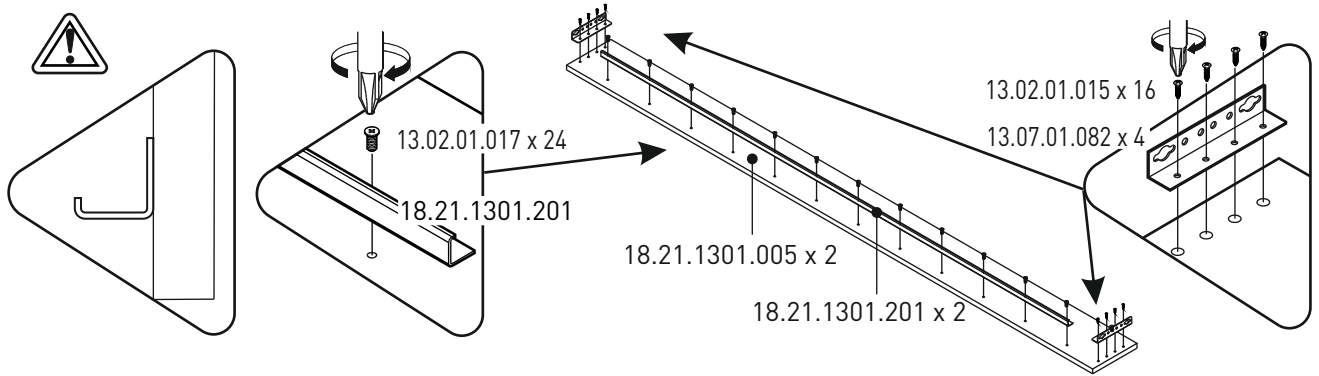

4

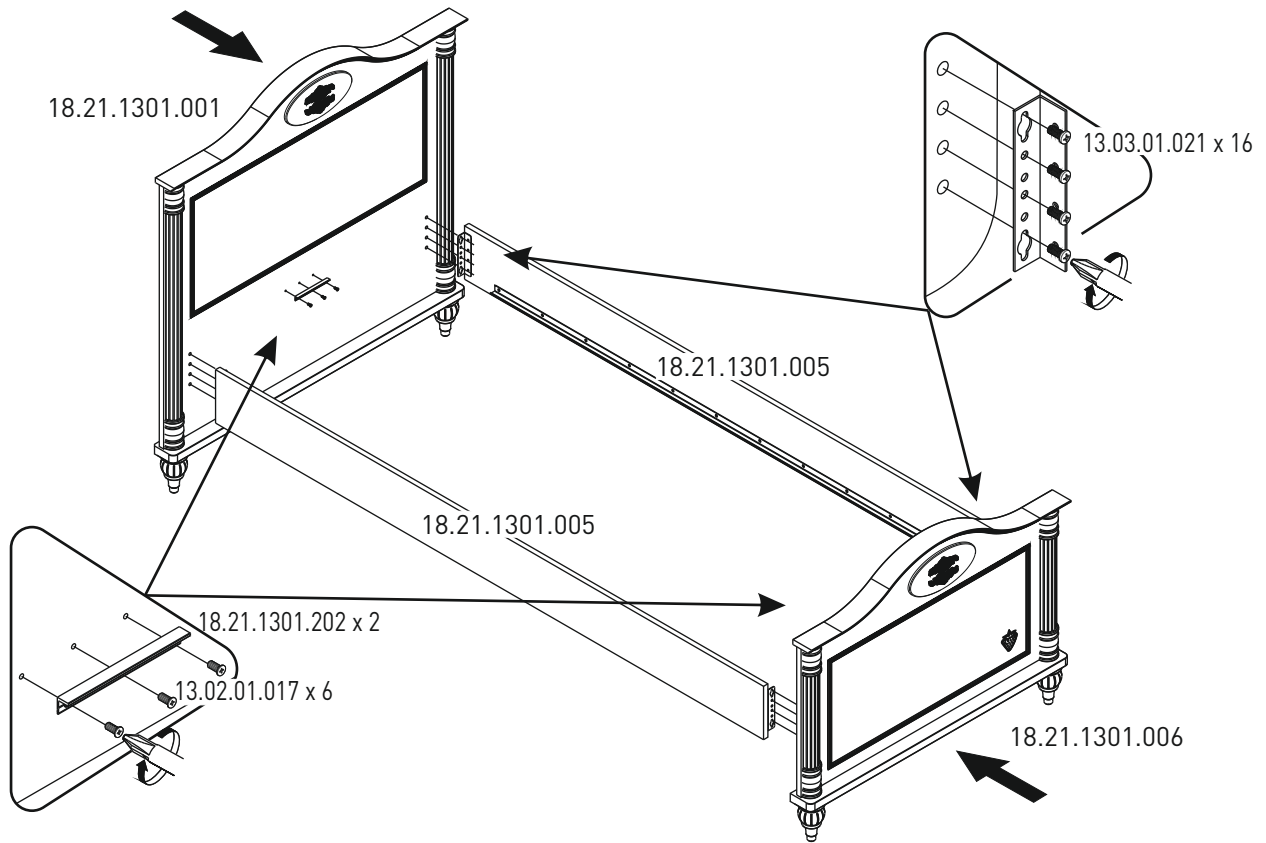

5

