

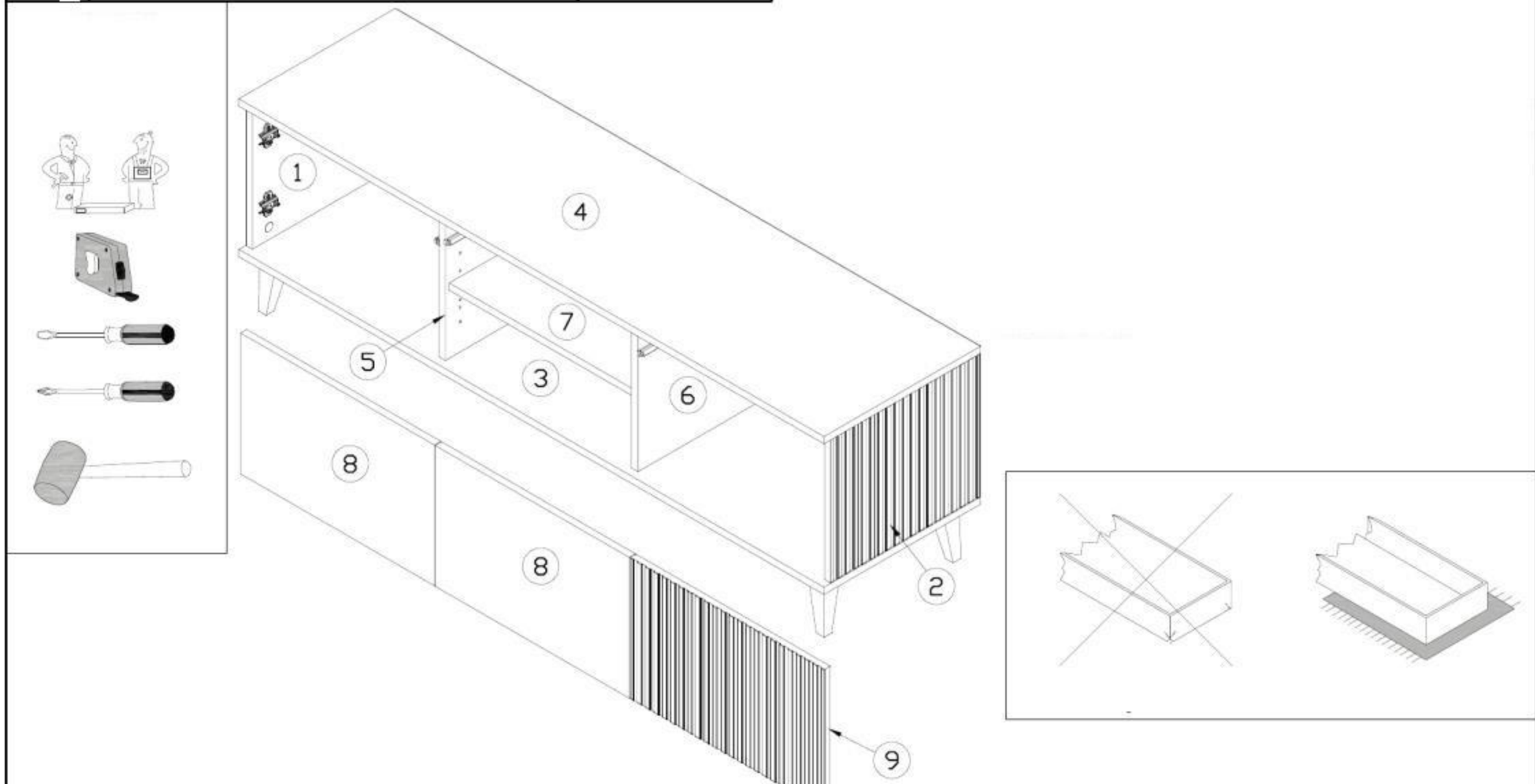









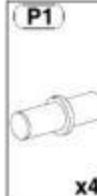

Model: **RANDOM TV 150** **1/11**





BAG 1

-  **G1**
x40
-  **K32**
x16
-  **L1**
x1
-  **P1**
x4
-  **R1**
x12
-  **R28**
x12
-  **W1**
x4
-  **X30**
x3
-  **Z1**
x12



BAG 2

-  **Z22**
x4
-  **Z23**
x4
-  **W48**
x8

BAG 3

-  **Z128**
x2
-  **Z127**
x2
-  **W48**
x4

BAG 4

-  **W47**
Ø3,5x16
x20
-  **N1**
x5

BAG 5

-  **B40**
x1

Model:

RANDOM TV 180

2/11

1

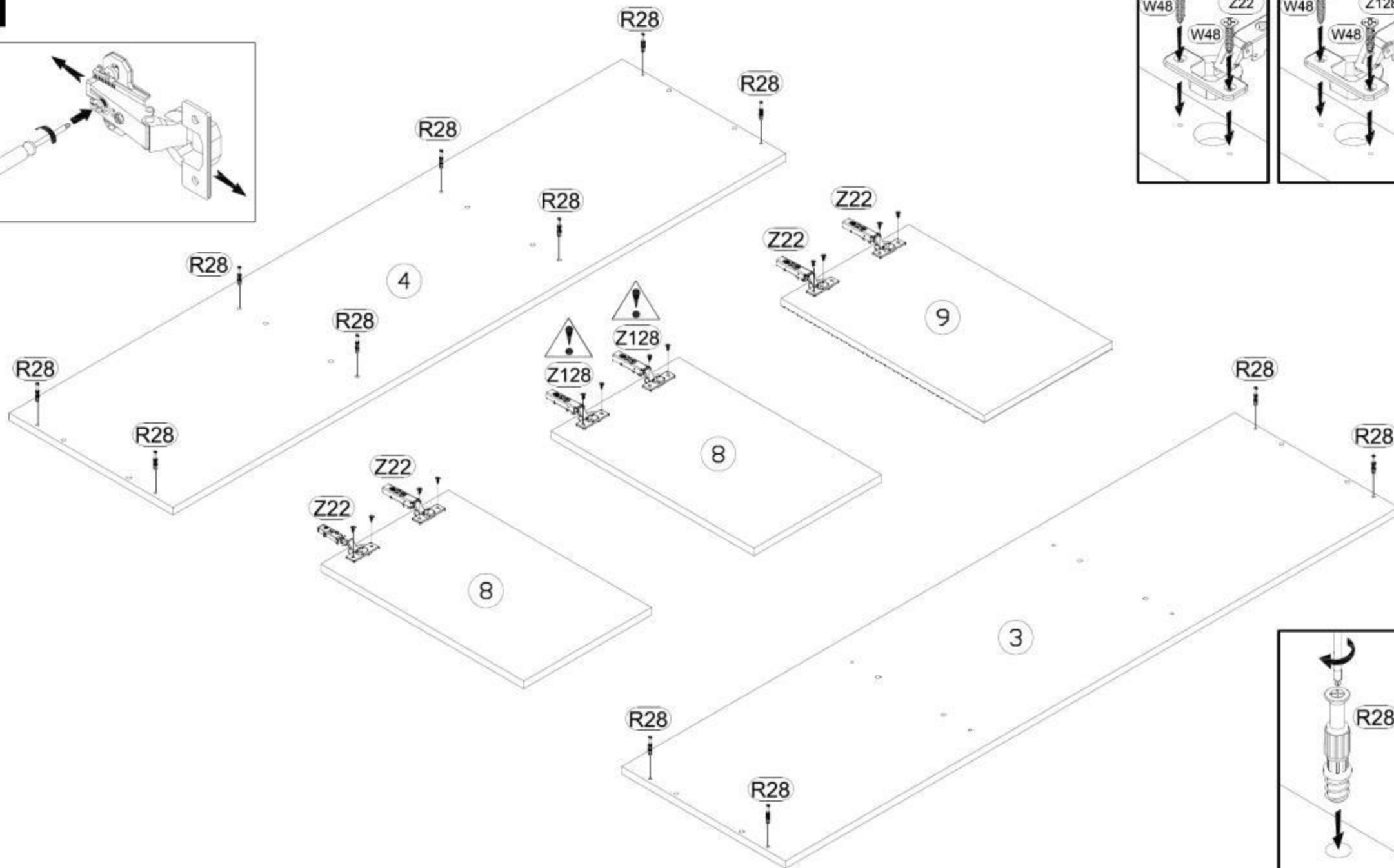
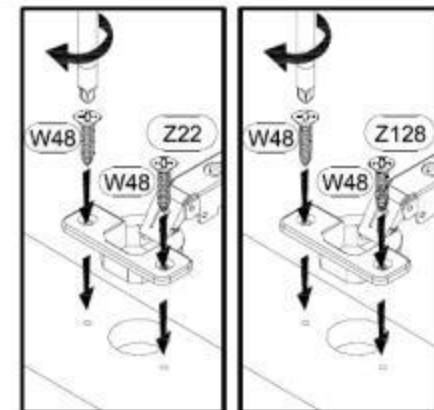
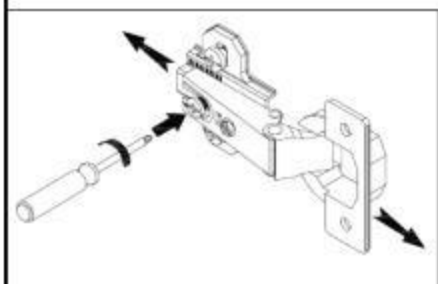

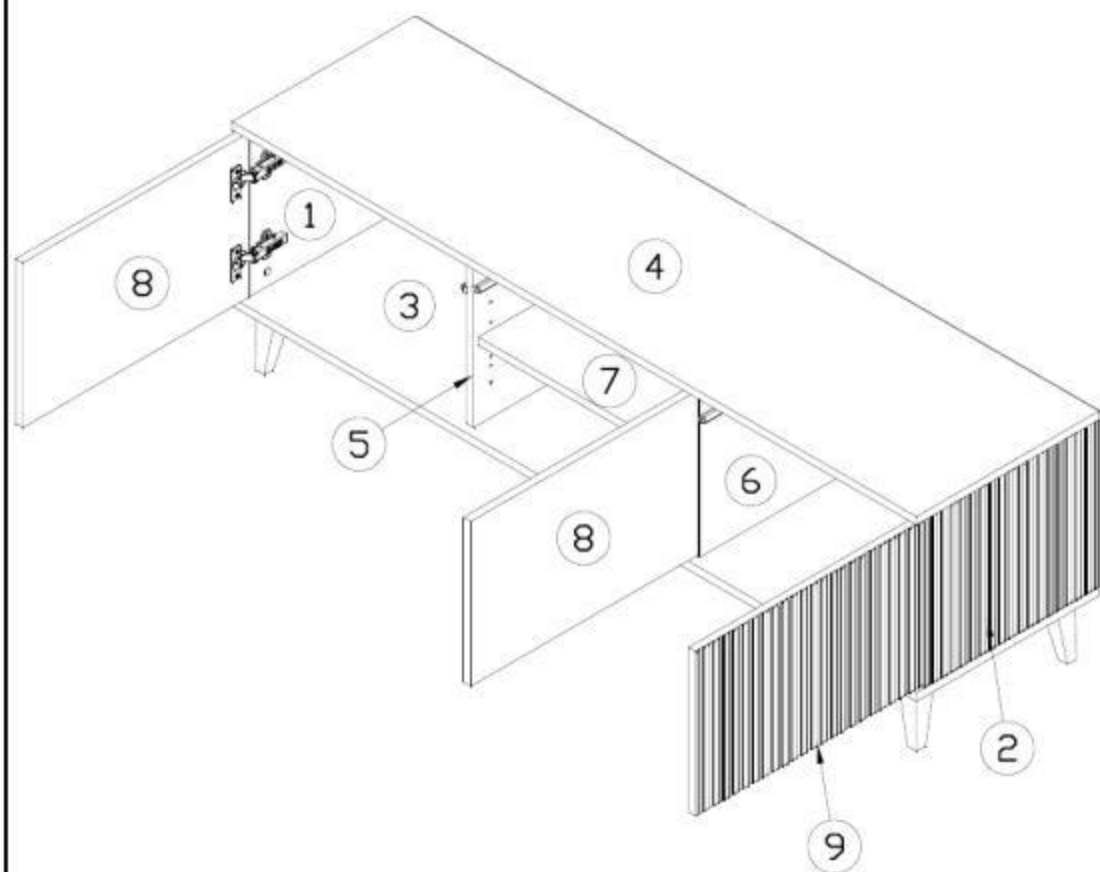

"RIGHT" 2-5

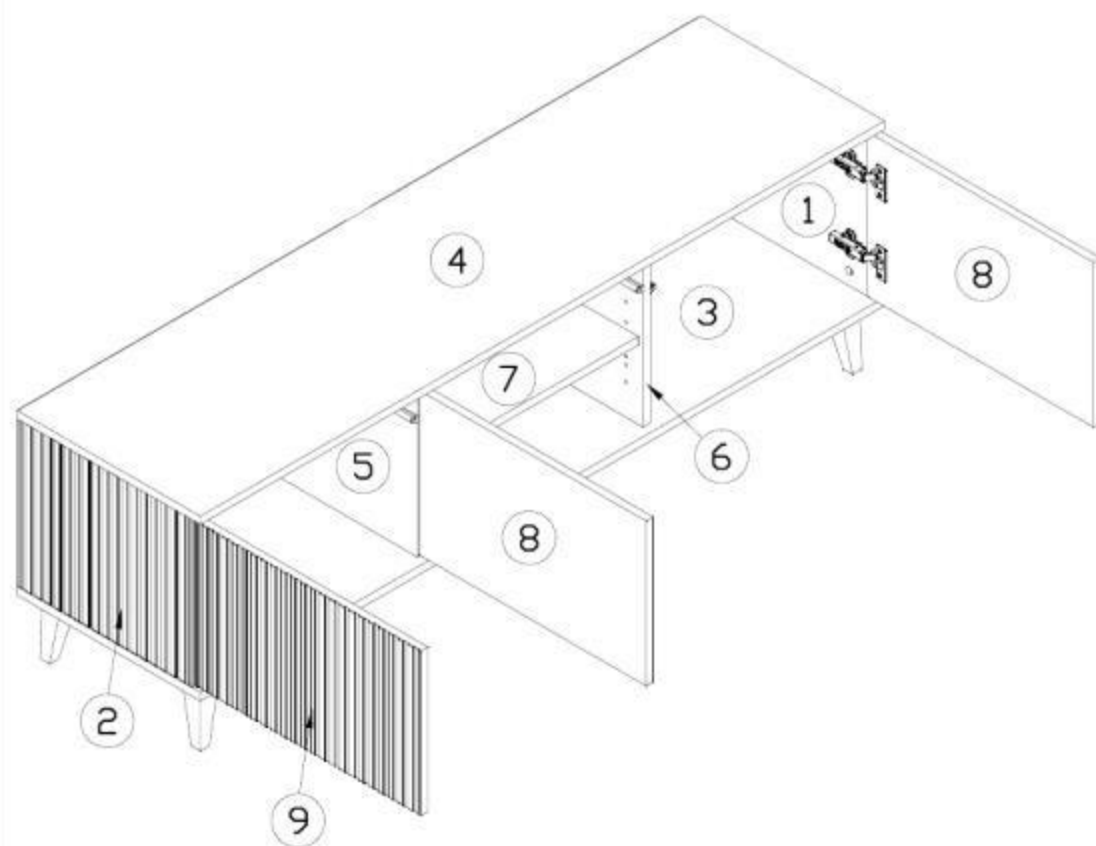

"LEFT" 6-9

2

R

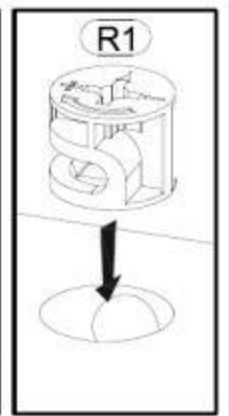
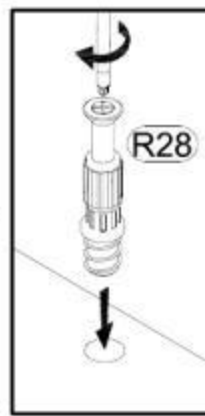
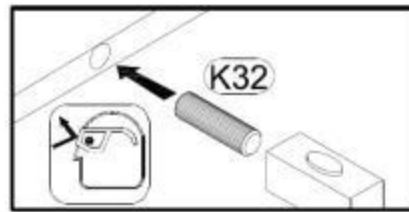
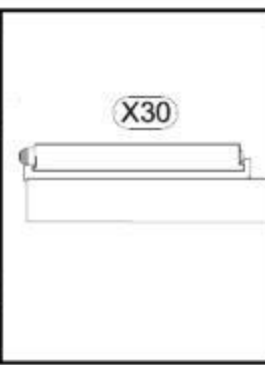
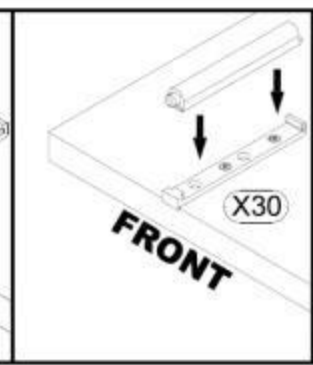
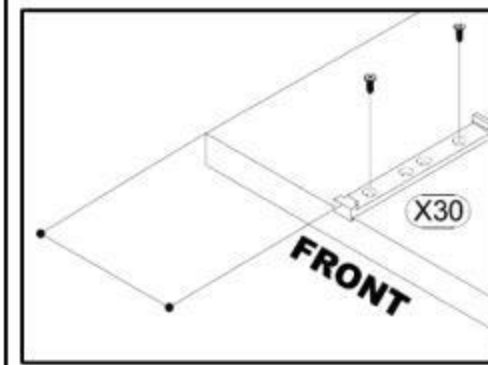
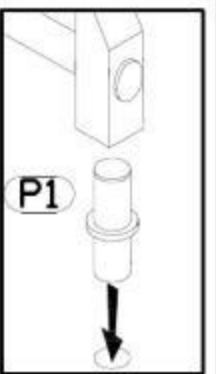
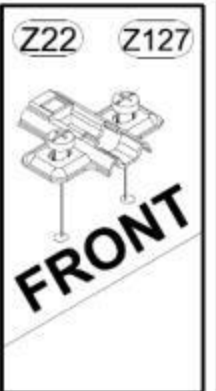
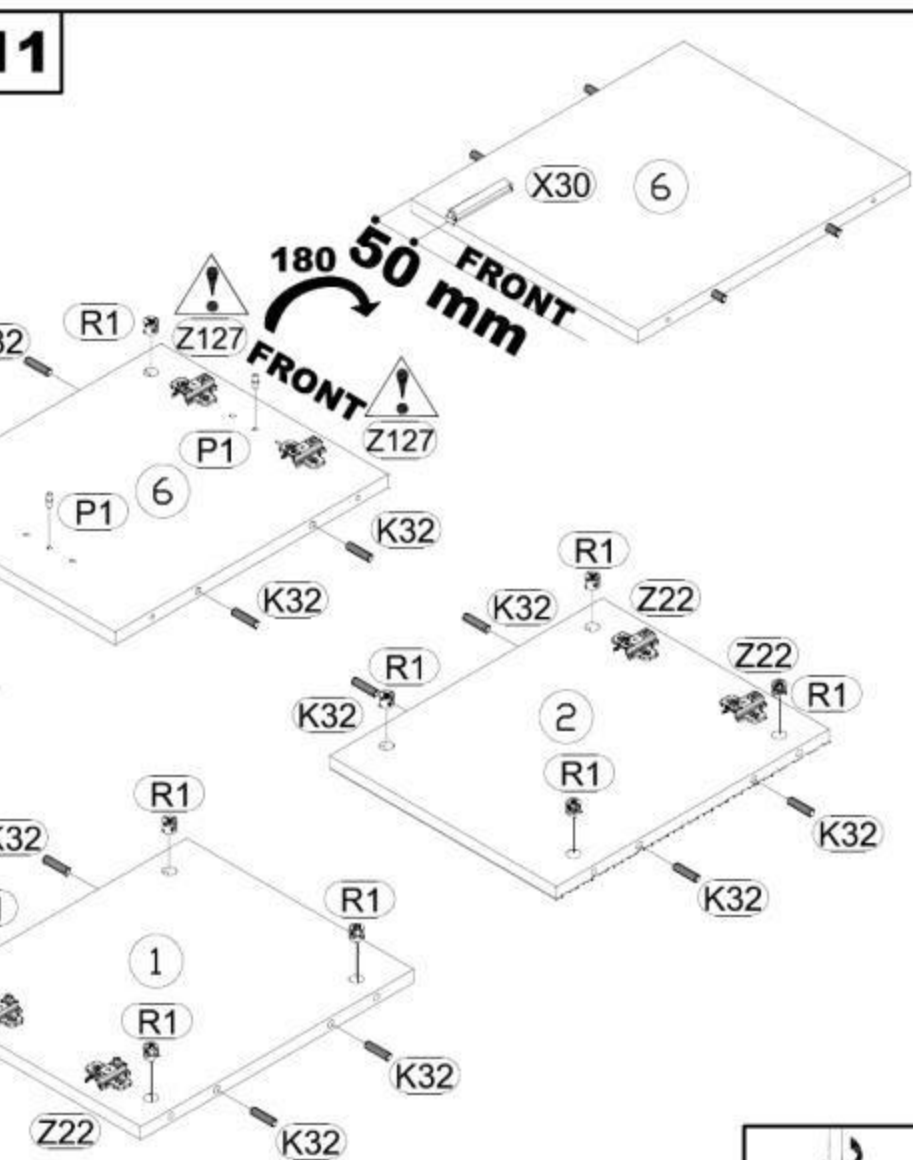
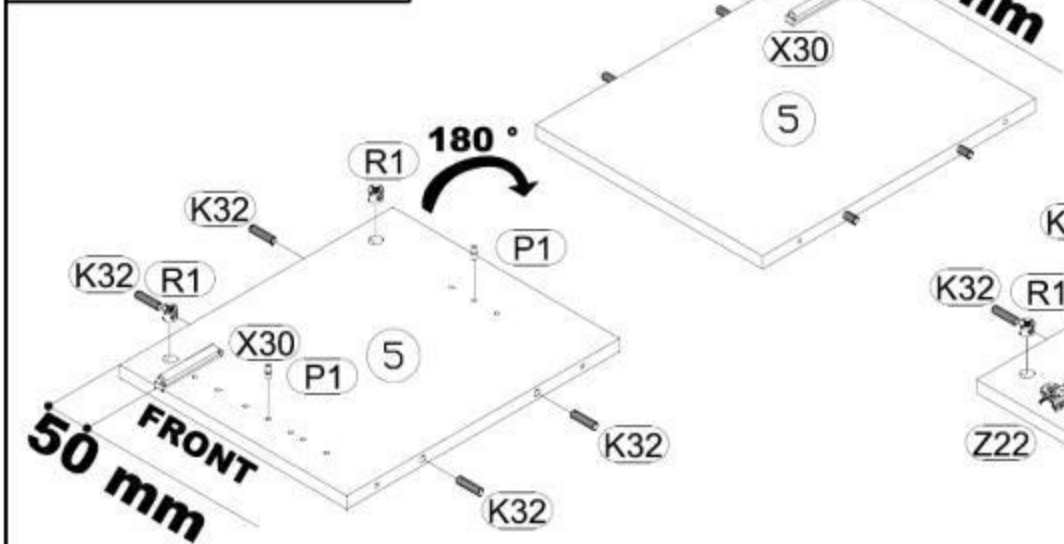
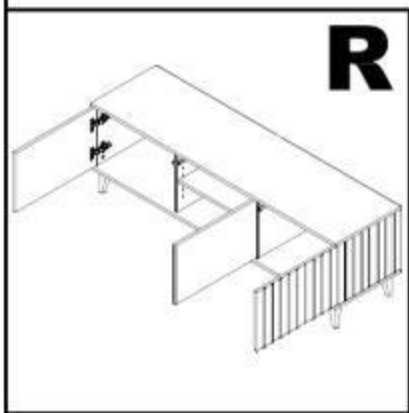

Model:

RANDOM TV 150

5/11

3

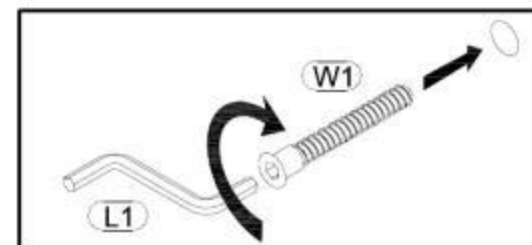
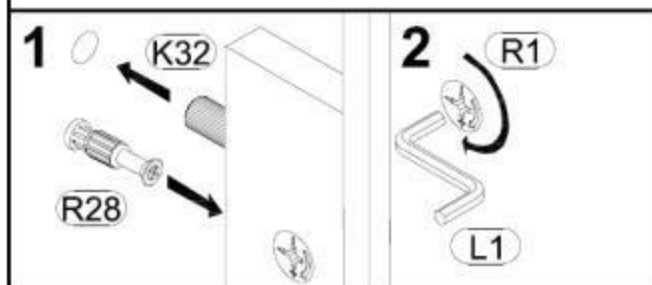
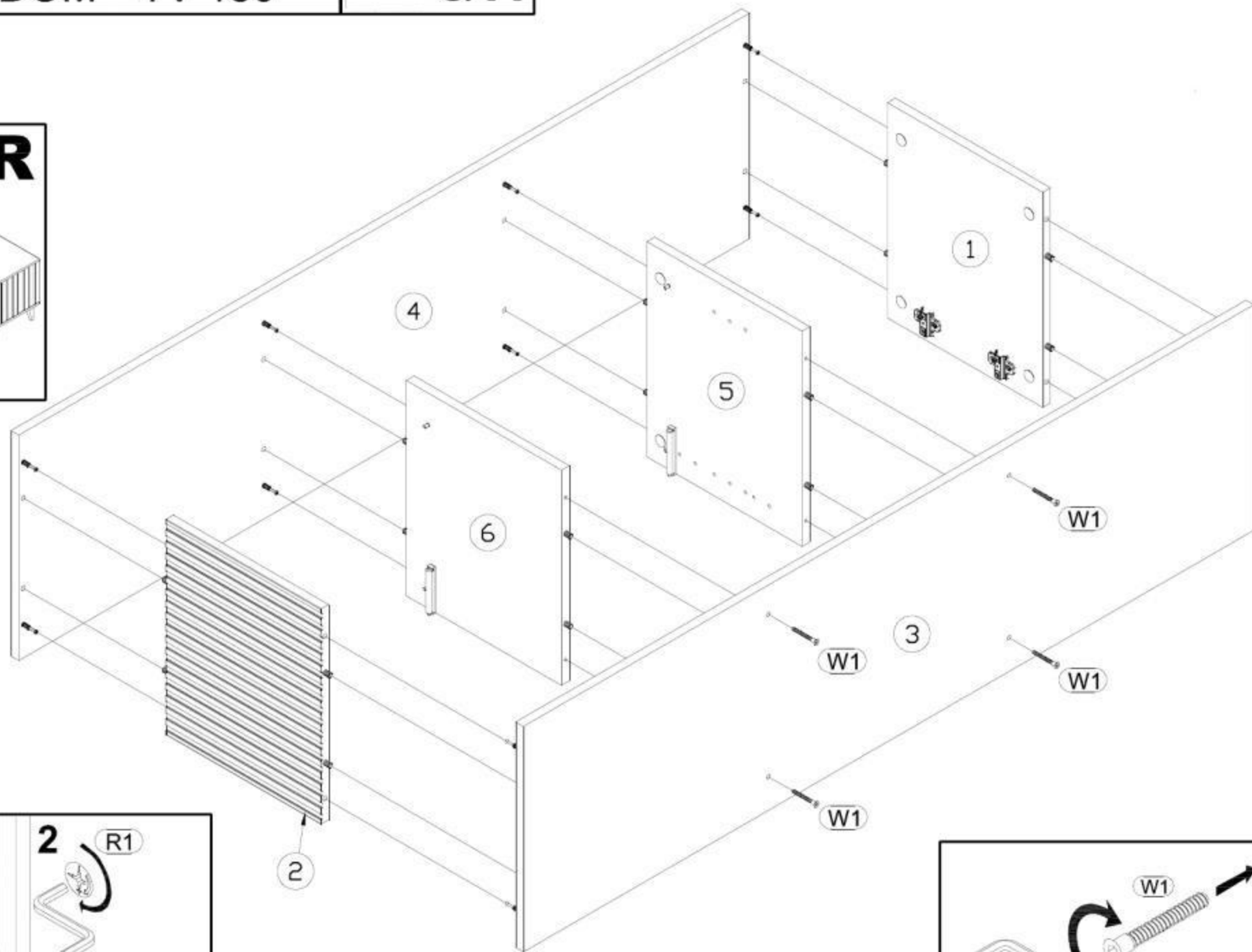
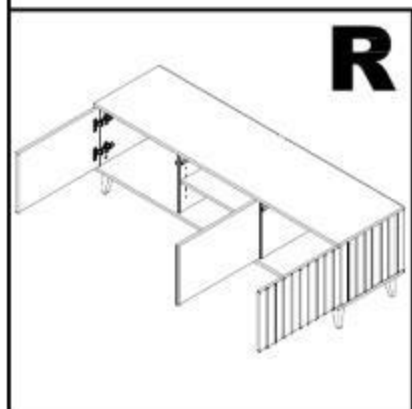

Model:

RANDOM TV 150

6/11

4

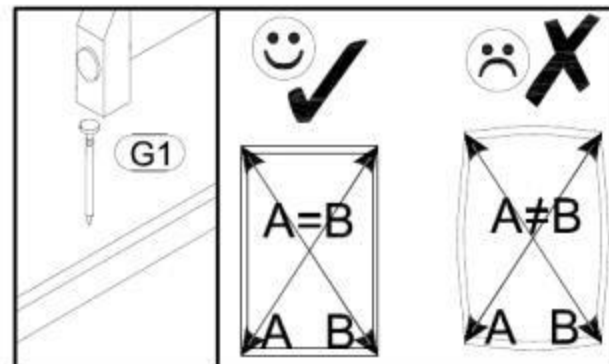
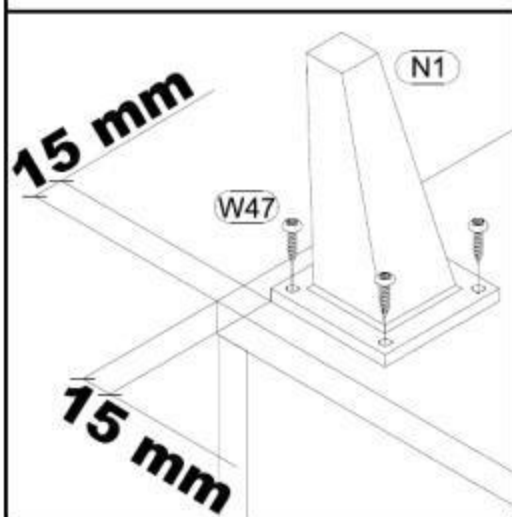
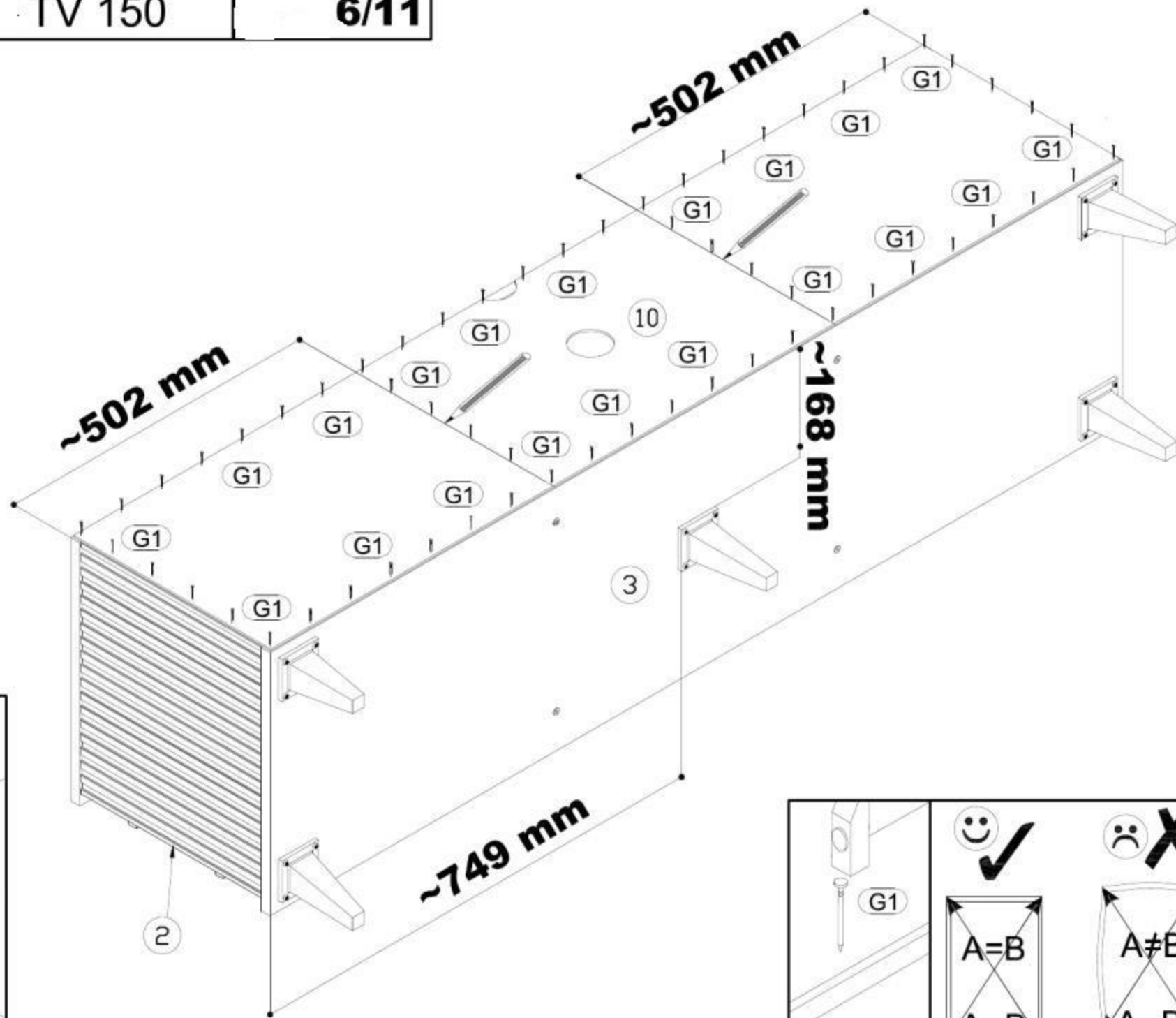
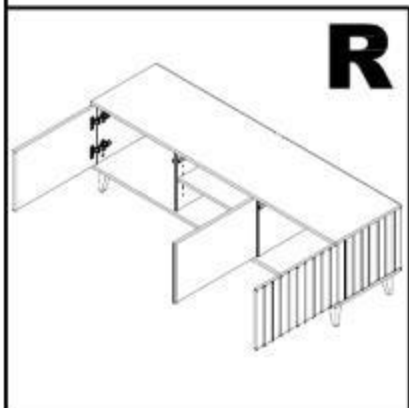

Model:

RANDOM TV 150

7/11

5

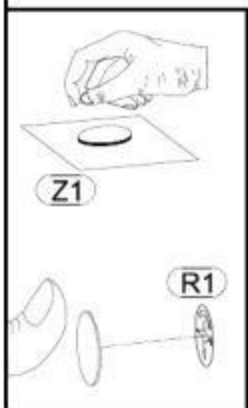
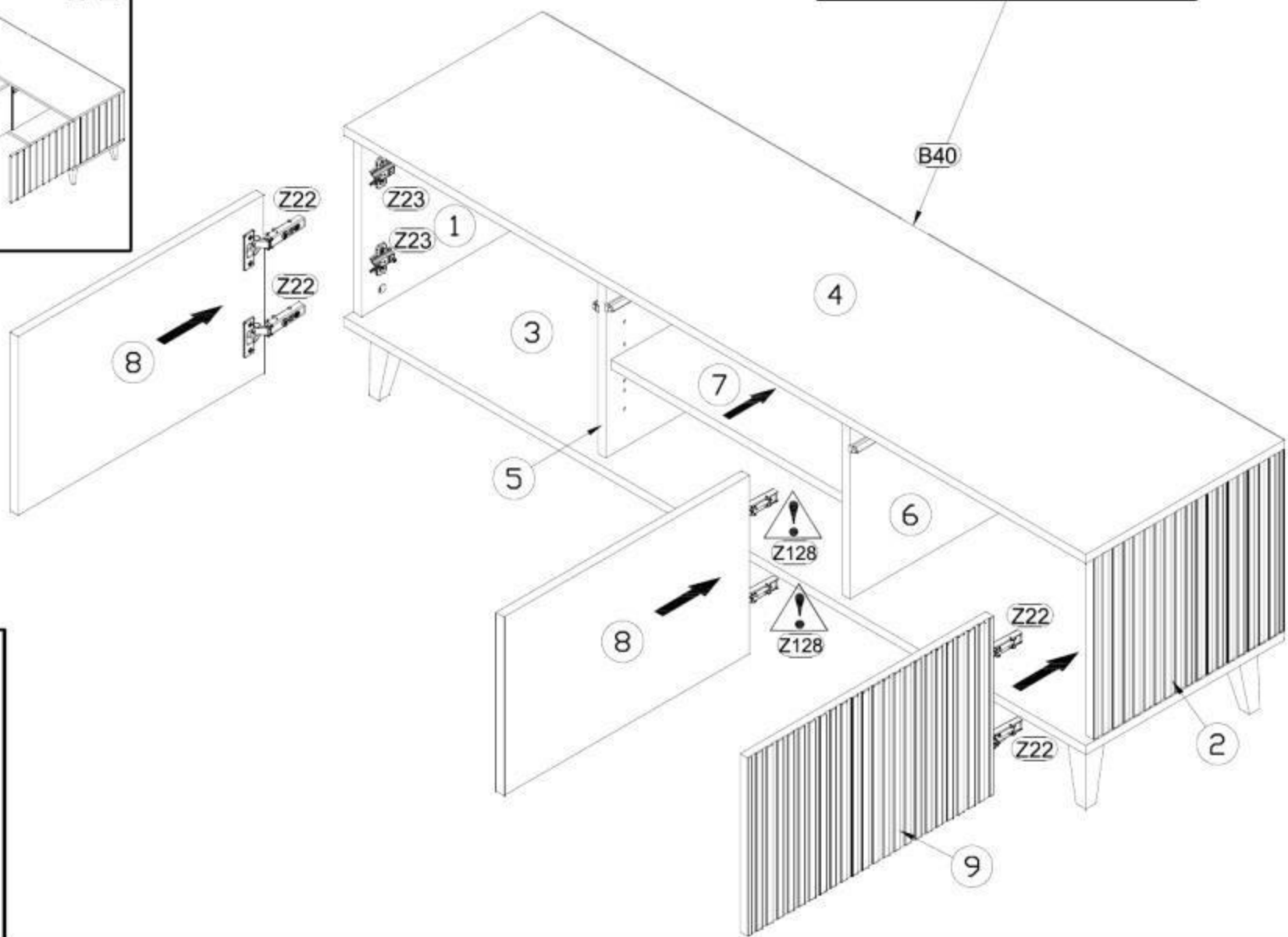
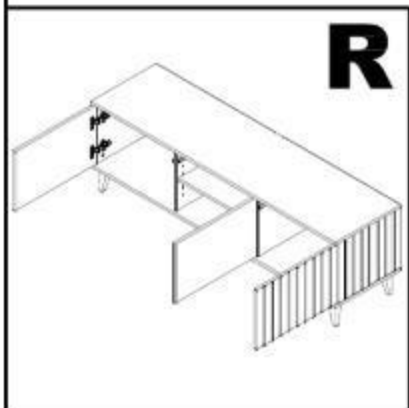
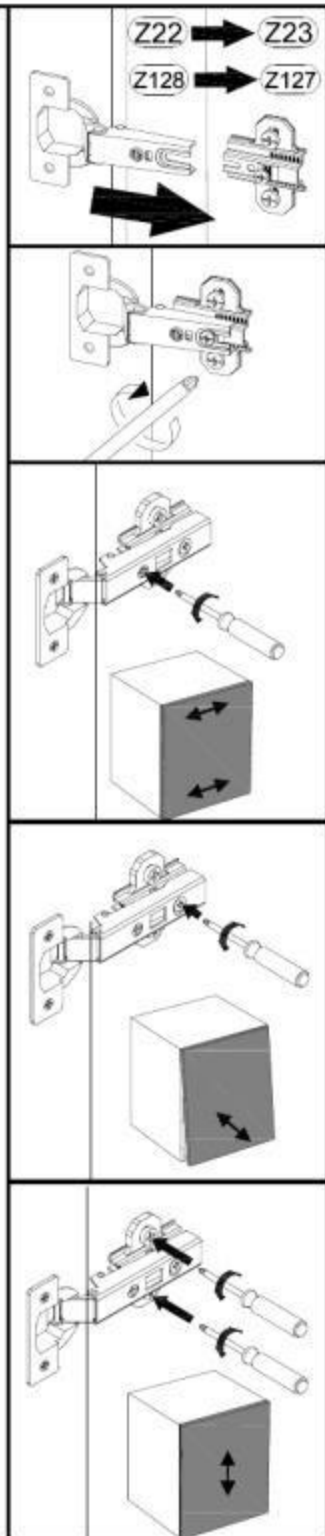
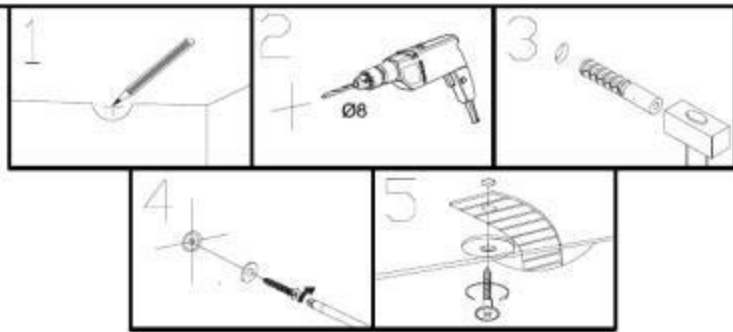

6

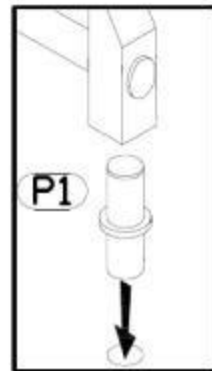
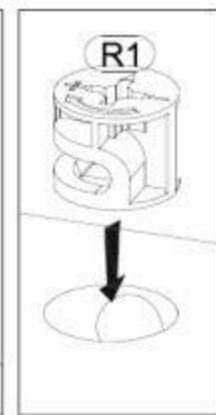
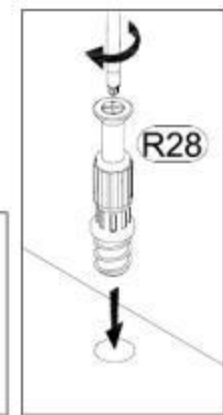
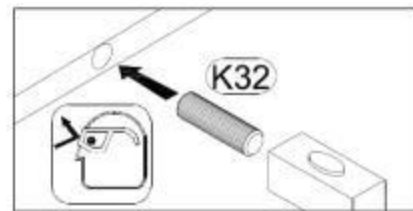
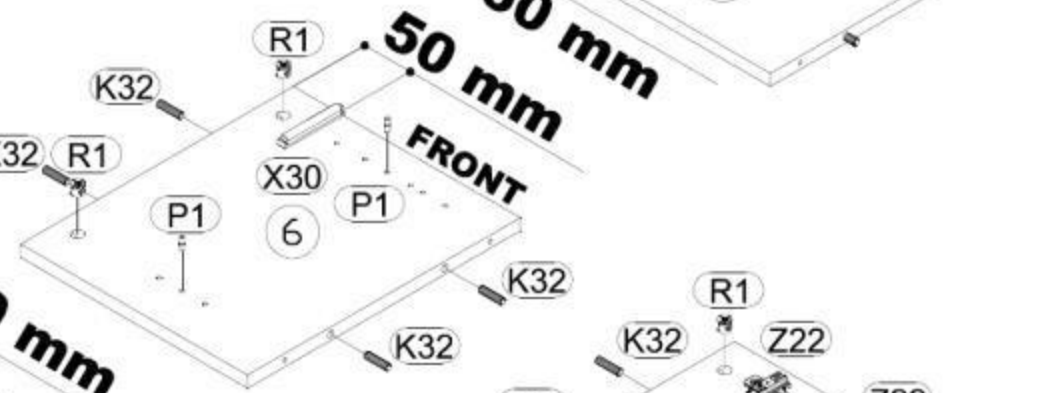
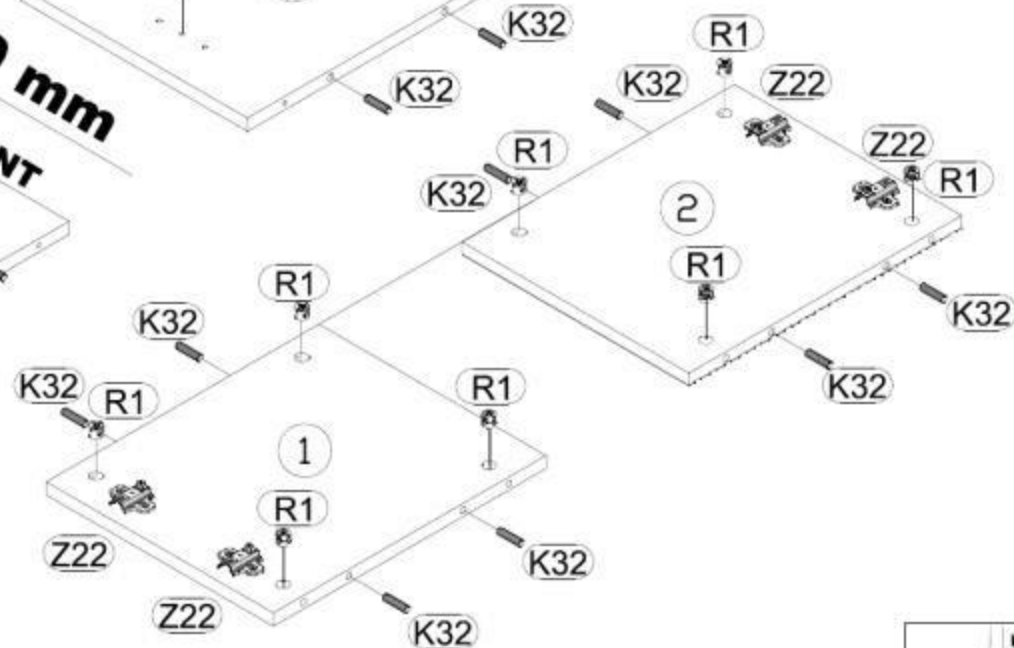
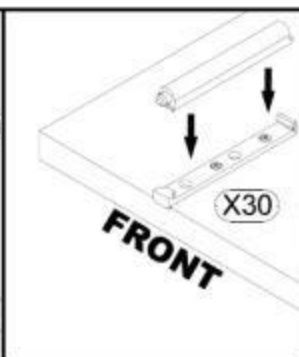
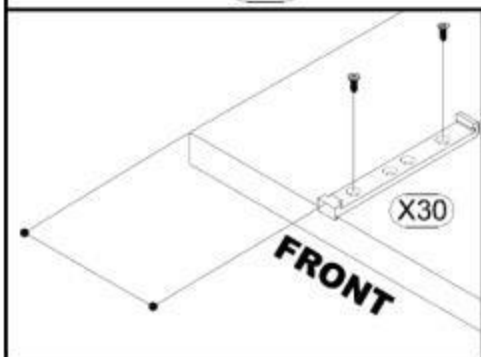
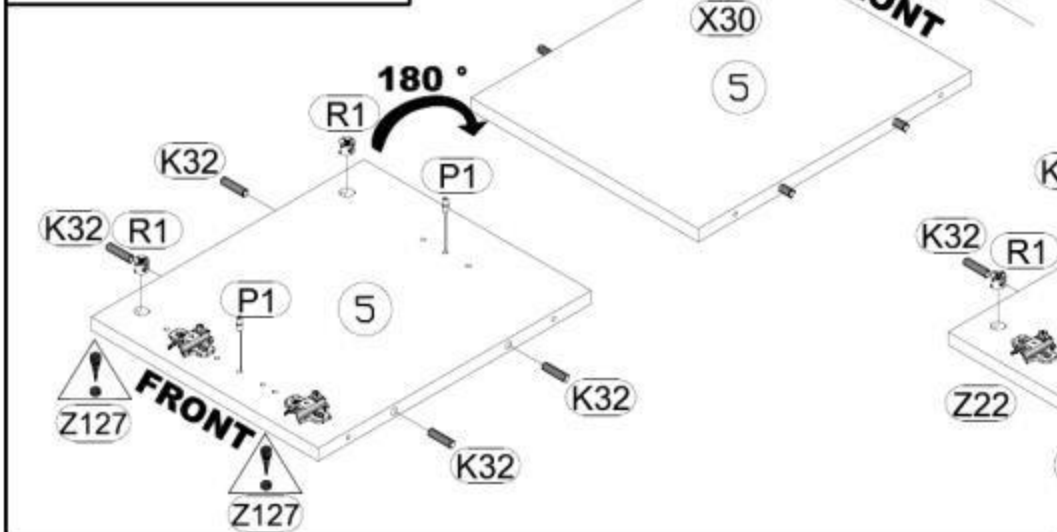
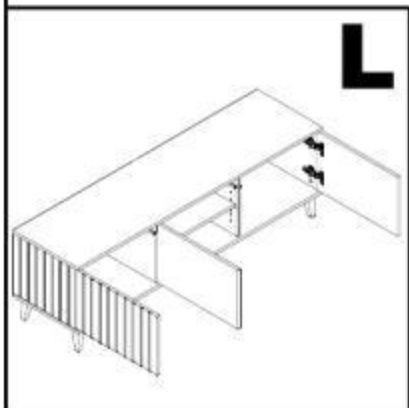

7

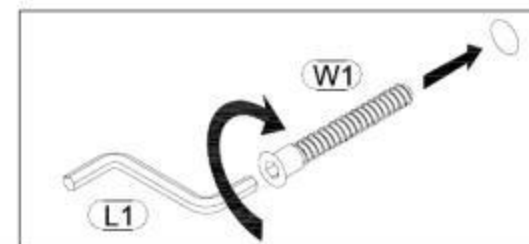
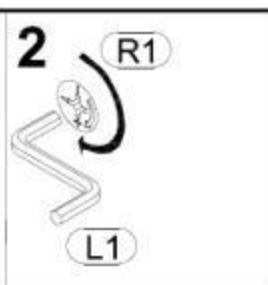
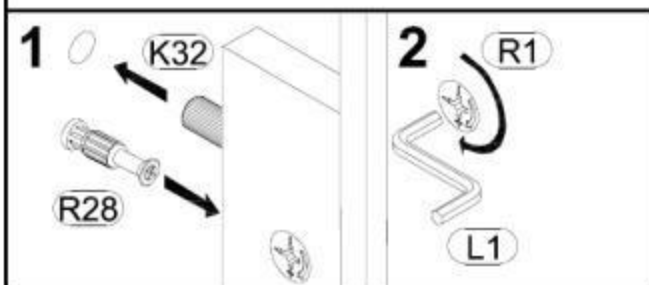
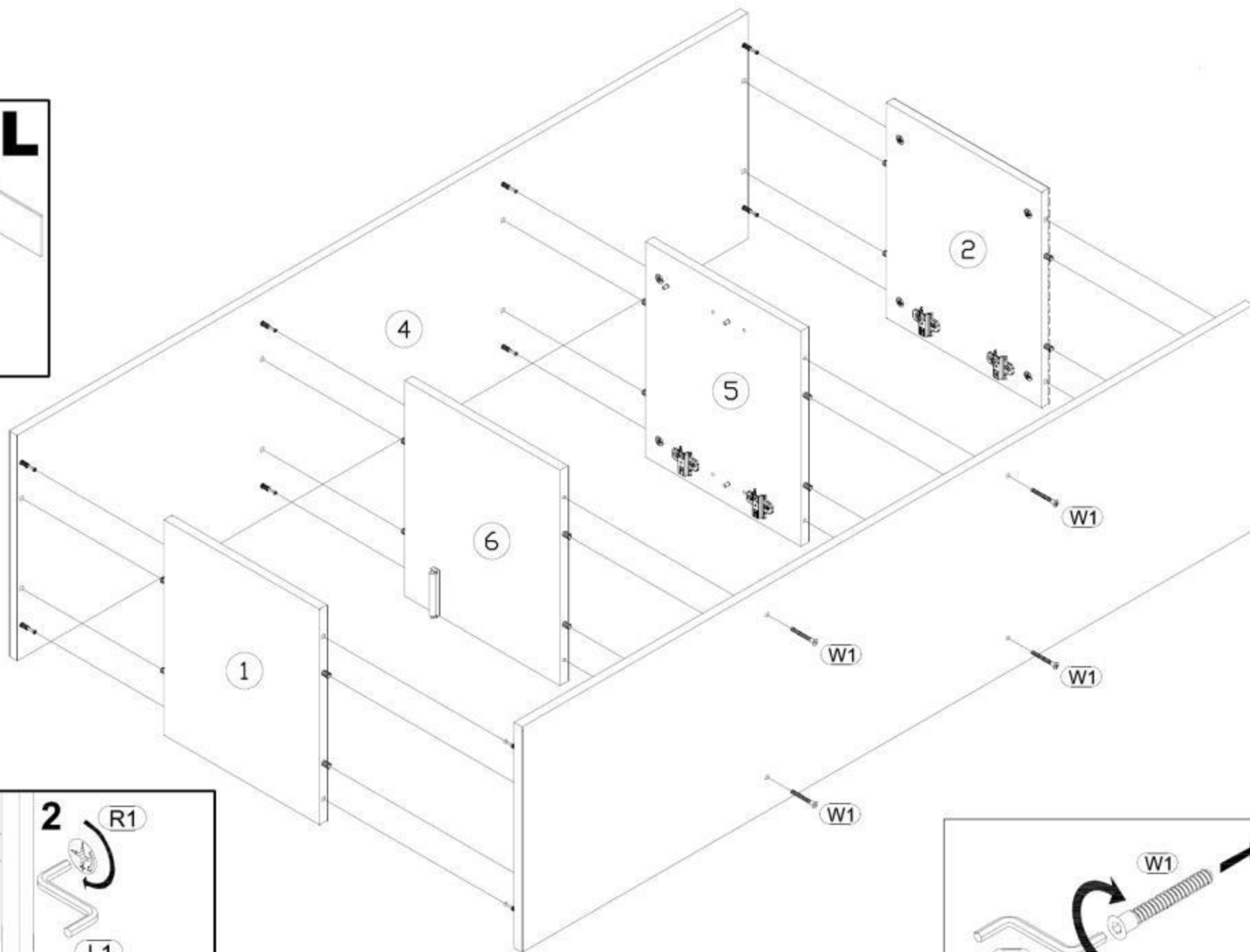
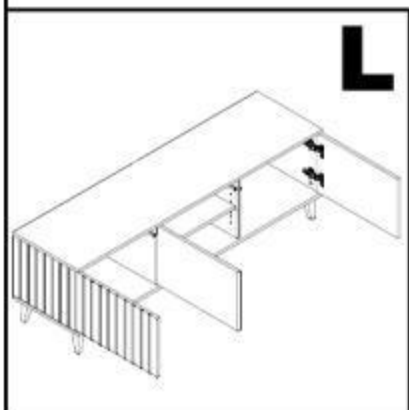

8

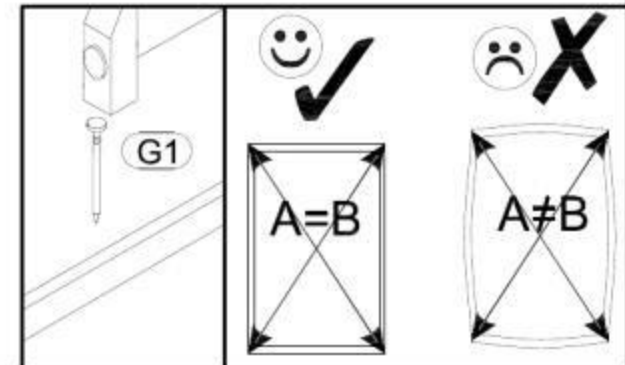
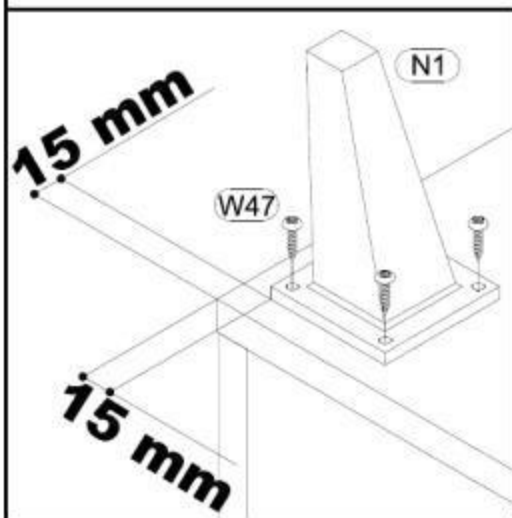
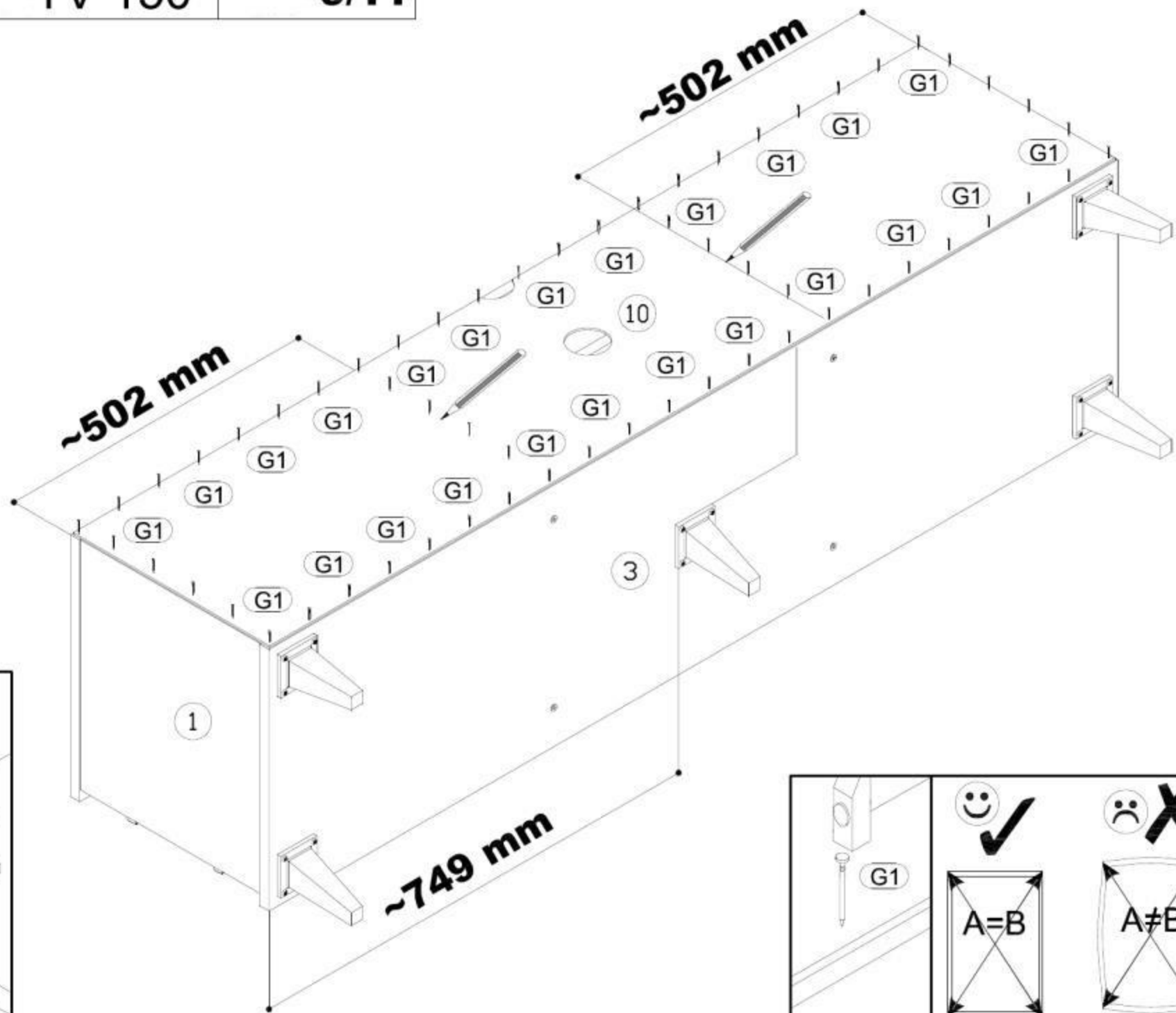
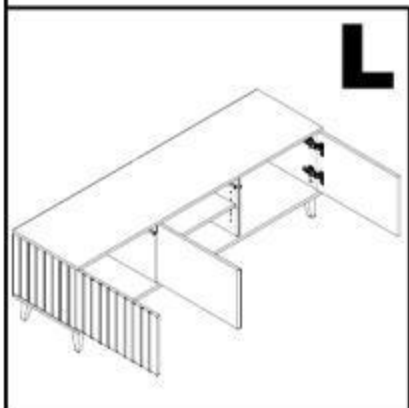

9

