

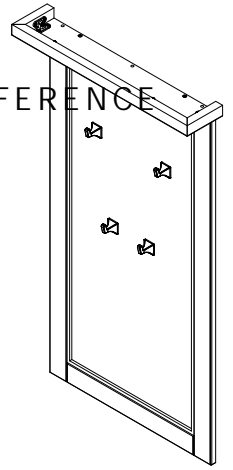

IMPORTANT - READ CAREFULLY - RETAIN FOR FUTURE REFERENCE  
WICHTIG - SORGFÄLTIG LESEN UND AUFBEWAHREN

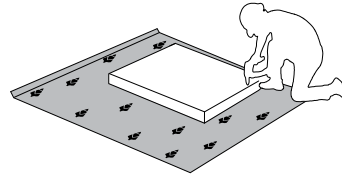

**TARA-CLK**  
LHW - 644x1150x130

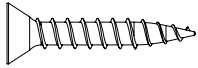
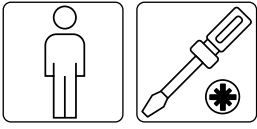
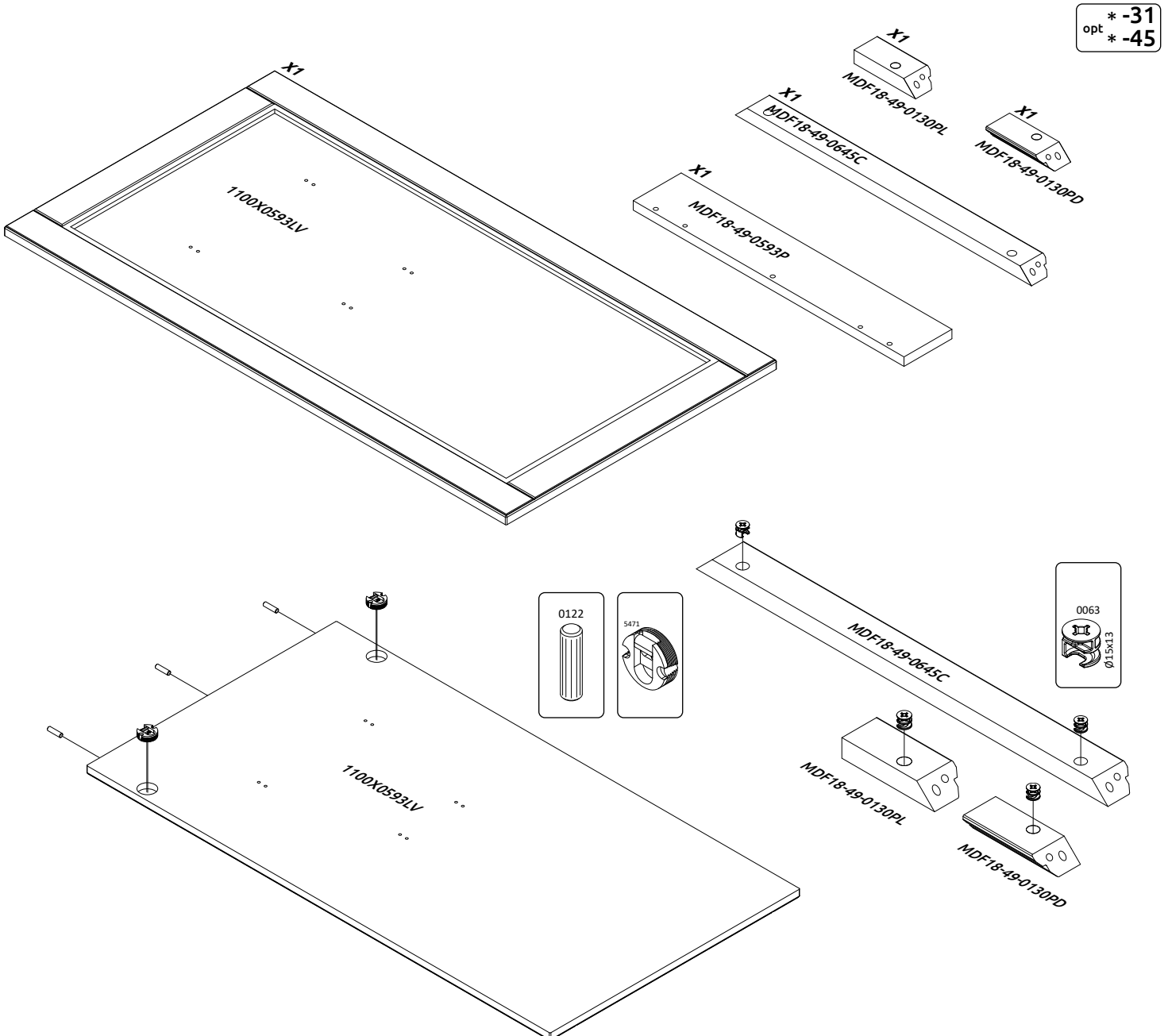
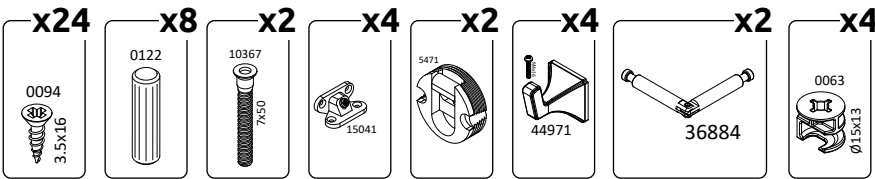

1

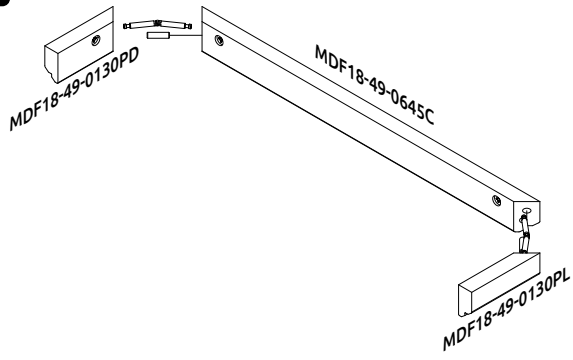

2

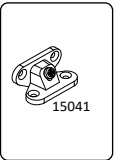
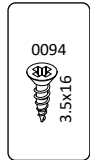
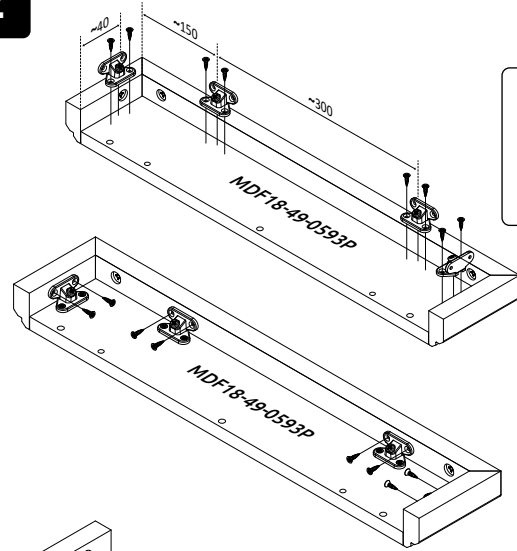

3

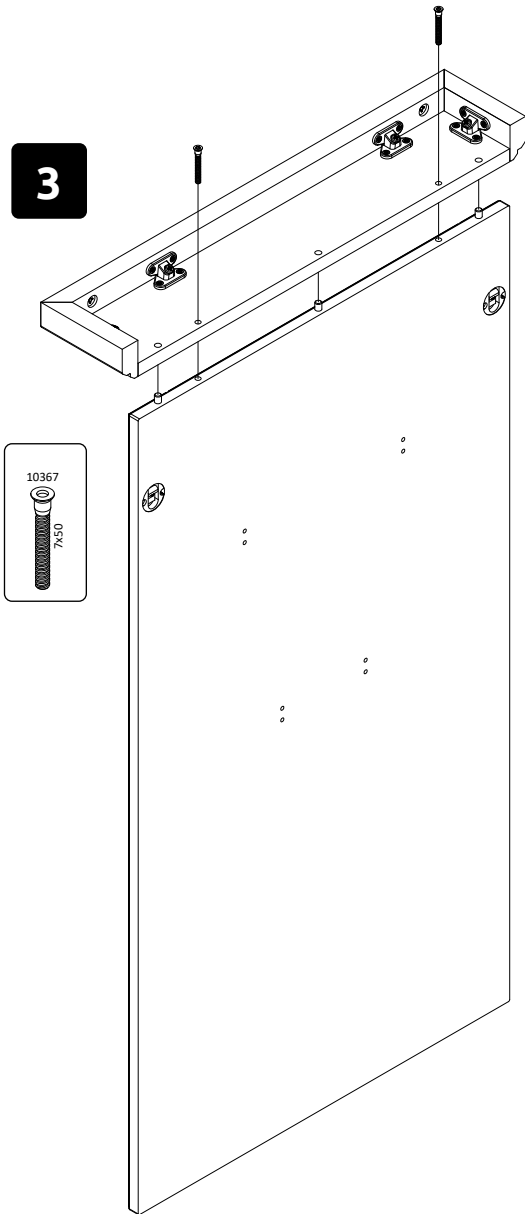

4

