

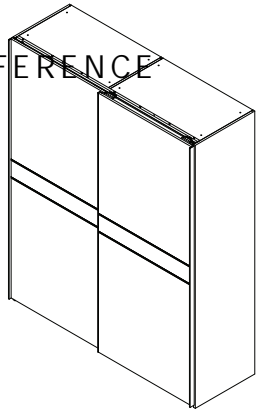

IMPORTANT - READ CAREFULLY - RETAIN FOR FUTURE REFERENCE
 WICHTIG - SORGFÄLTIG LESEN UND AUFBEWAHREN

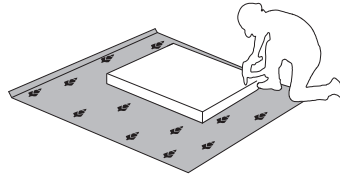

PK181/PN
 LWH - 1818x611x2236

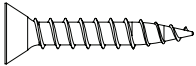
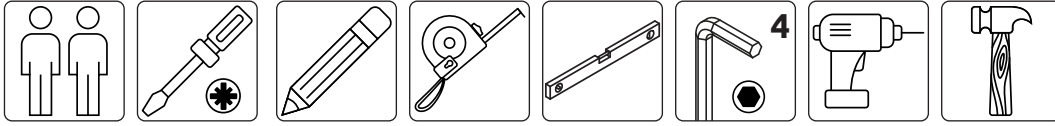

x24 2149 	x16 0063 Ø15x13 	x8 0064 Ø8x24 	x24 16535 	x16 0102 	x16 EKSK4-BE 	x2 2114 4x35 	x56 0094 3.5x16 	x60 31777 4.2x16 	x12 0096 4x18 	
x2 7004 	x4 30812 	x2 36918 	x2 26102 	x1 46944 	x1 46947 	x1 0113 GLUE 				
x1 46950 	x6 NPVC75 	x1 46953 								
x20 CEP8 	x24 FAH-16 	x30 0122 	x4 32245 							
x4 0104 	x2 10397 									
x24 36894 										

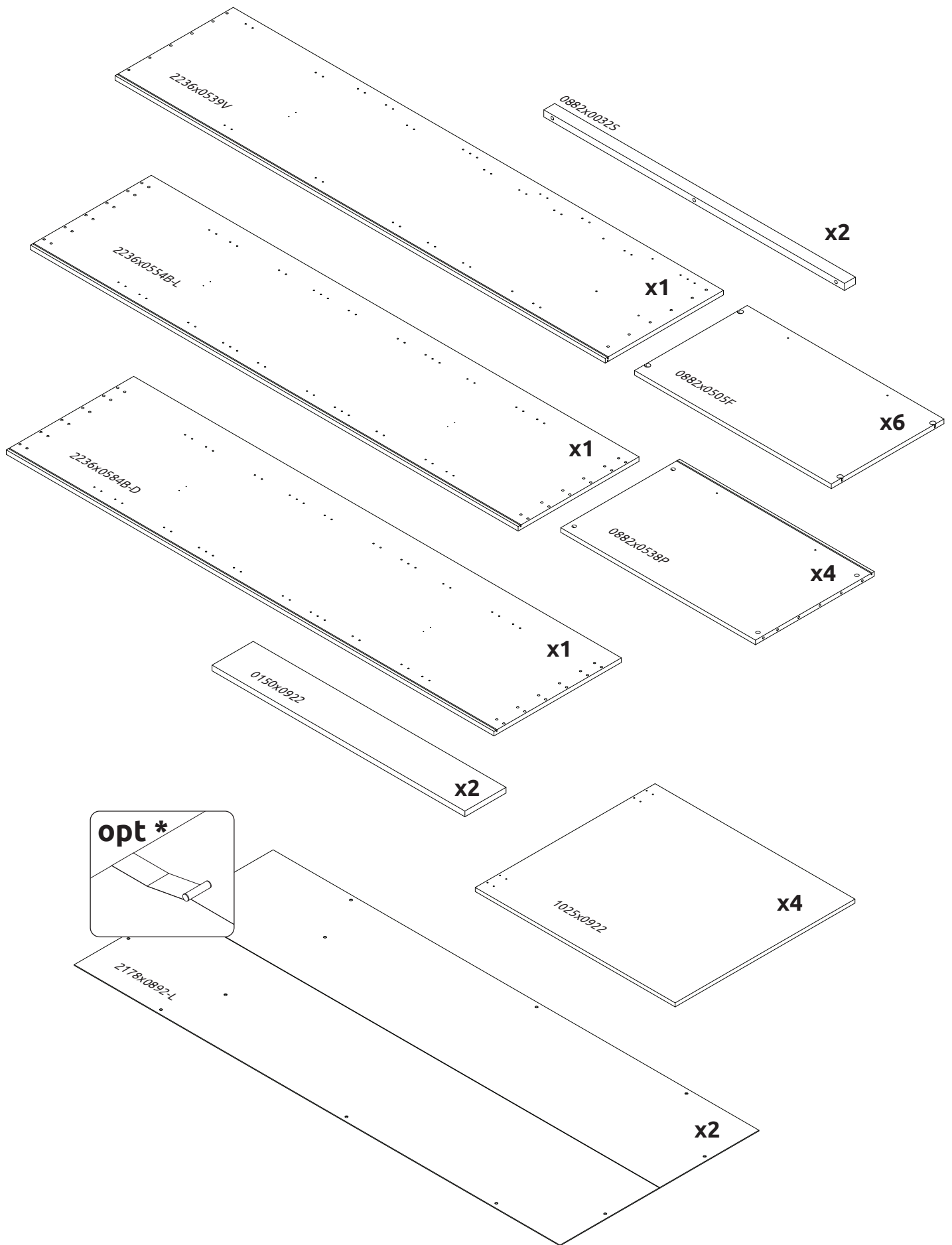

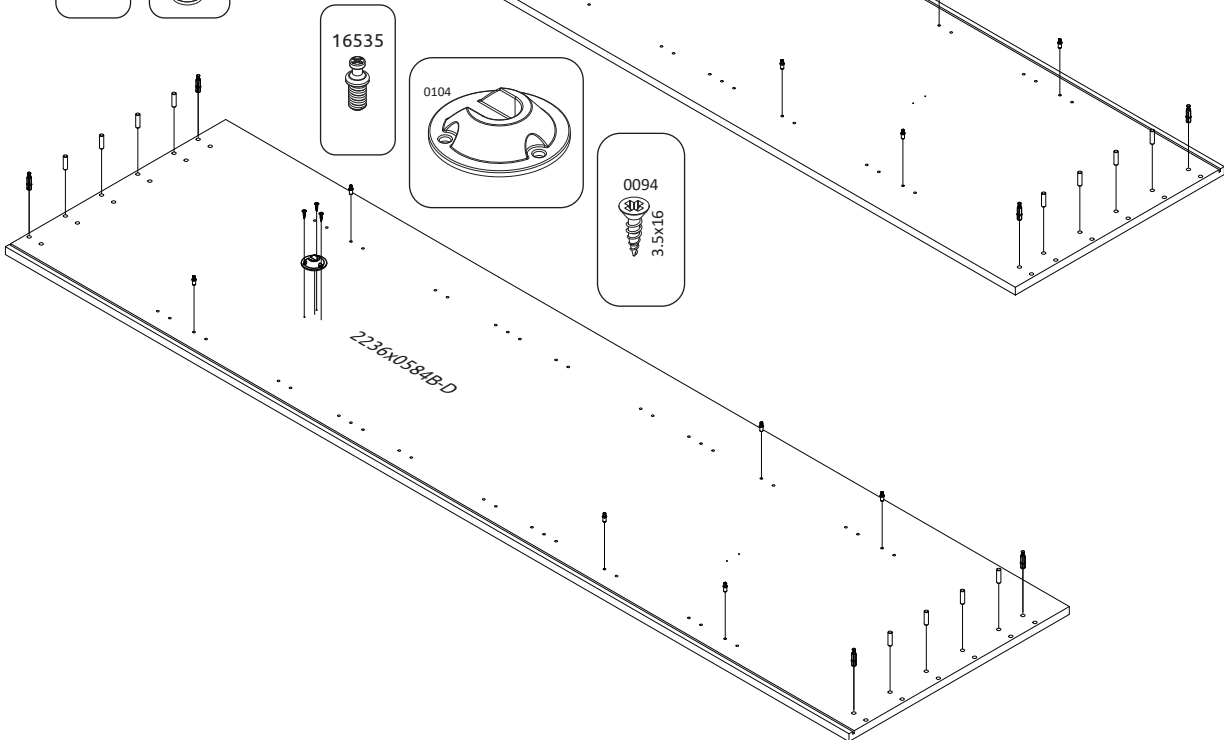
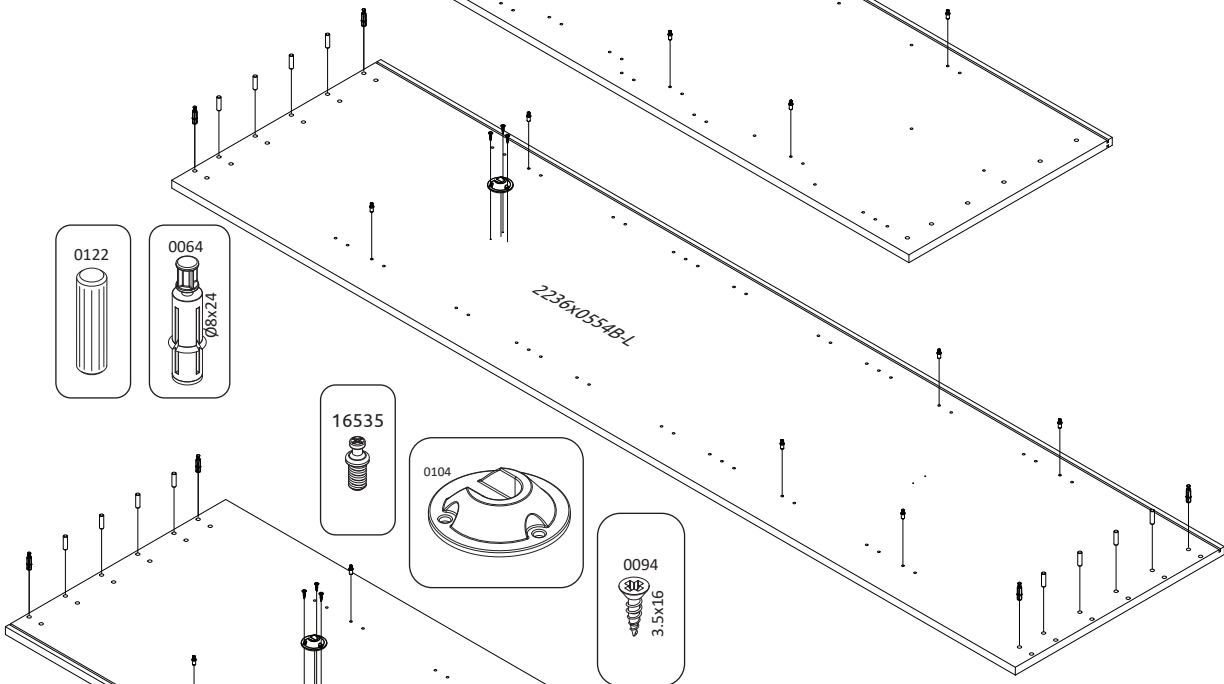
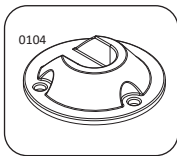
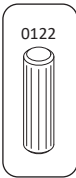
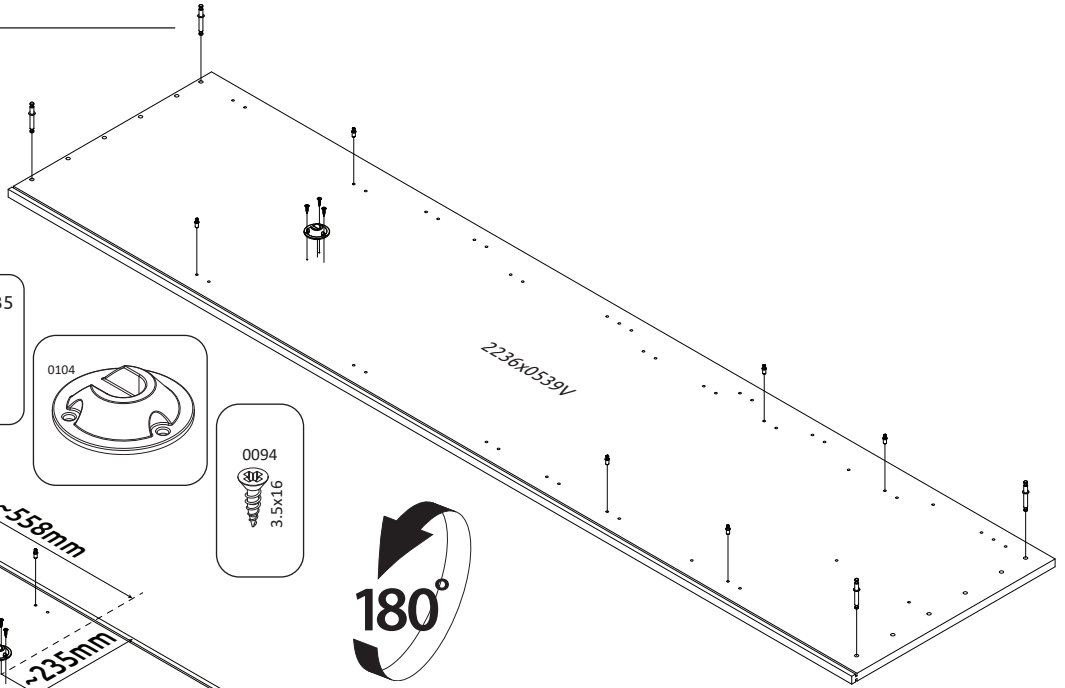
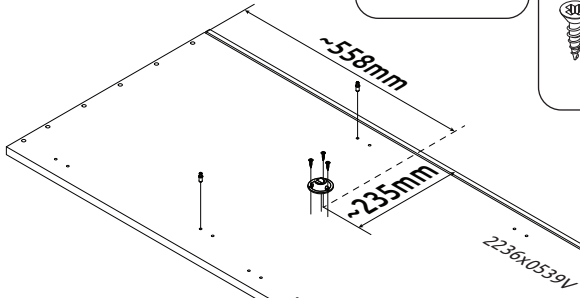
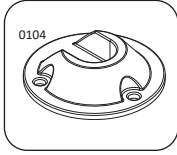
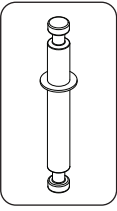
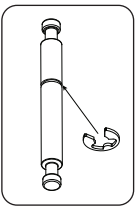
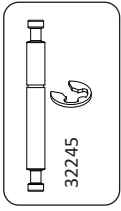

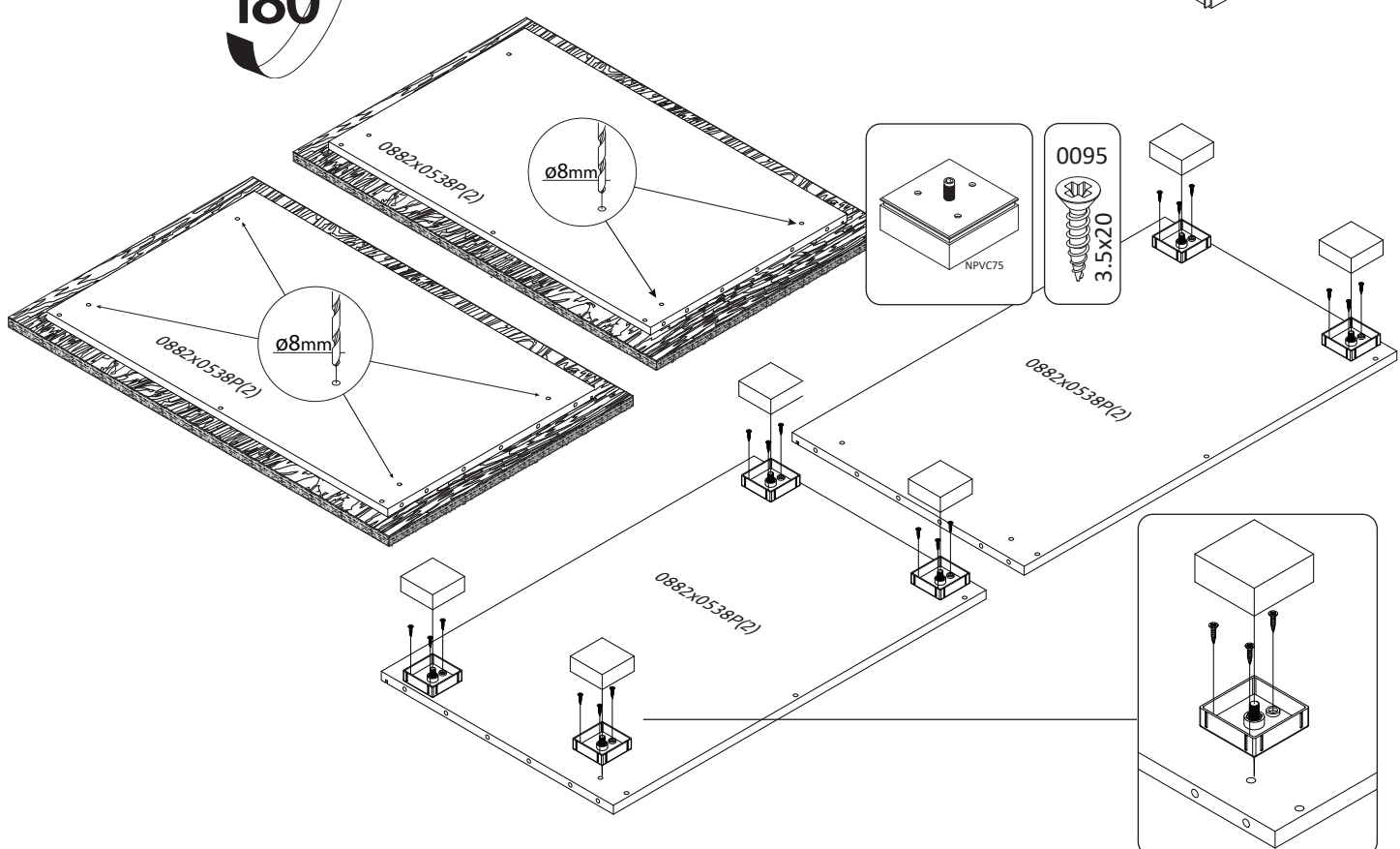
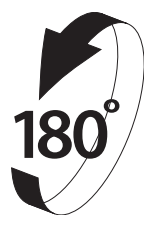
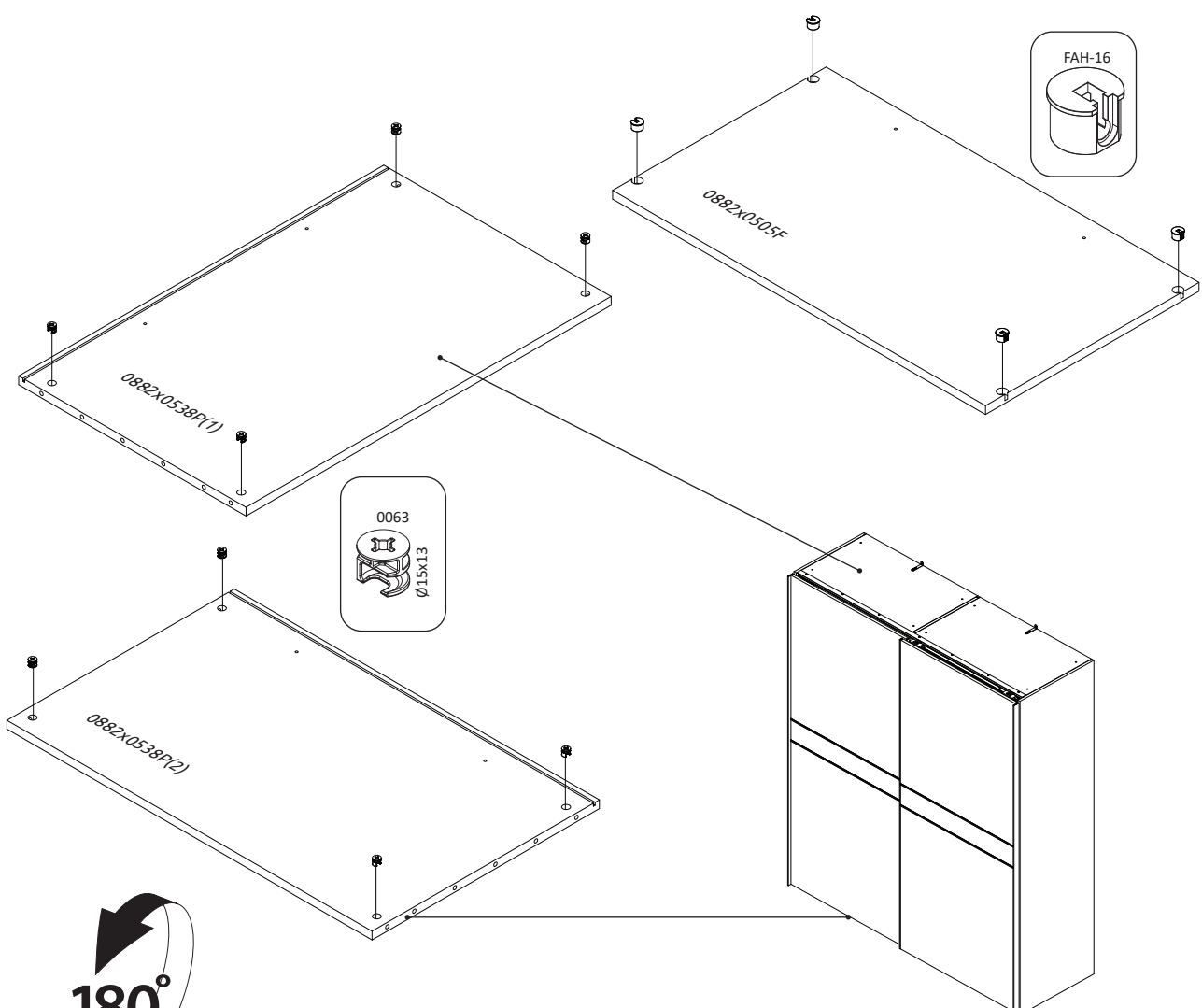

1

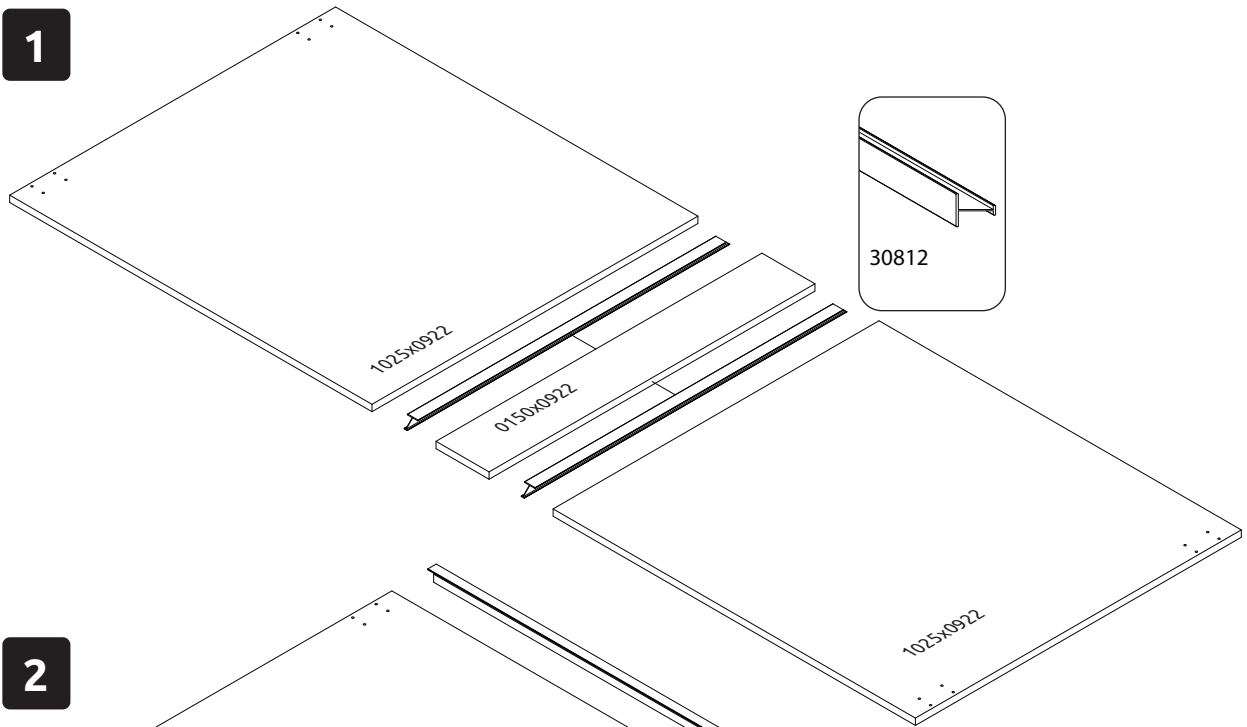

2

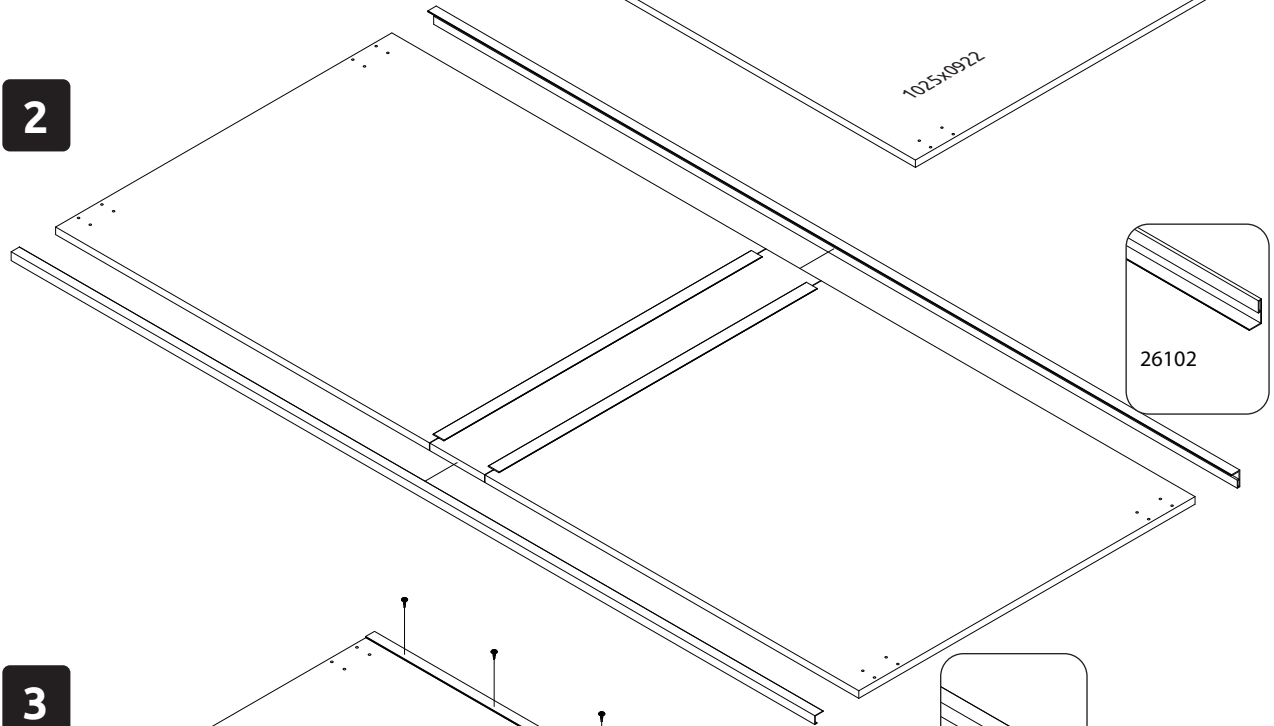

3

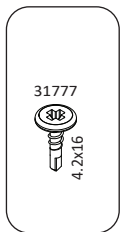
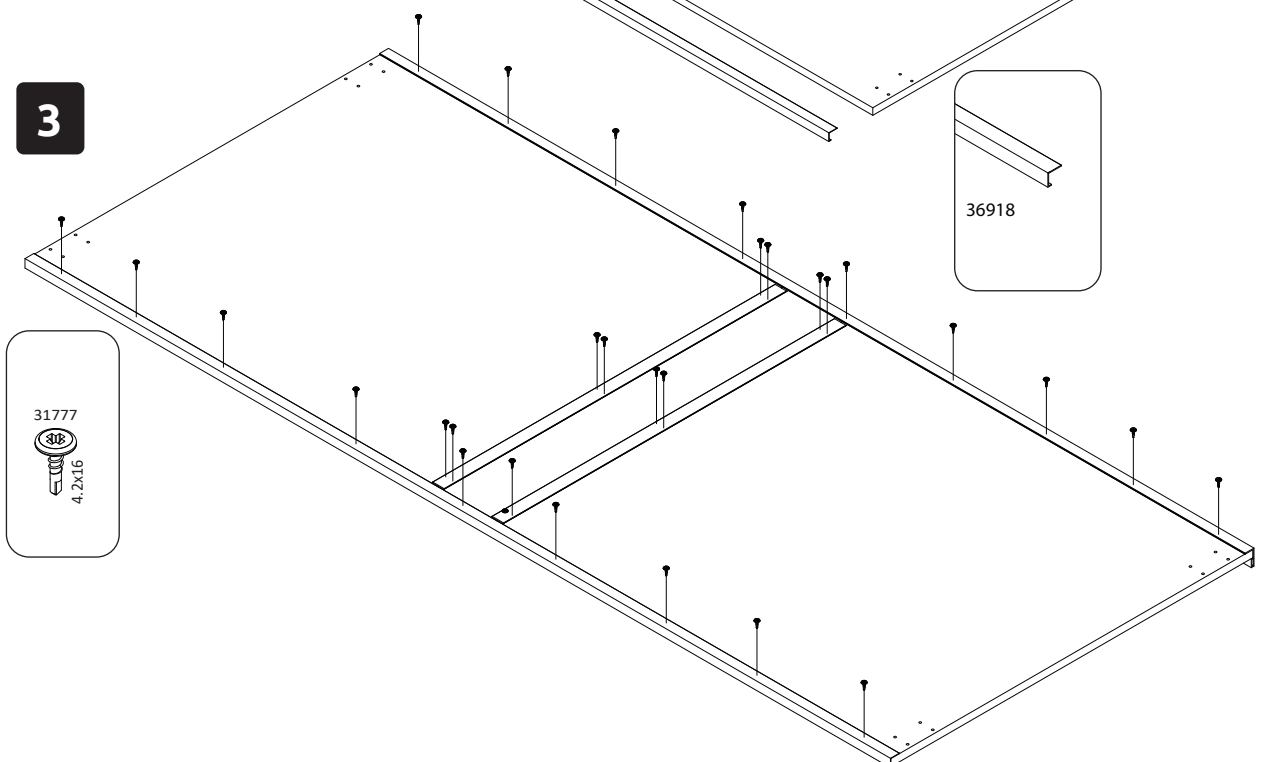

4

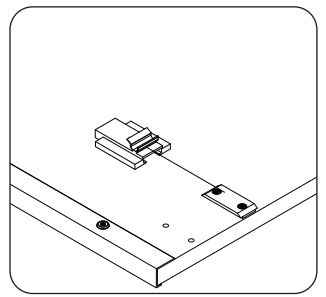
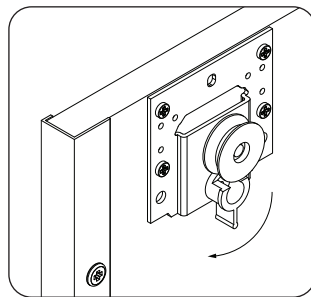
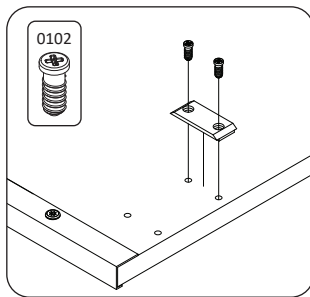
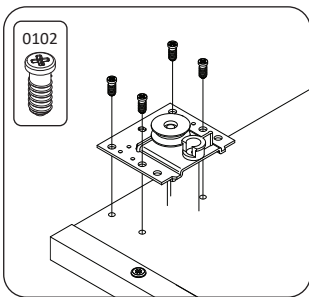
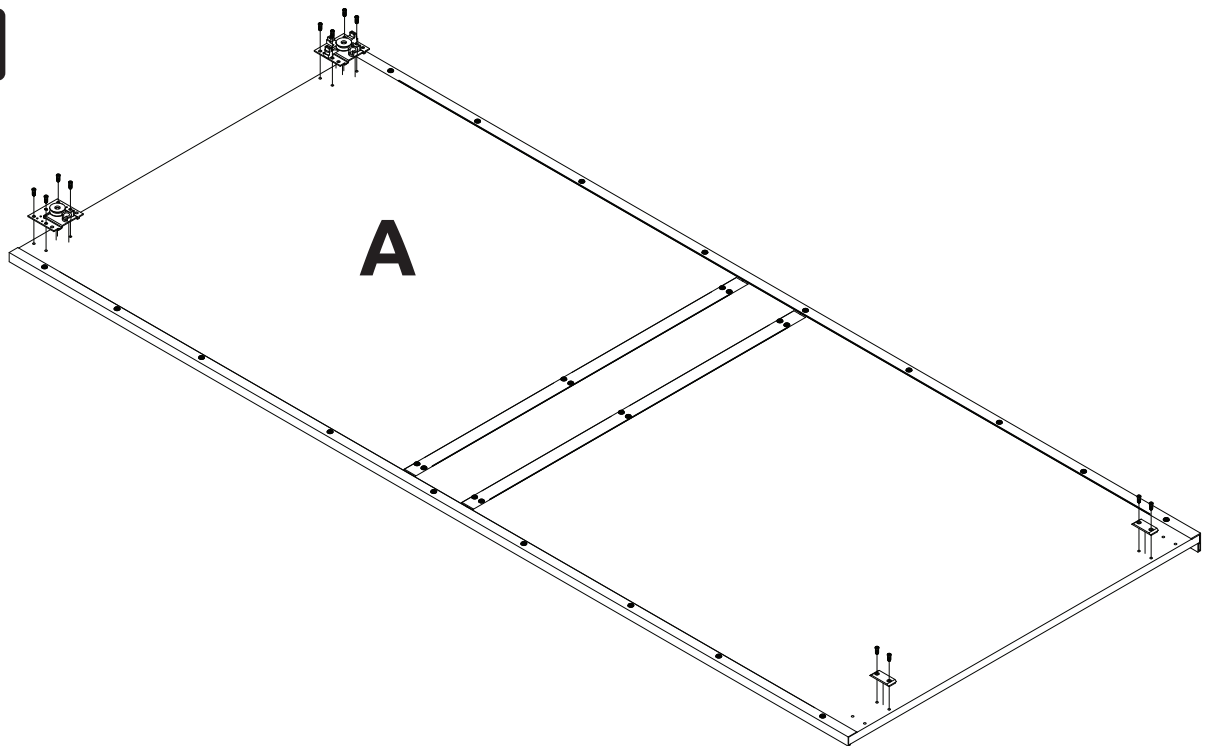

5

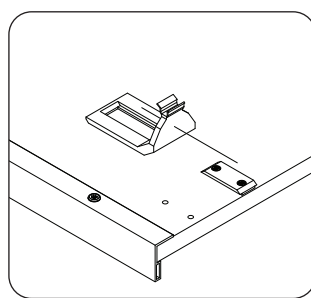
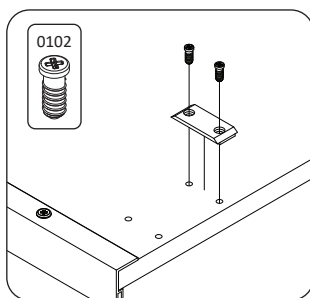
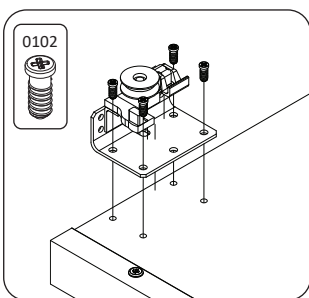
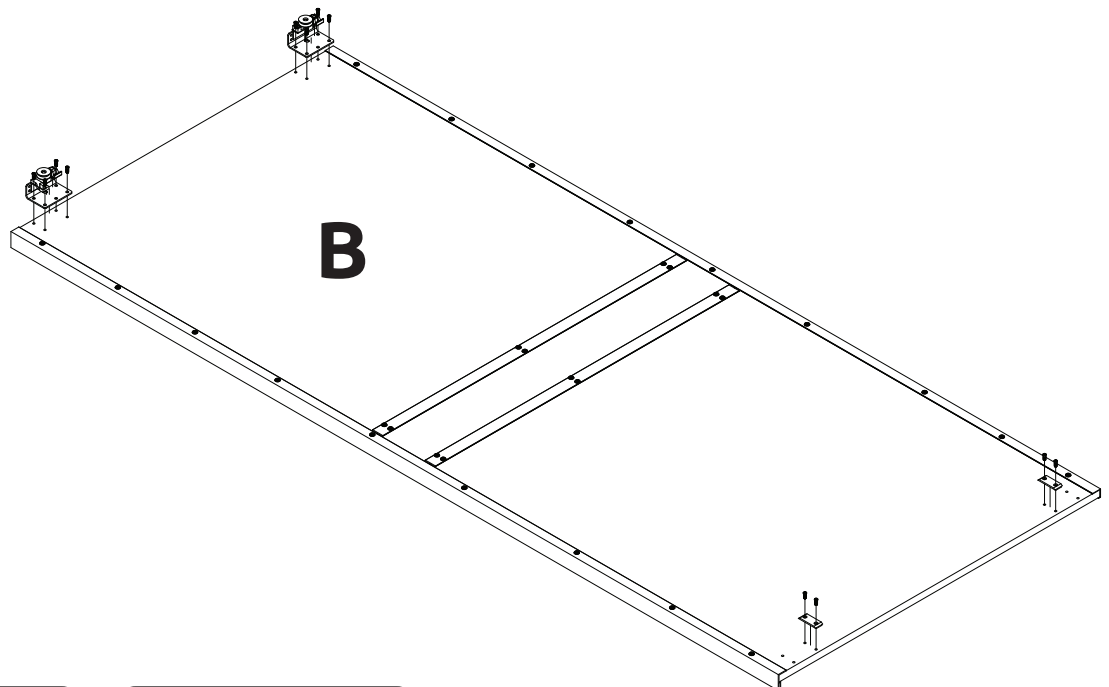

6

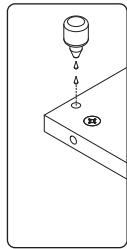
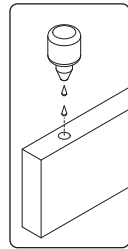
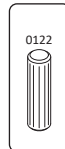
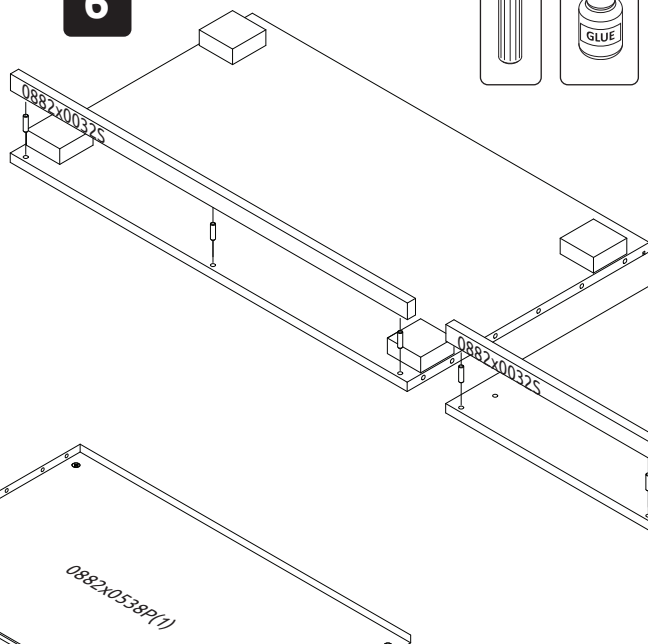

7

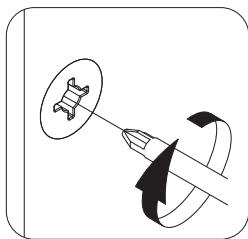
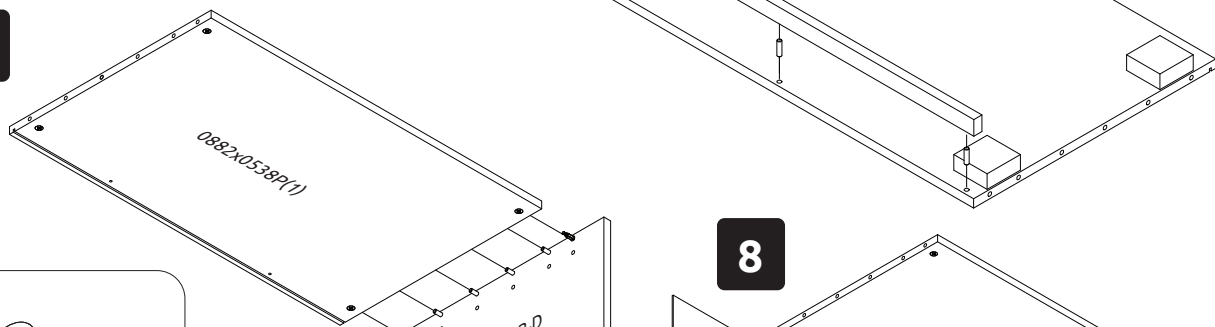

8

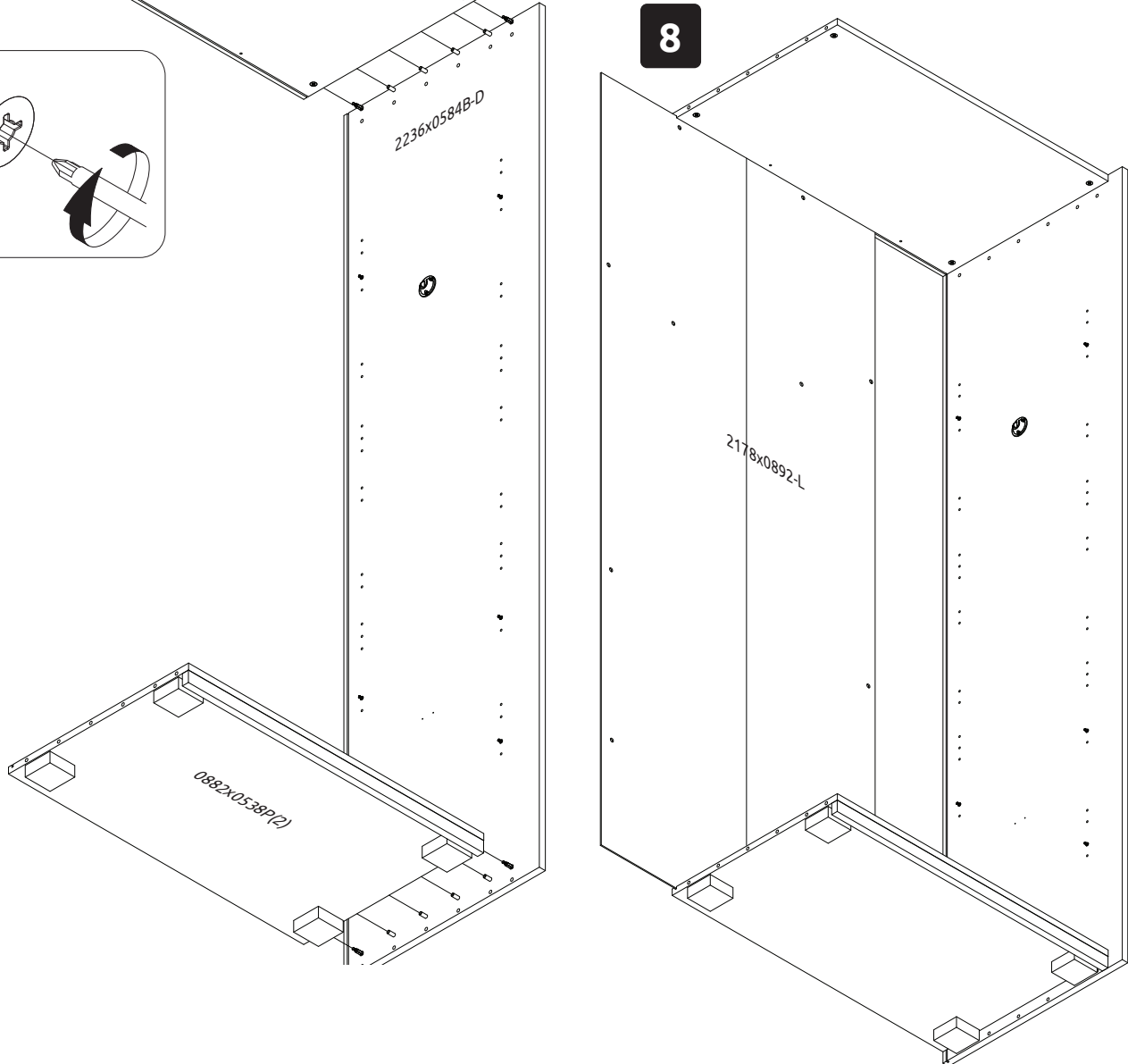

9

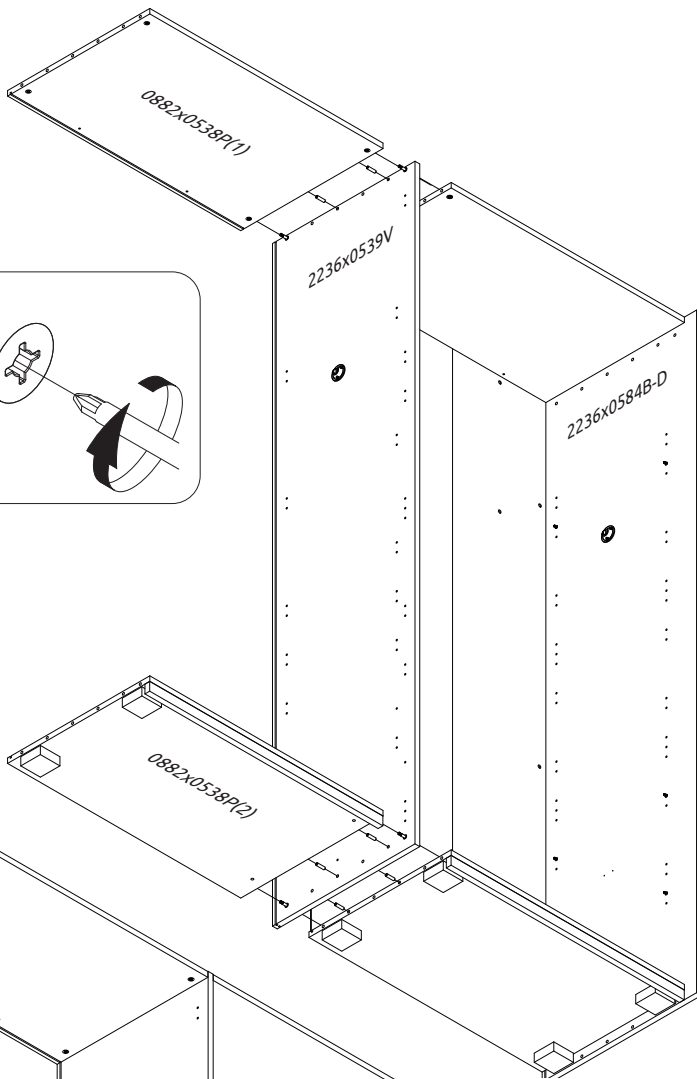
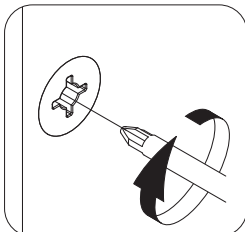
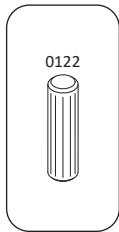

10

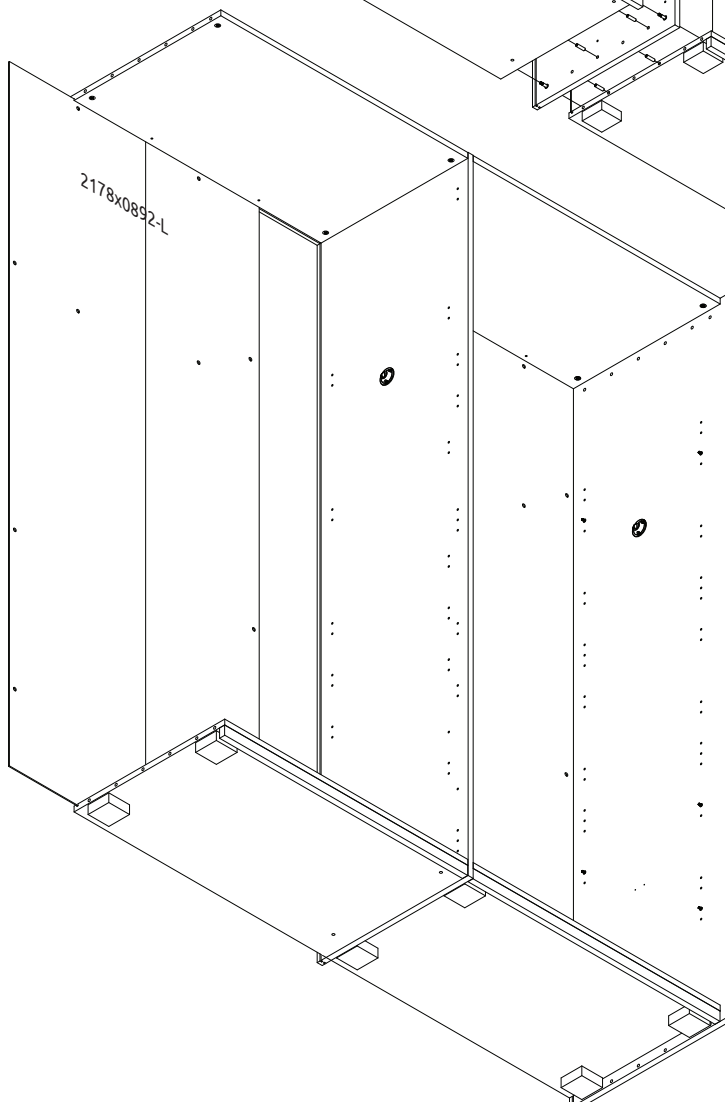

11

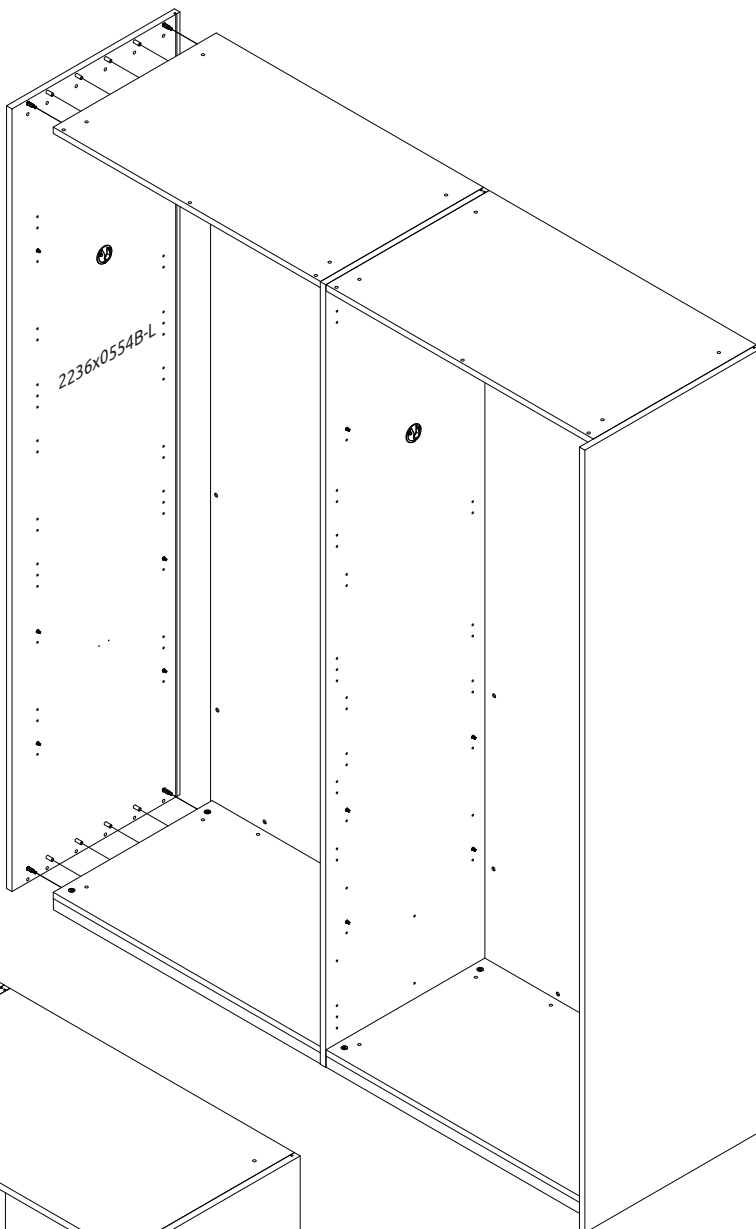
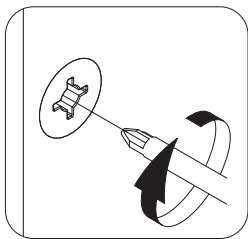

12

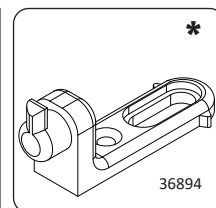
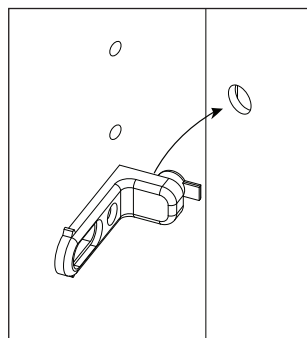
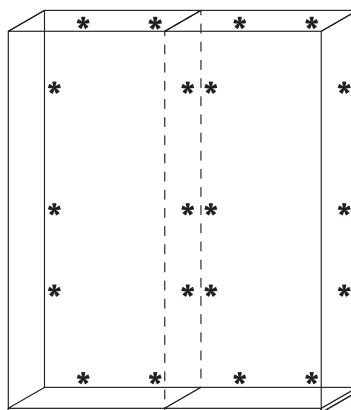
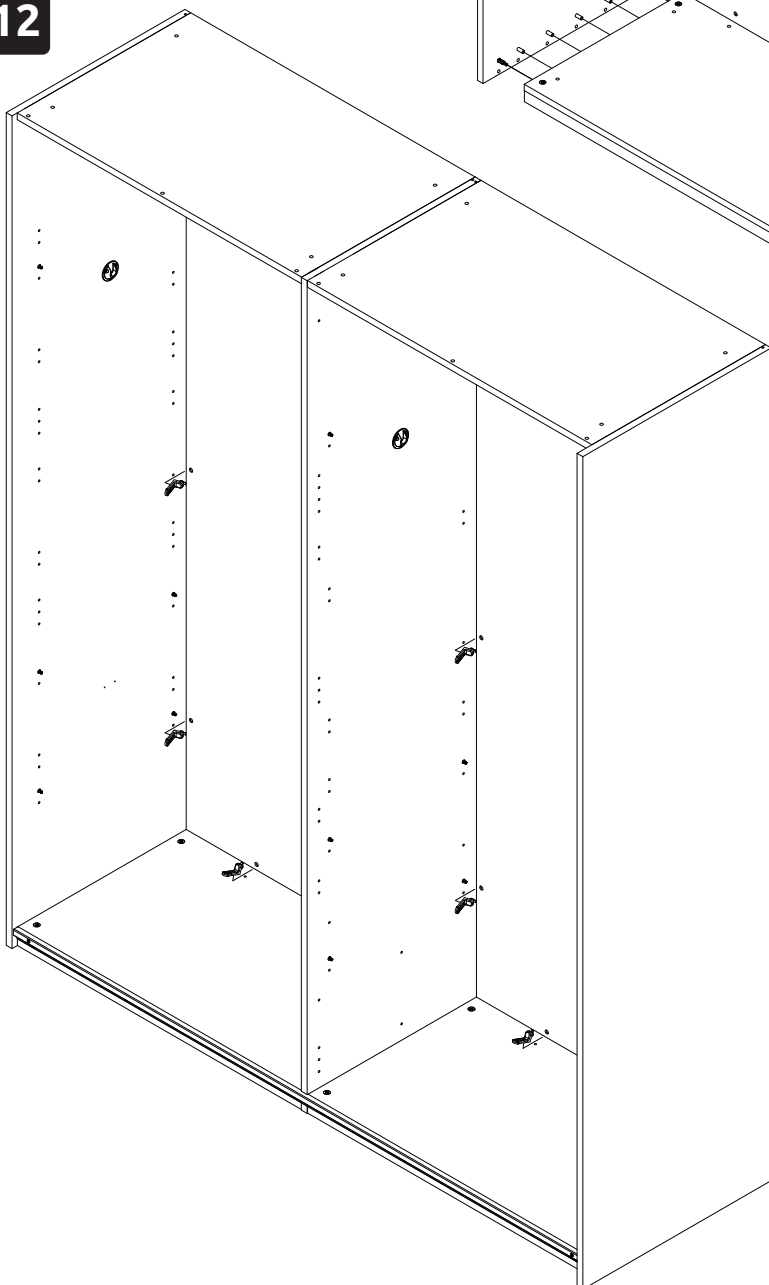

12

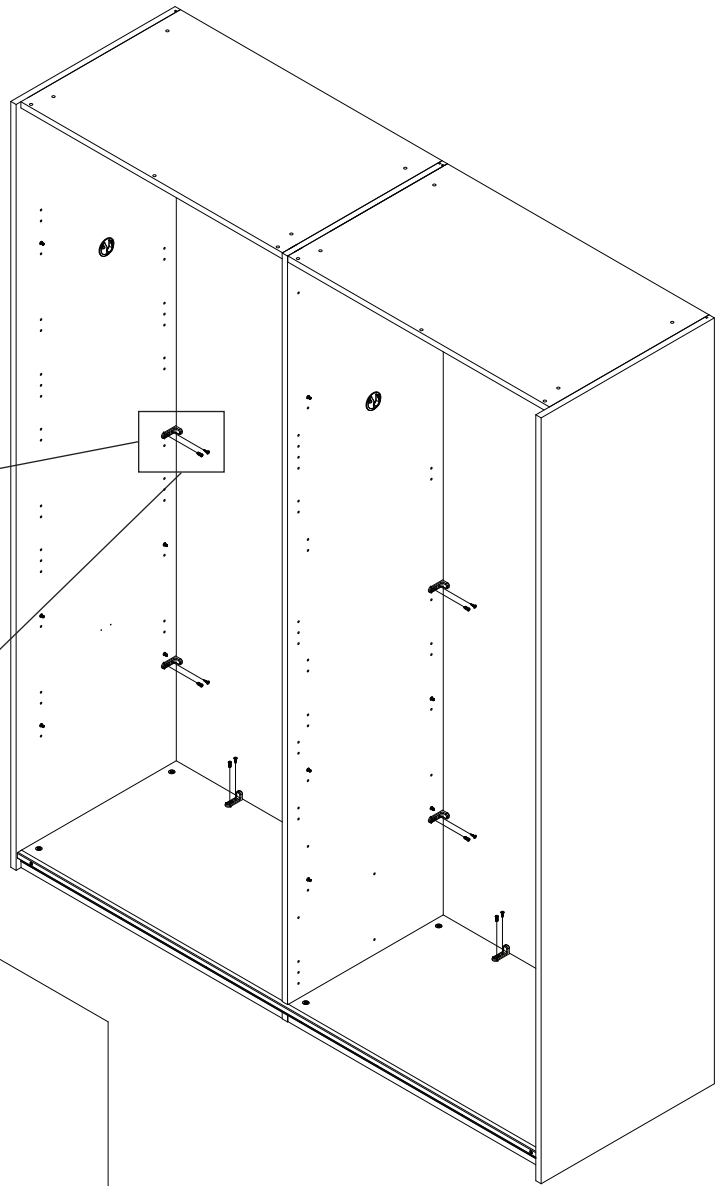
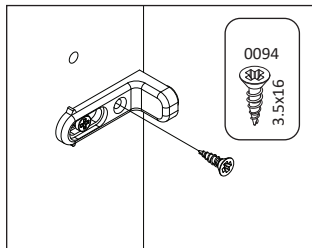
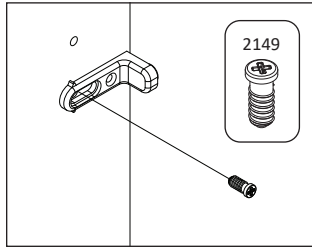
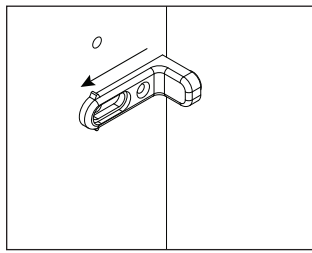

13

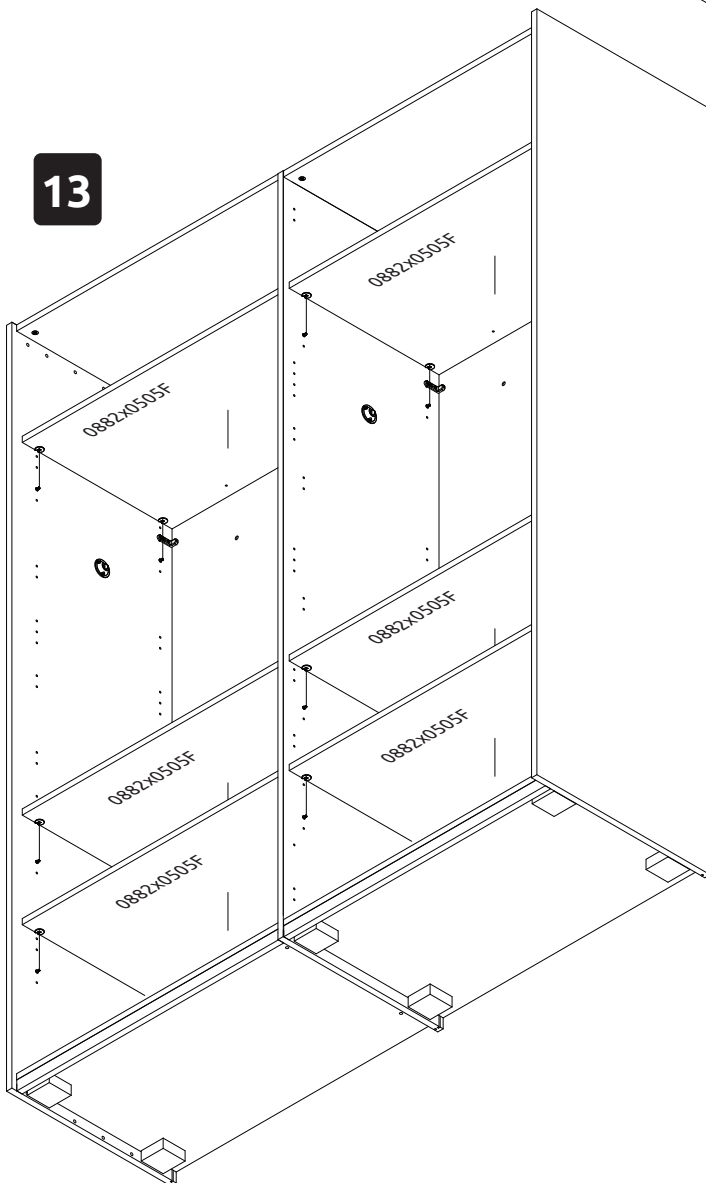

14

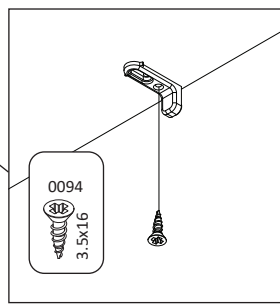
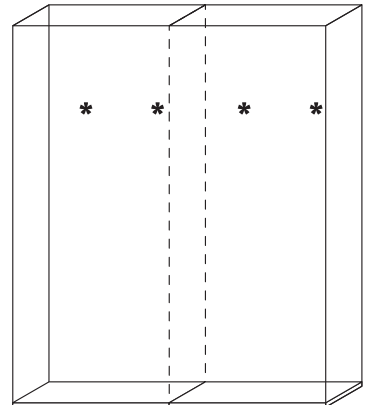
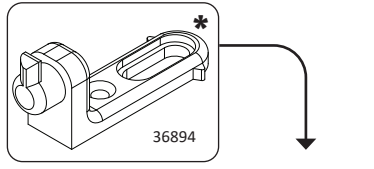
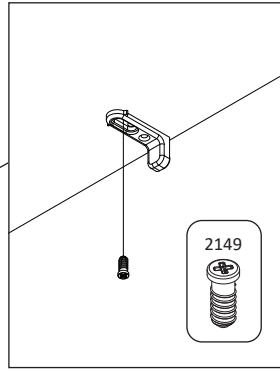
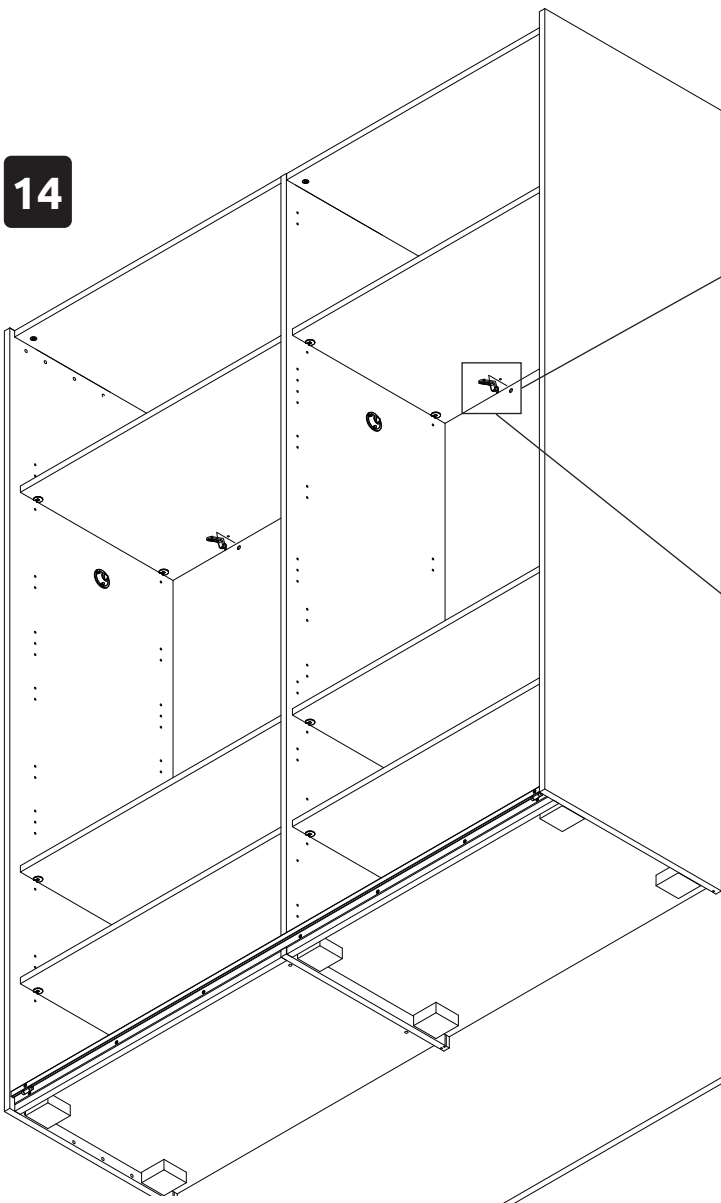

15

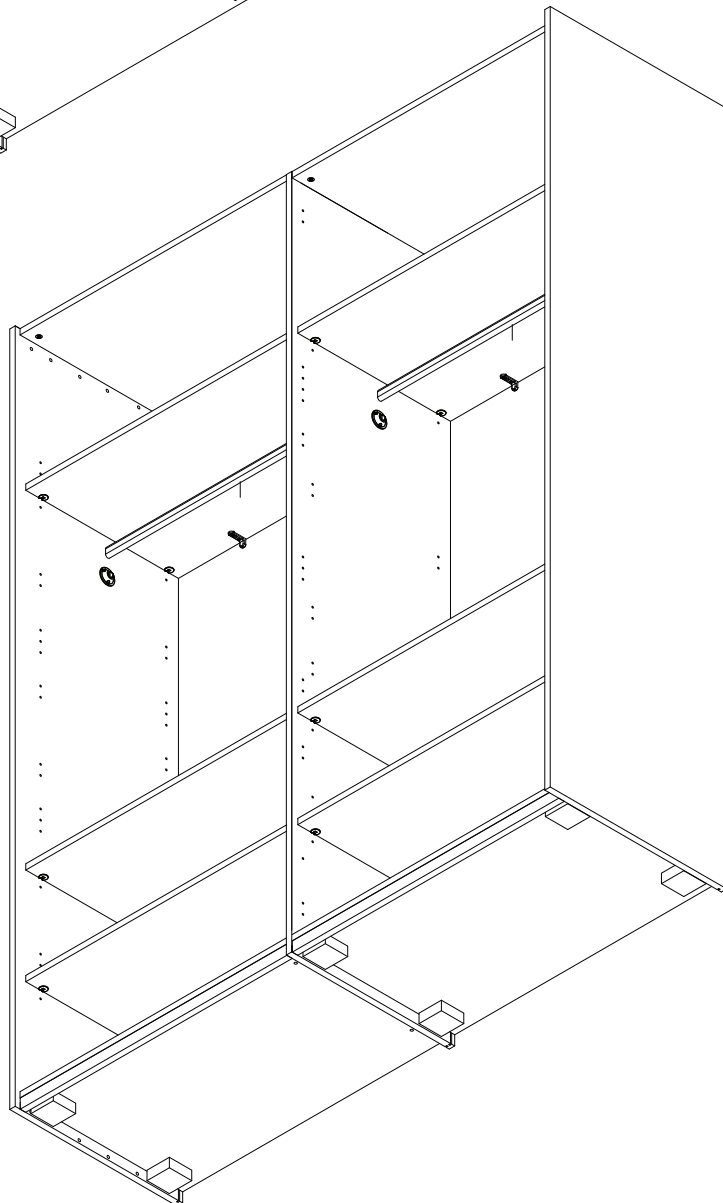
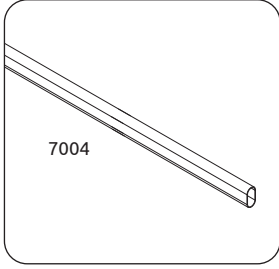

16

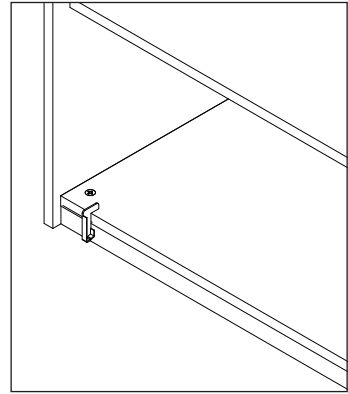
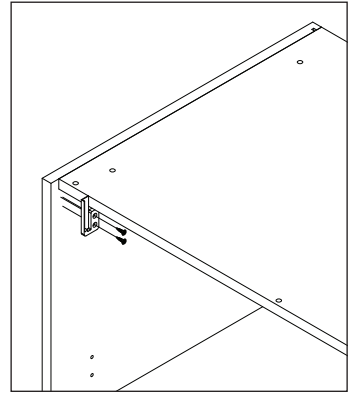
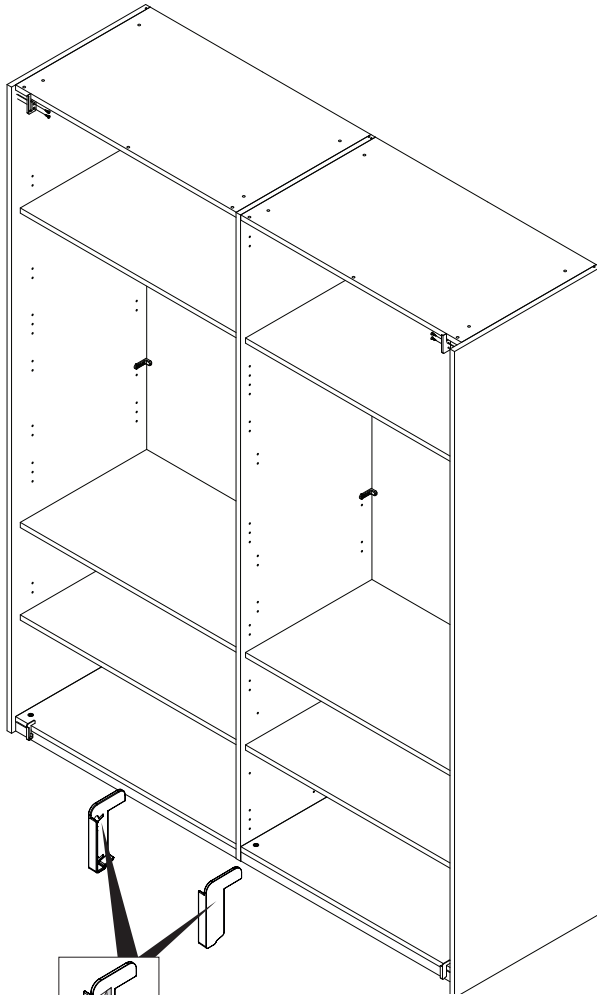
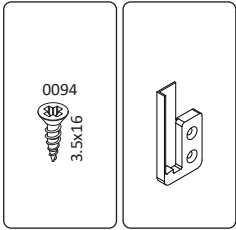

17

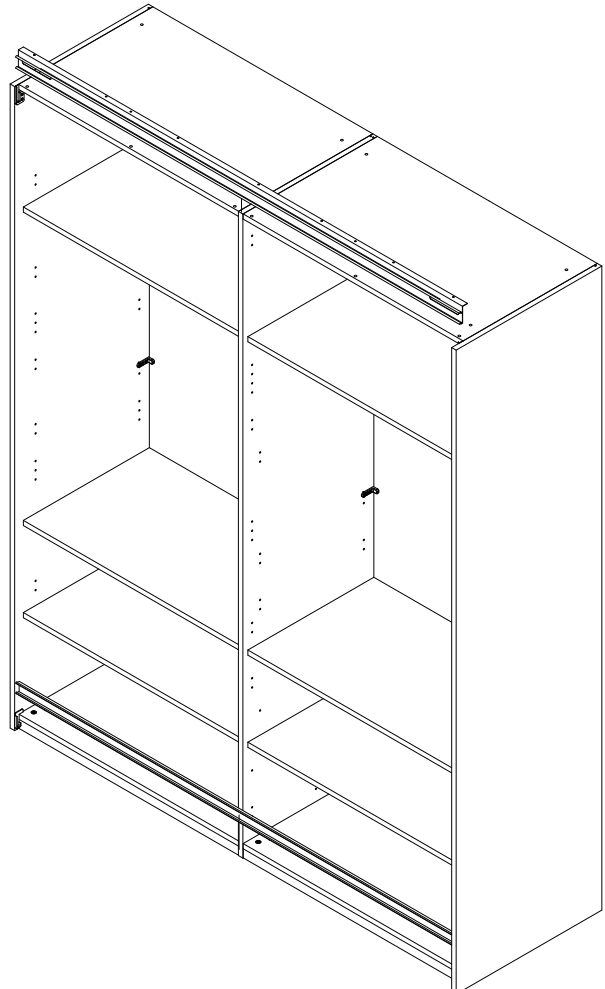

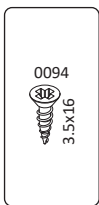
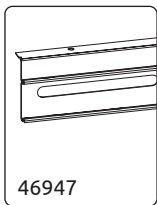

18

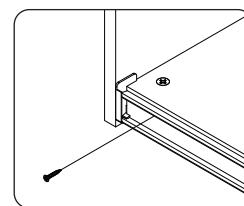
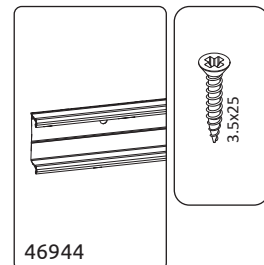
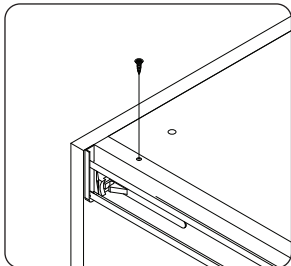
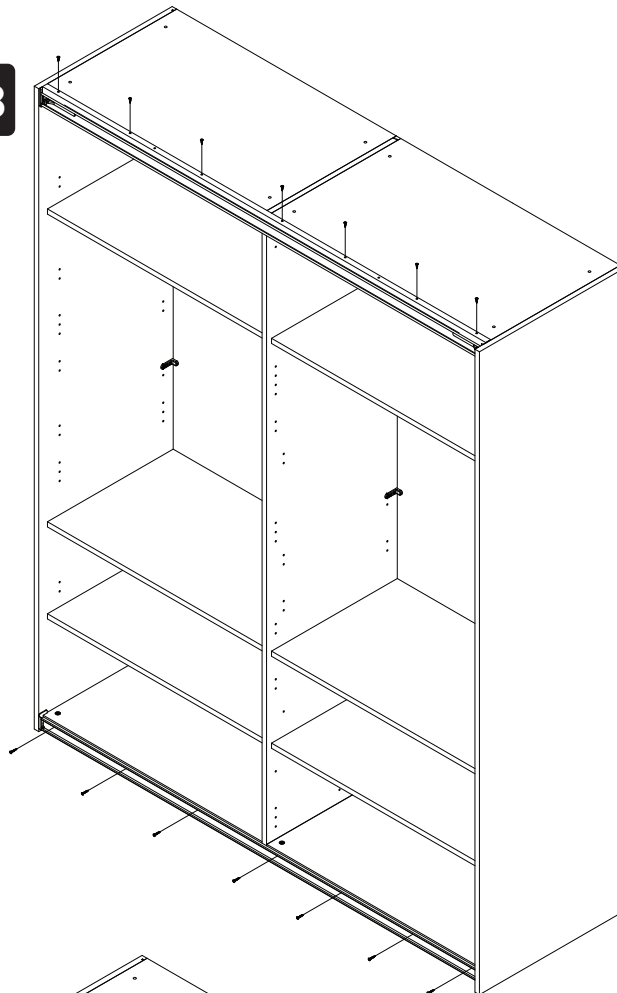

19

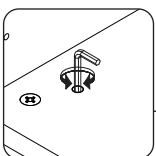
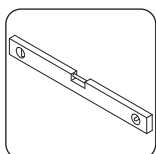
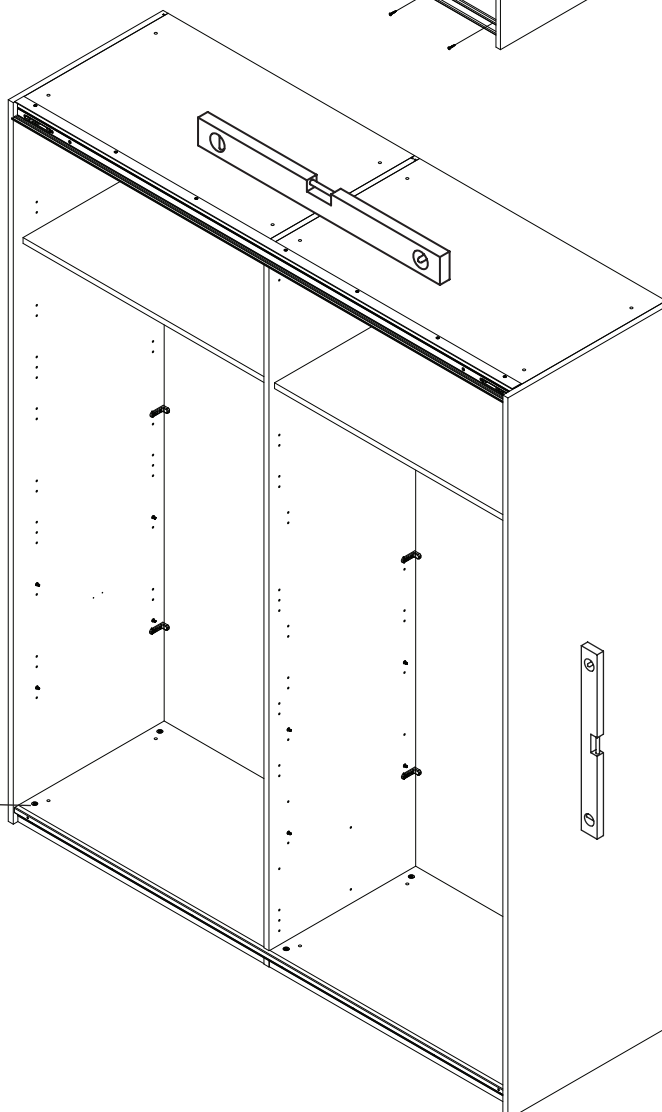

20

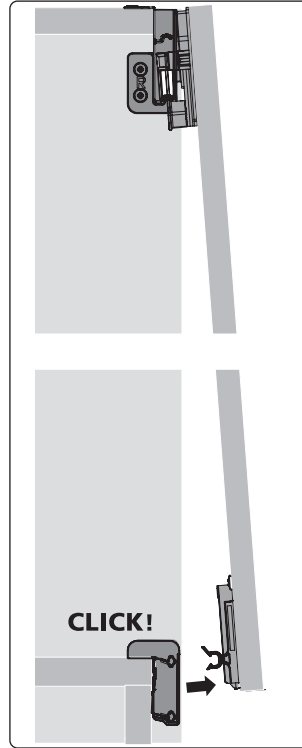
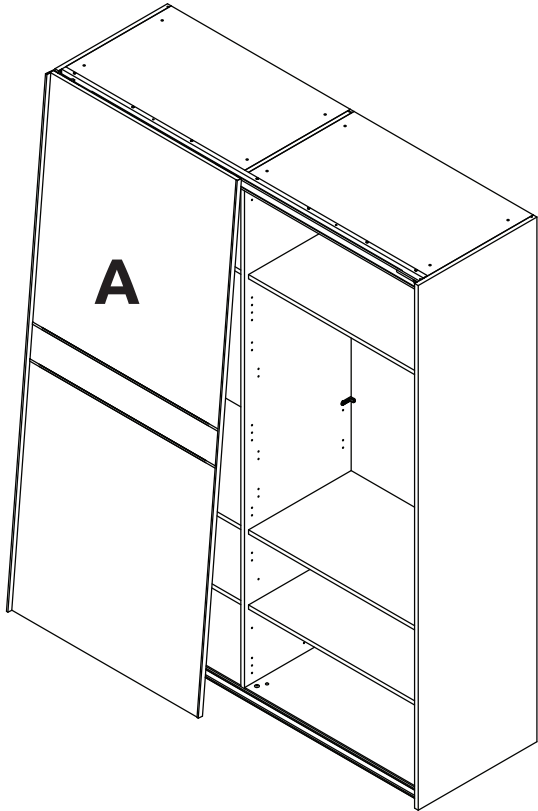
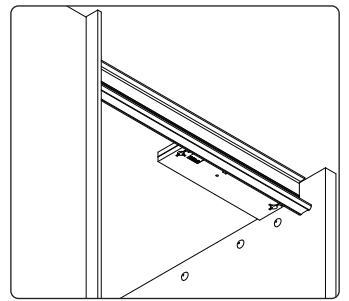
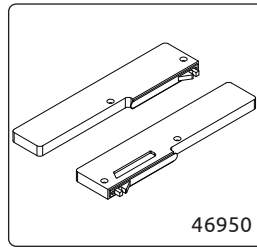
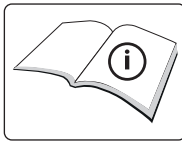

21

