

20.40.1707.00

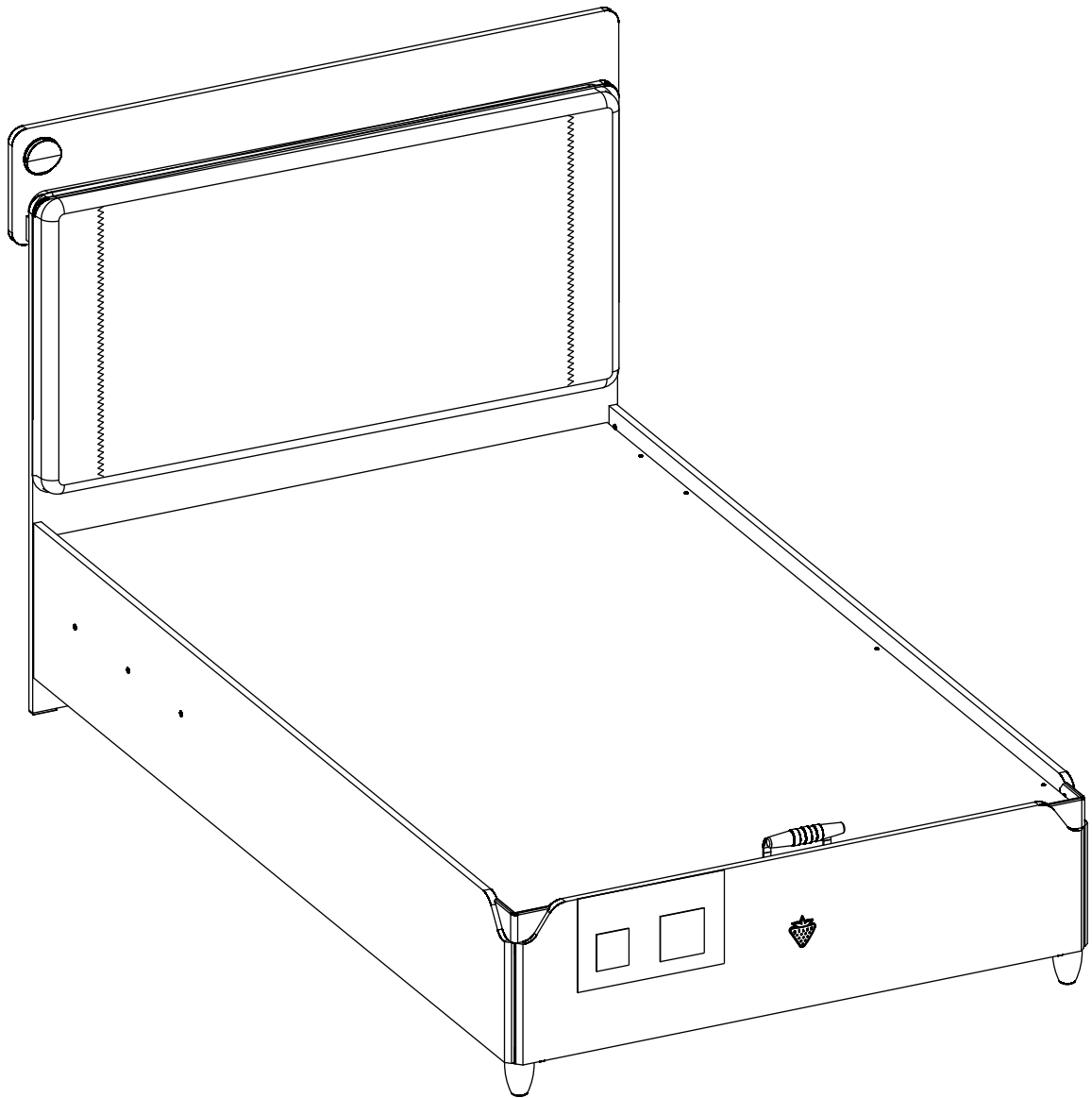

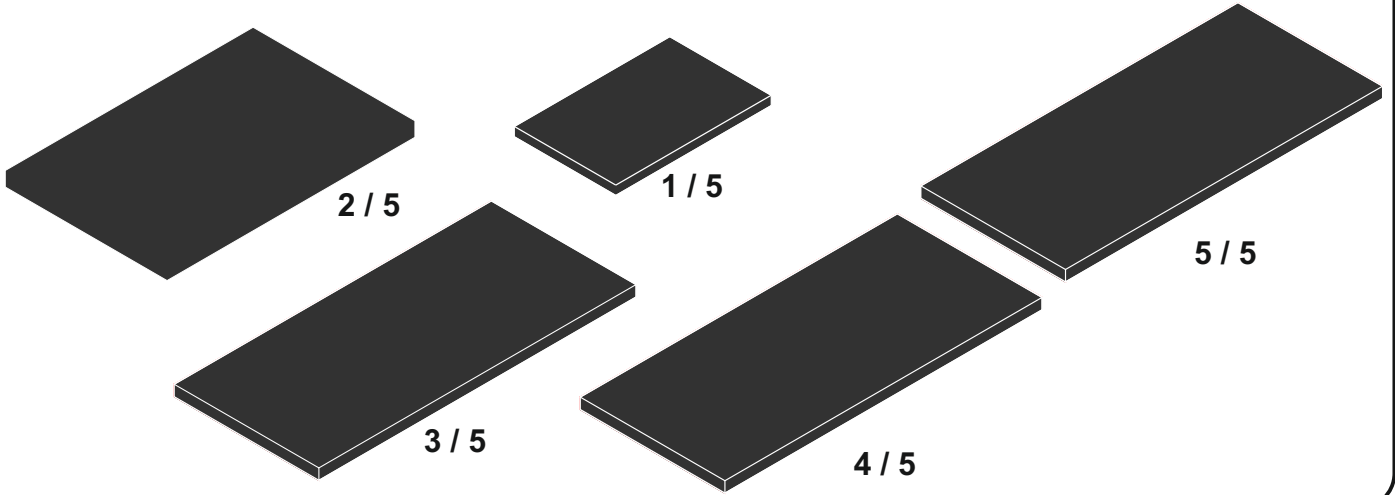

13.07.01.093 x 12

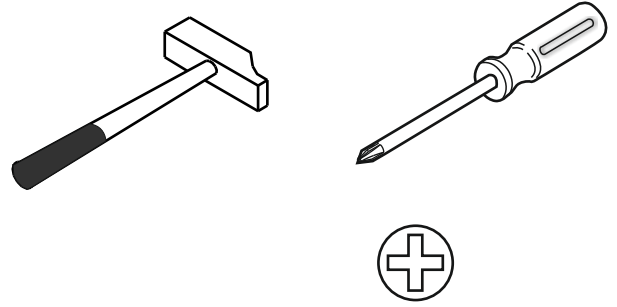
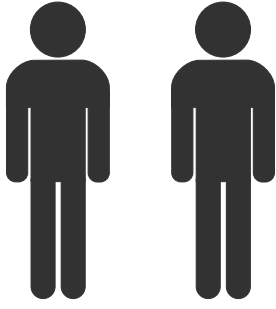

13.02.01.017 x 26



M6X13
13.03.01.021 x 12

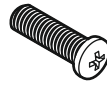

M6X20
13.03.01.026 x 6

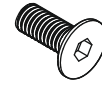

M6X15
13.03.01.024 x 6

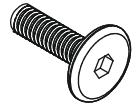

M6X15
13.03.01.023 x 2

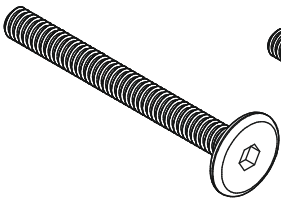

M6X55
13.03.01.039 x 4

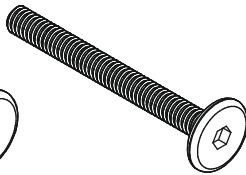

M6X45
13.03.01.037 x 4

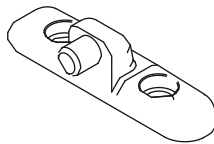

13.01.01.248 x 10

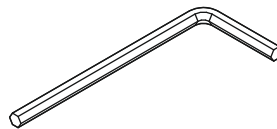

13.07.01.016 x 1

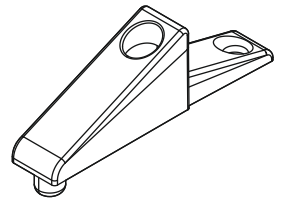

13.01.01.247 x 6

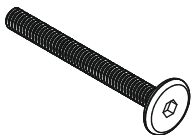

M6X35
13.03.01.033 x 2

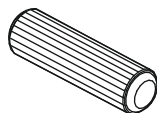

13.01.01.111 x 4



M4X13
13.03.01.007 x 2

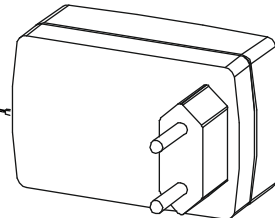

13.15.01.093 x 1

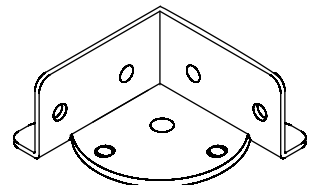

13.07.02.172 x 2

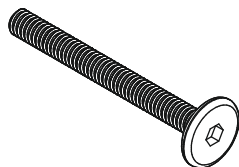

M6X50
13.50.01.057 x 3

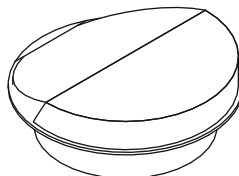

13.15.01.118 x 1

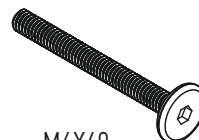

M6X40
13.03.01.035 x 4

1 / 5

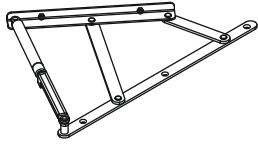

13.07.01.576 x 1

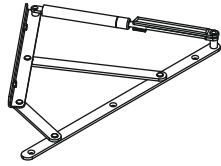

13.07.01.577 x 1

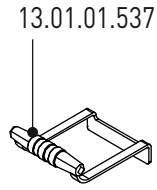

13.01.01.537
18.40.1707.203 x 1



13.01.02.121 x 2

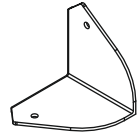

13.01.02.117 x 2

2 / 5

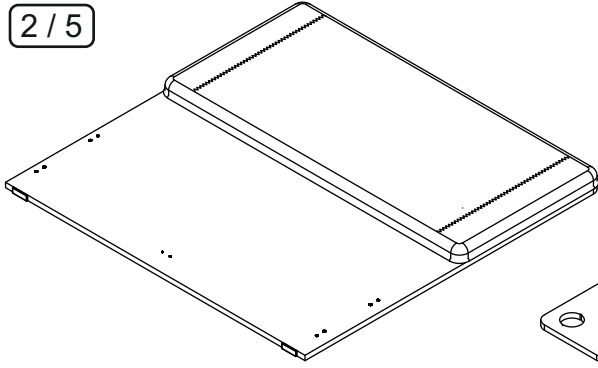

18.40.1707.006 x 1

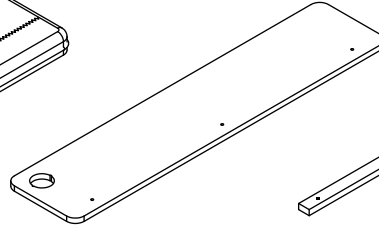

18.40.1707.007 x 1

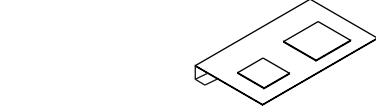

13.10.01.174 x 1

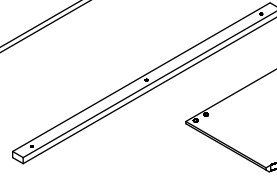

18.40.1707.008 x 1

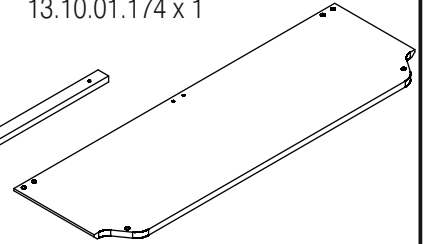

18.40.1707.003 x 1

3 / 5

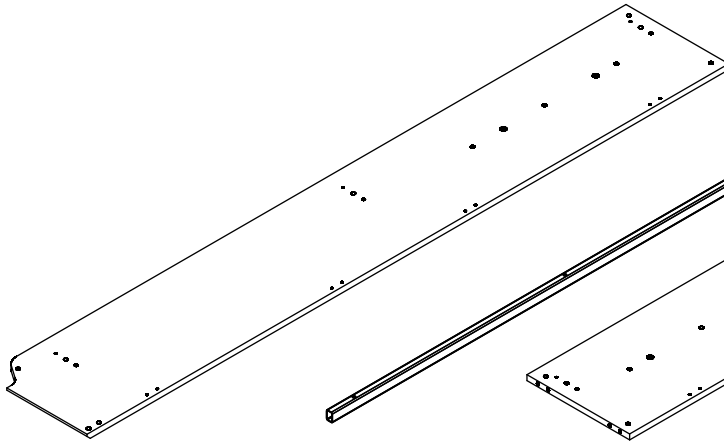

18.40.1707.001 x 1

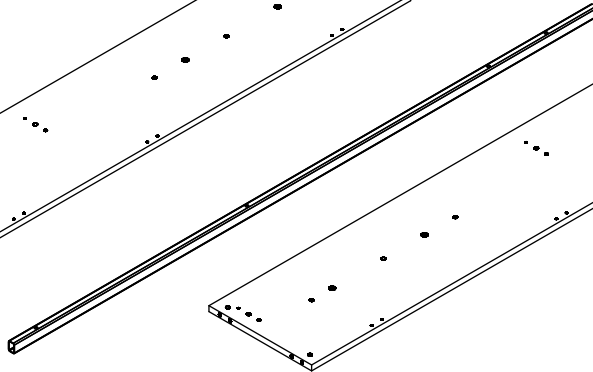

18.40.1707.201 x 2

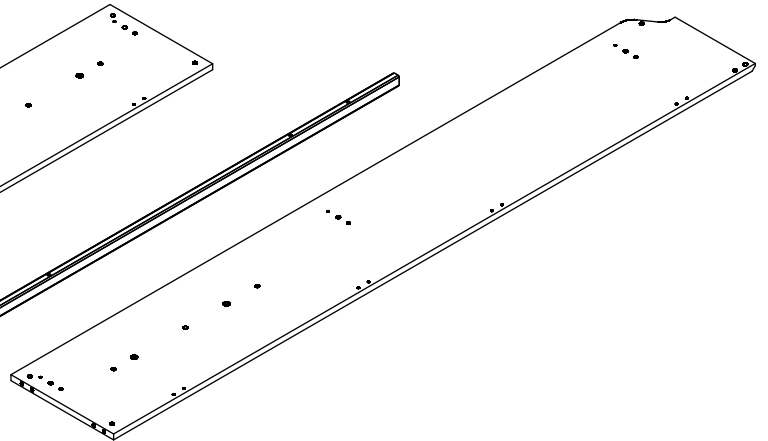

18.40.1707.002 x 1

4 / 5

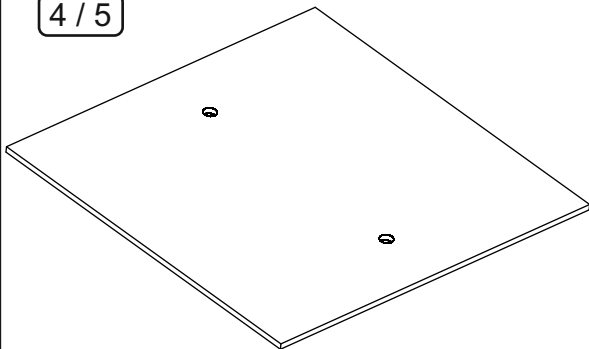

18.40.1707.004 x 2

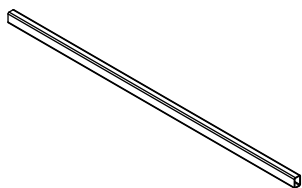

18.40.1707.202

5 / 5

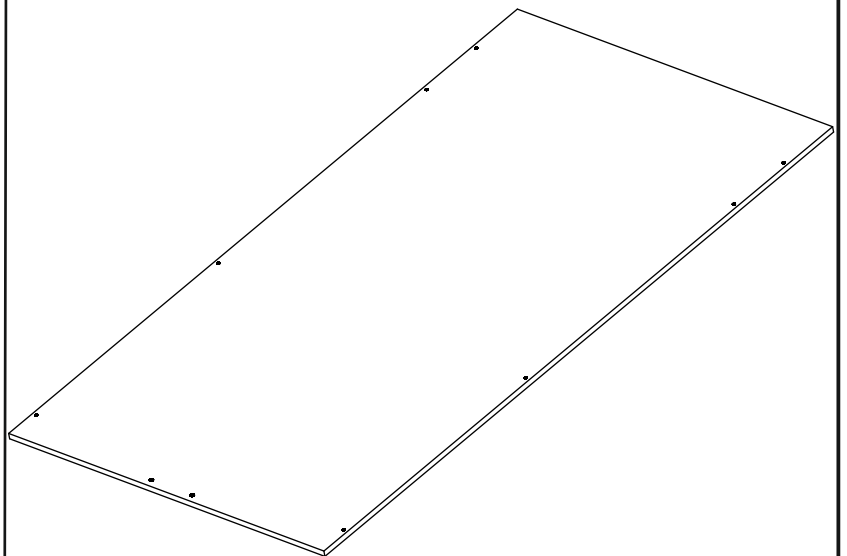

18.40.1707.005

1

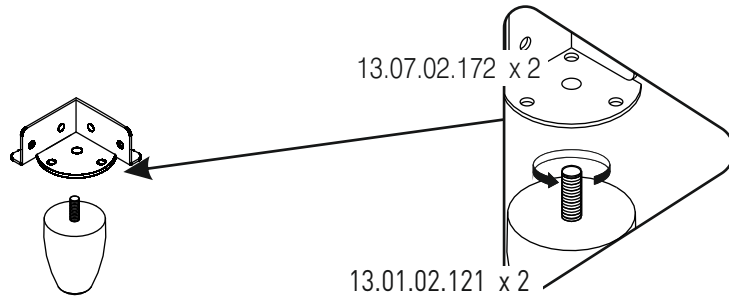

2

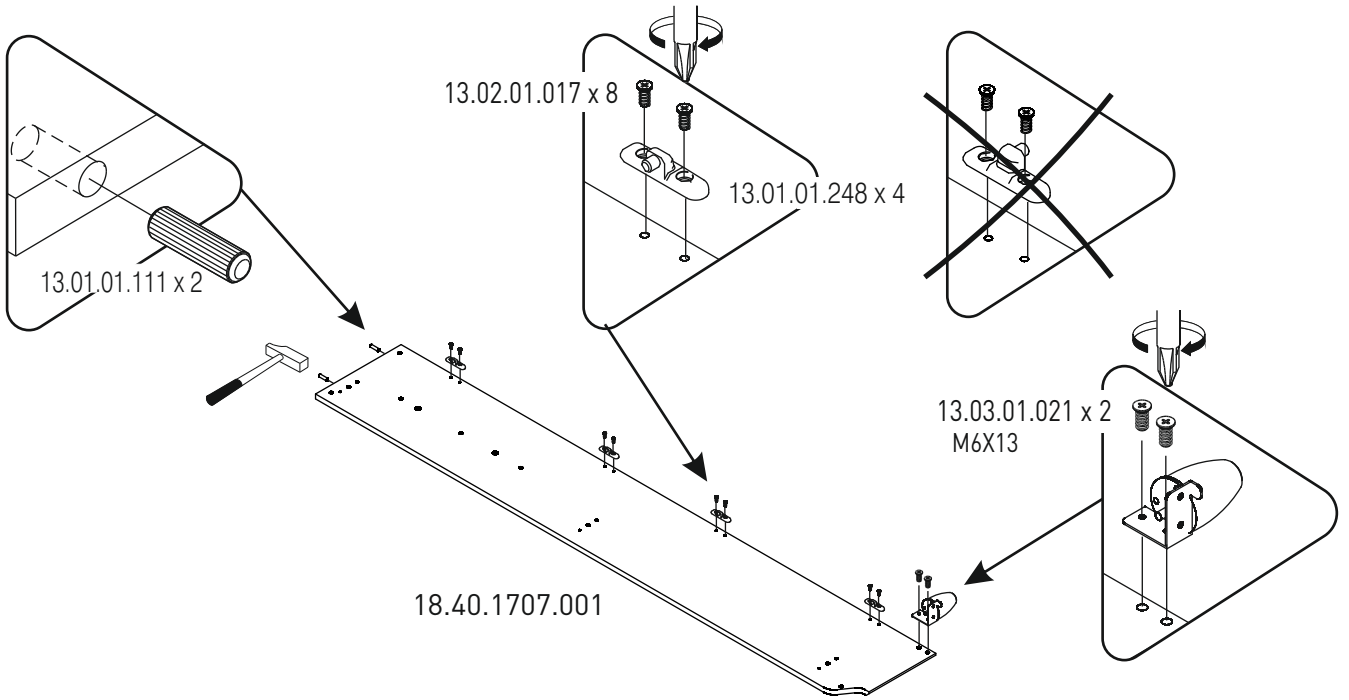

3

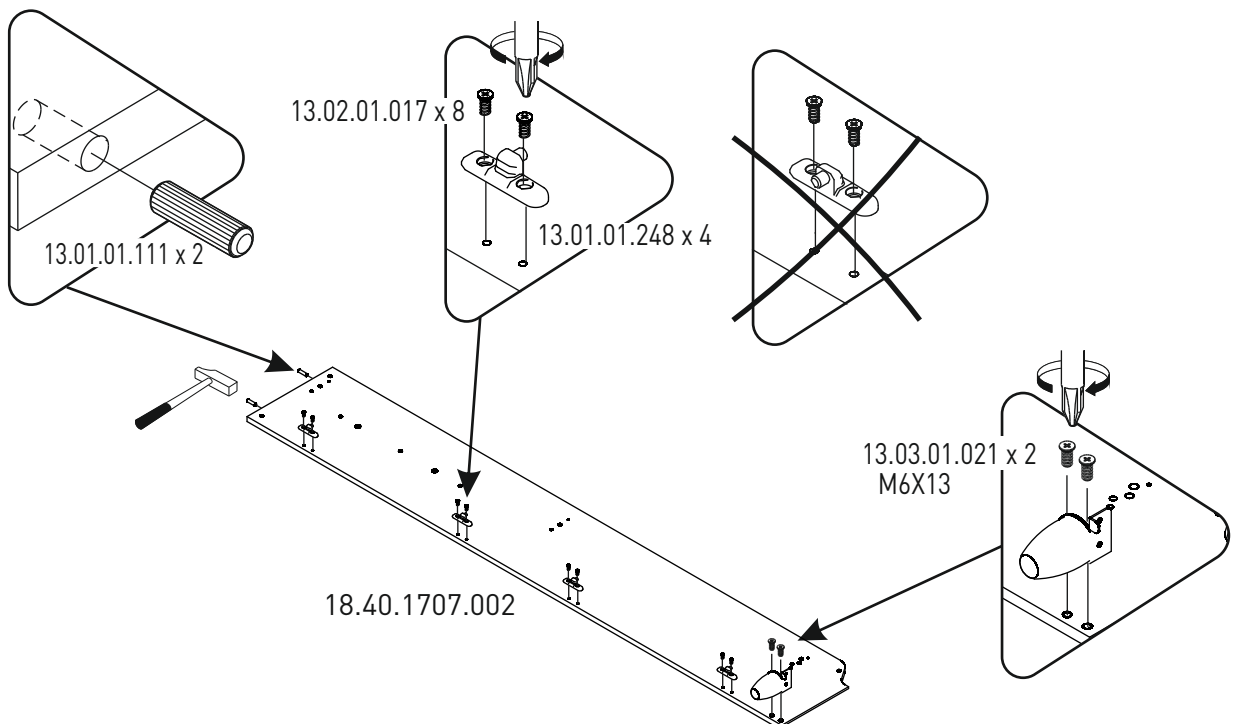

4

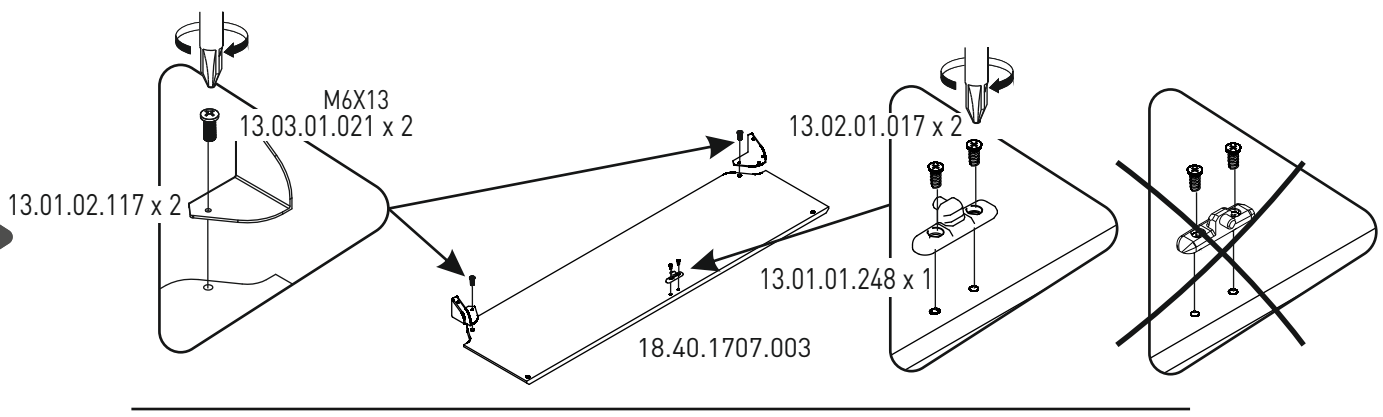

5

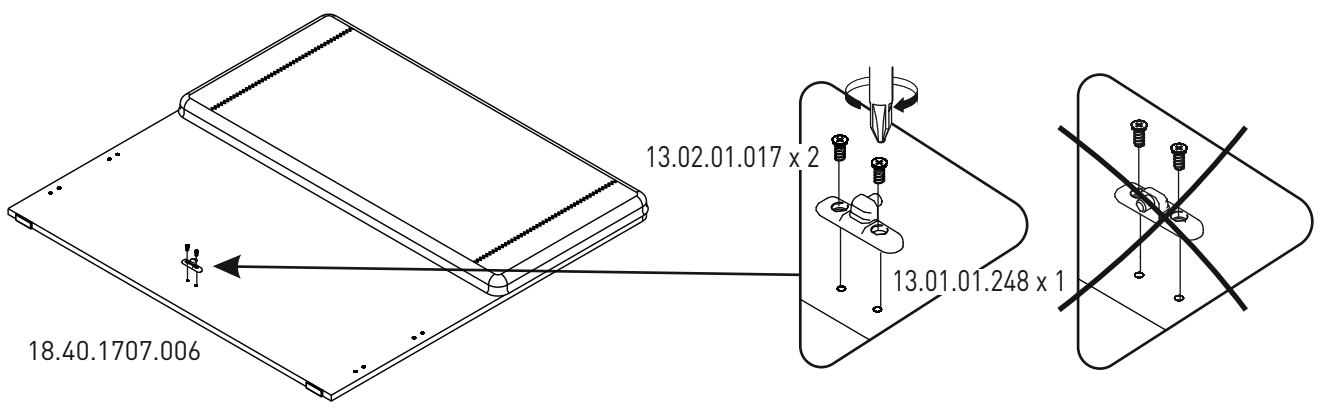

6

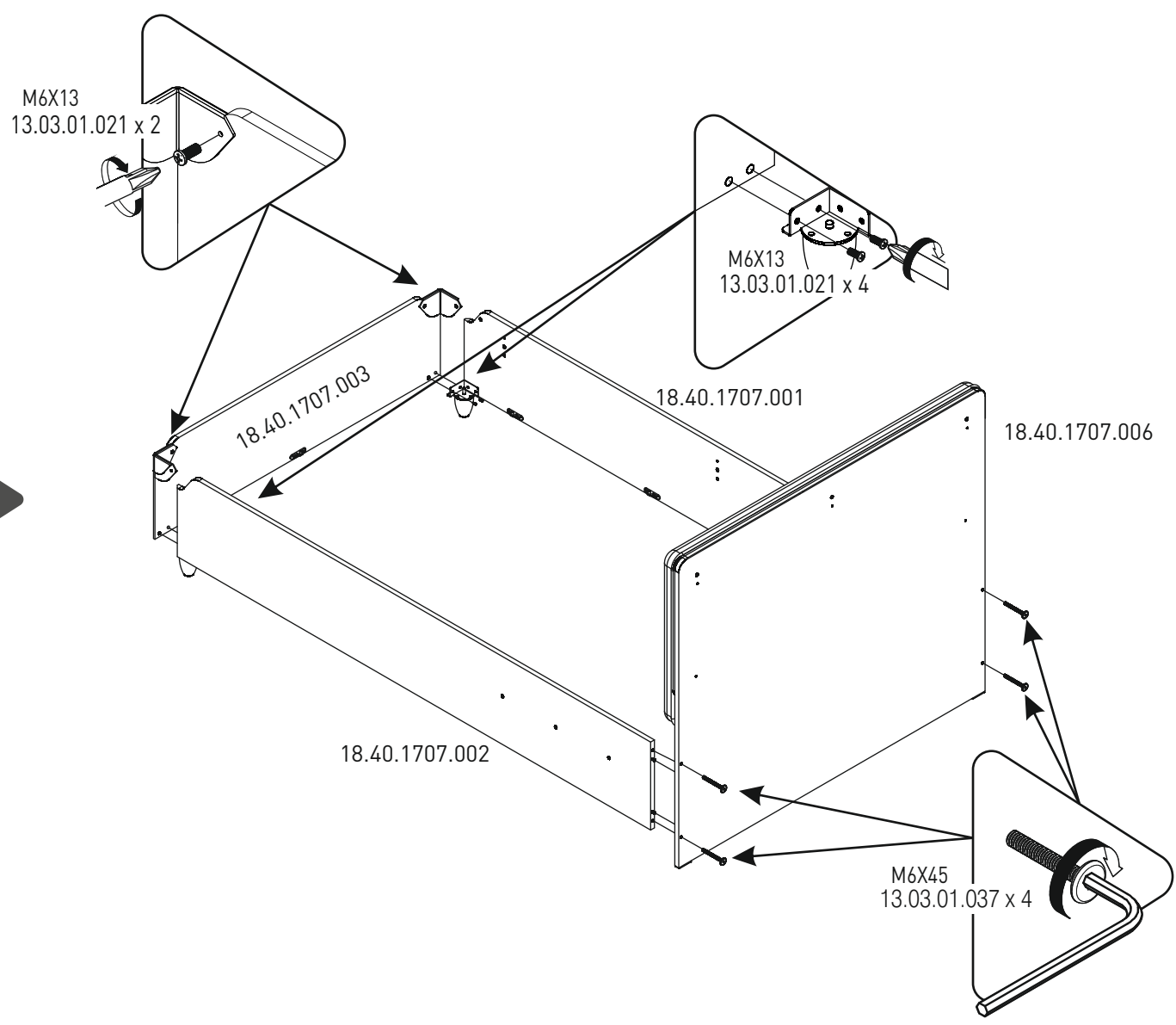

7

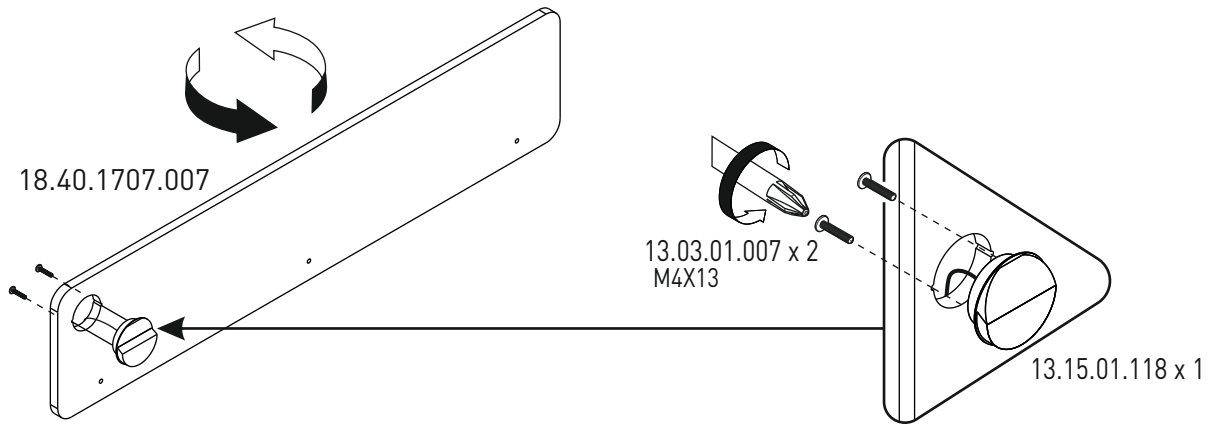

8

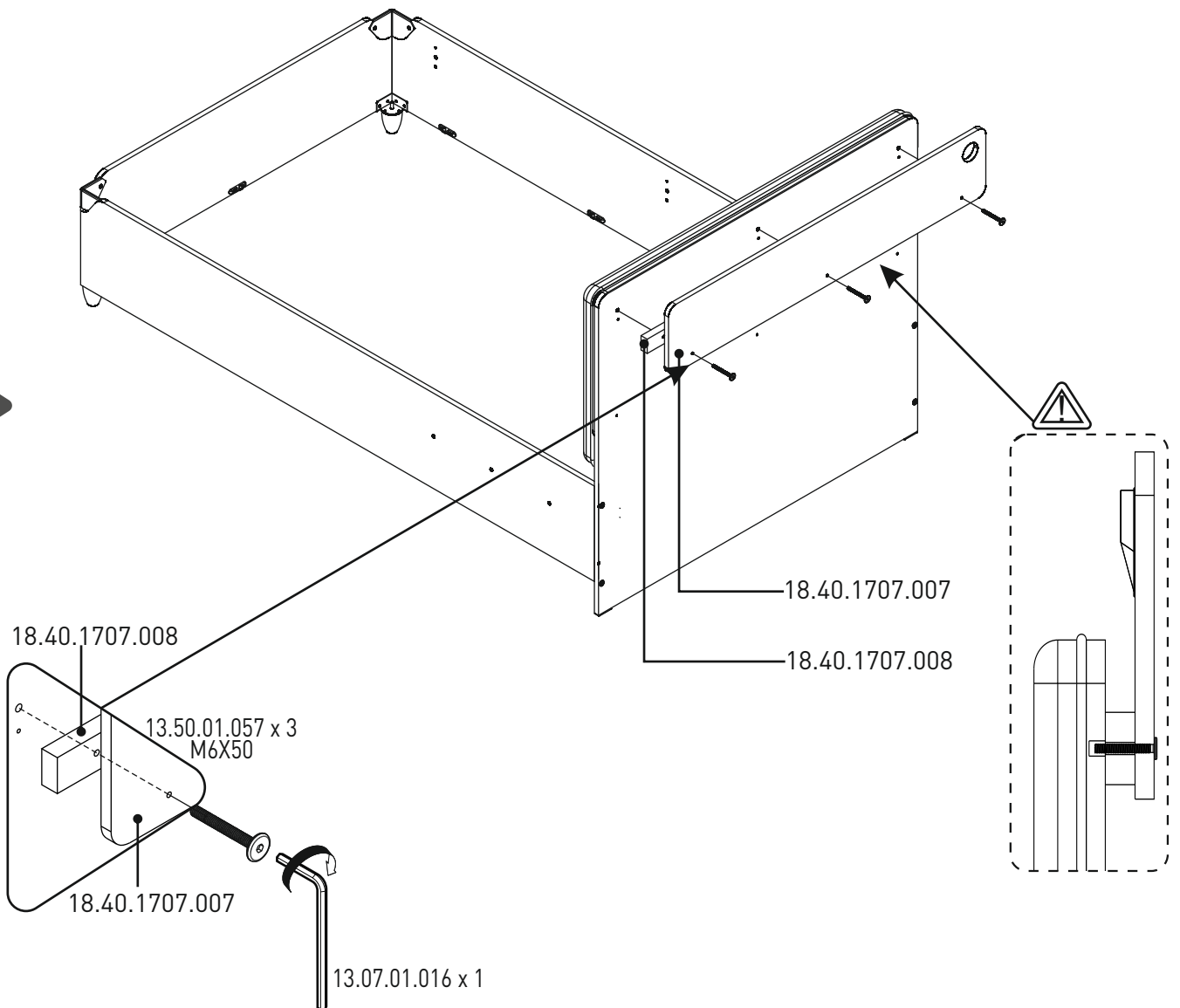

9

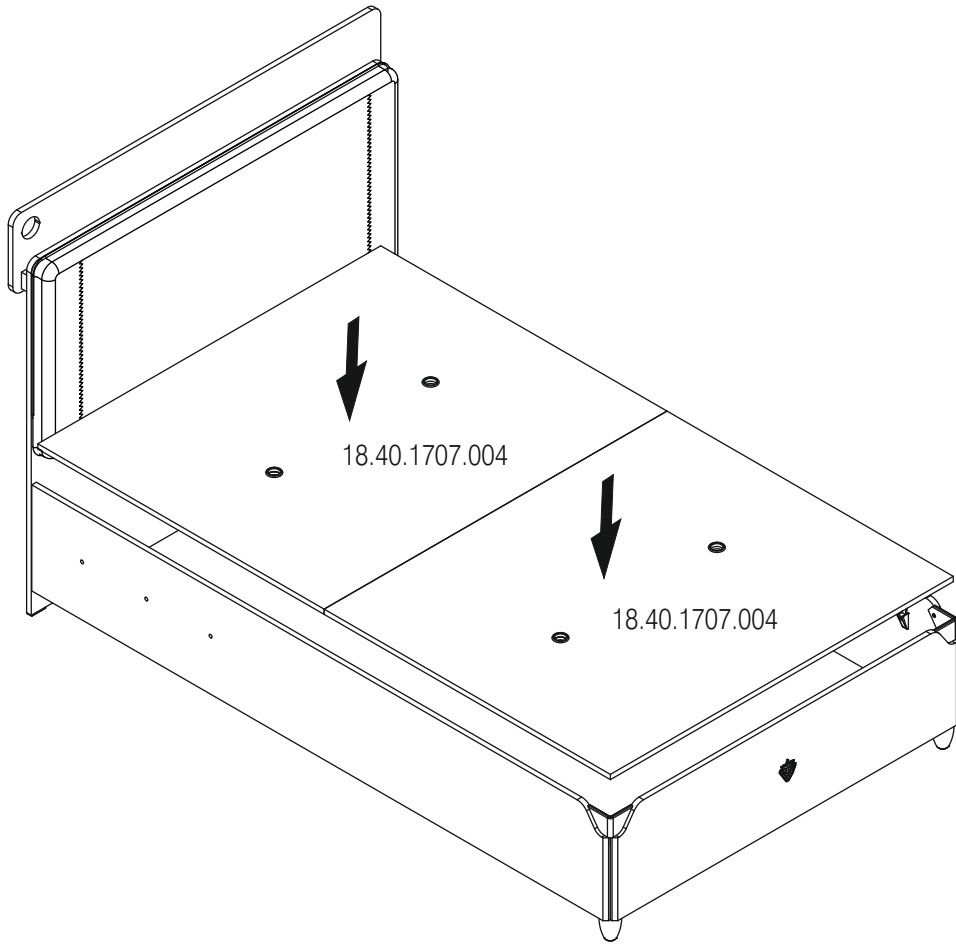

10

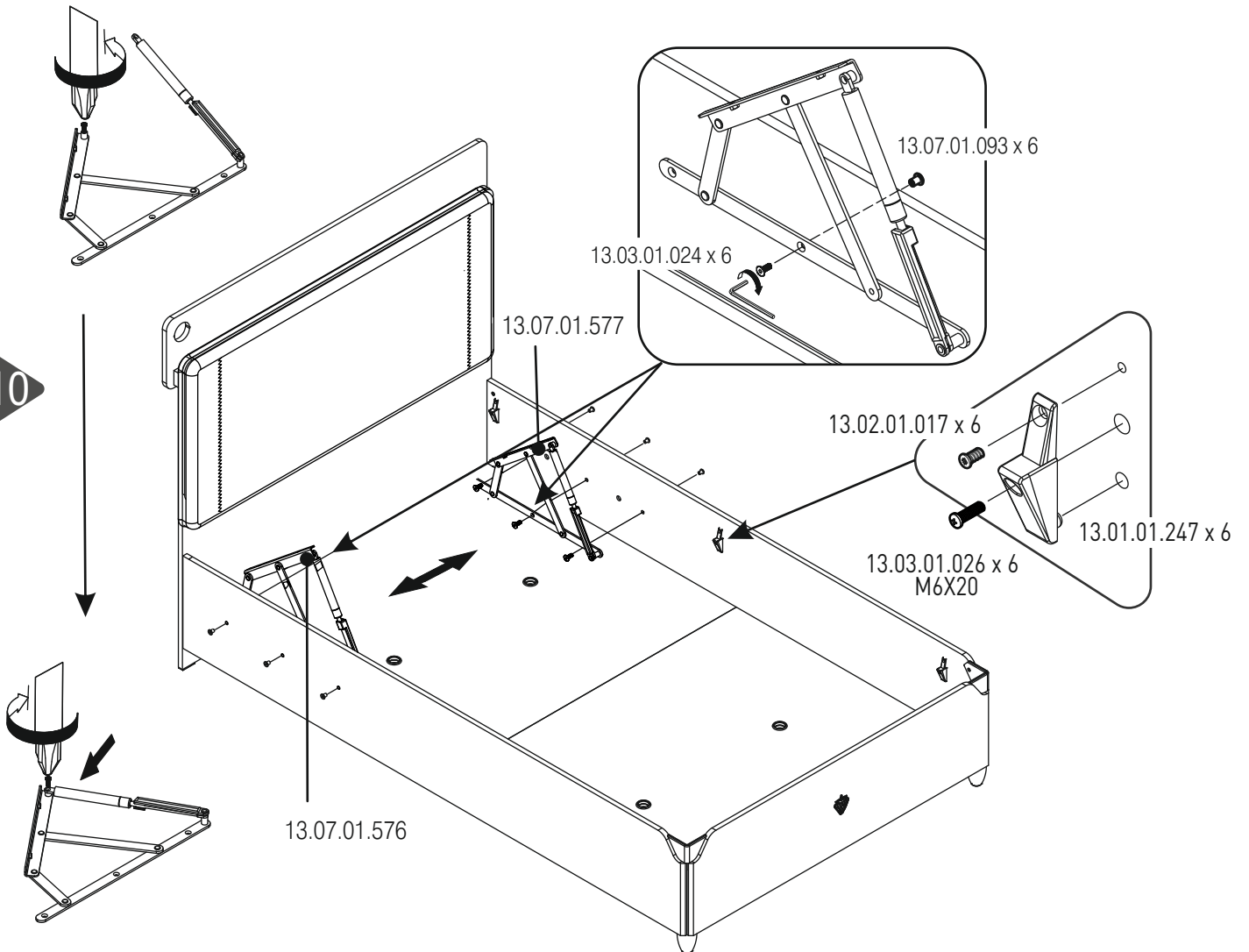

11

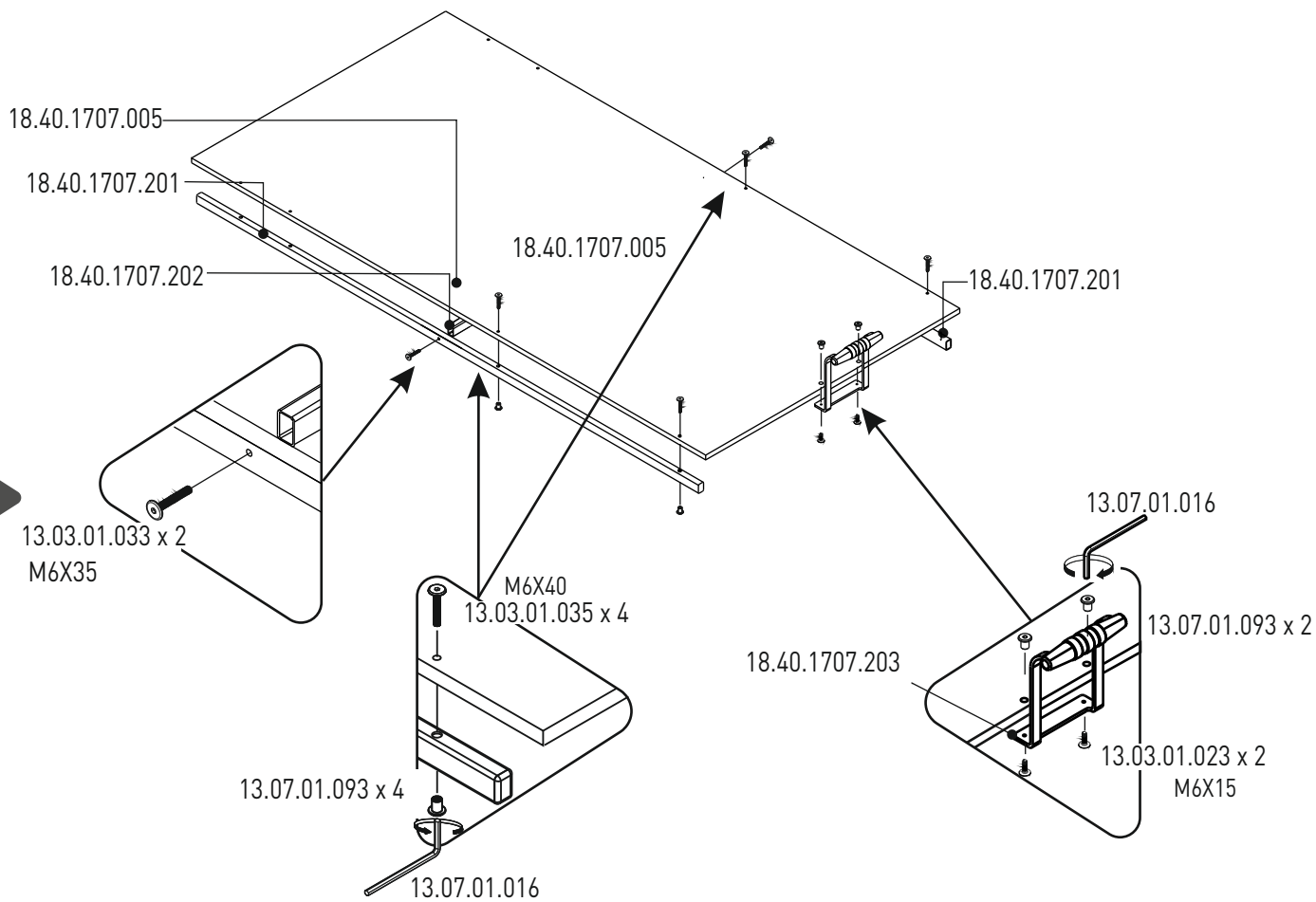

12

