

20.50.1902.00

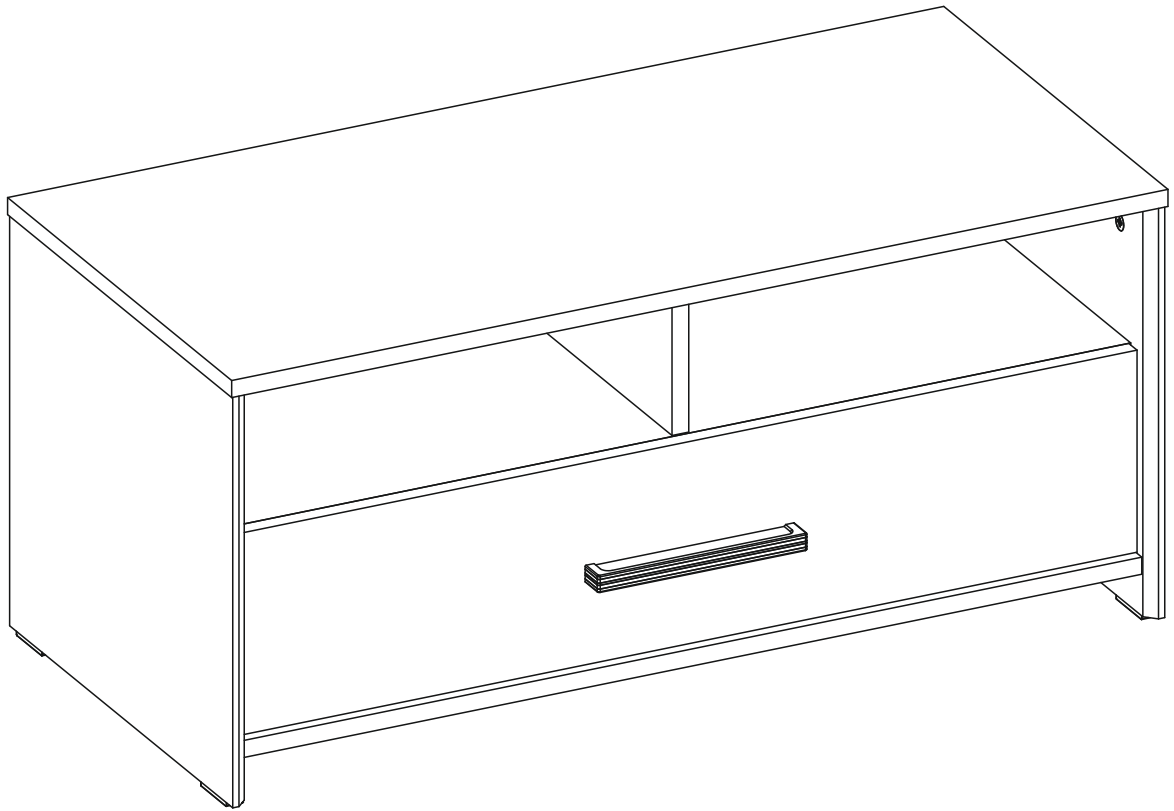

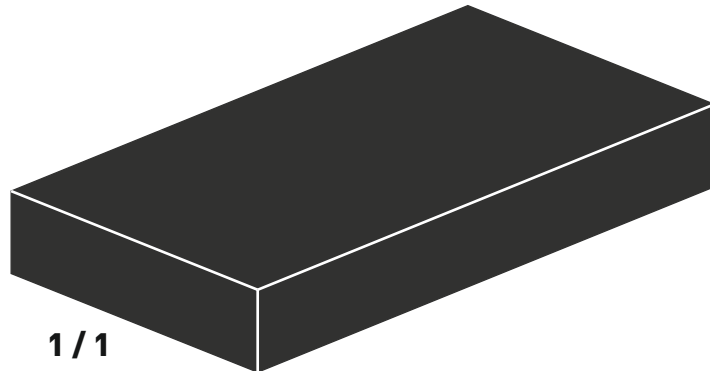

1 / 1

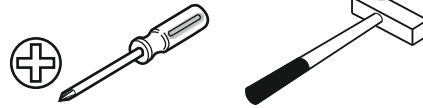
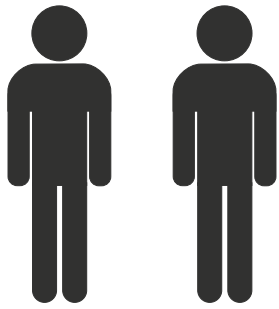
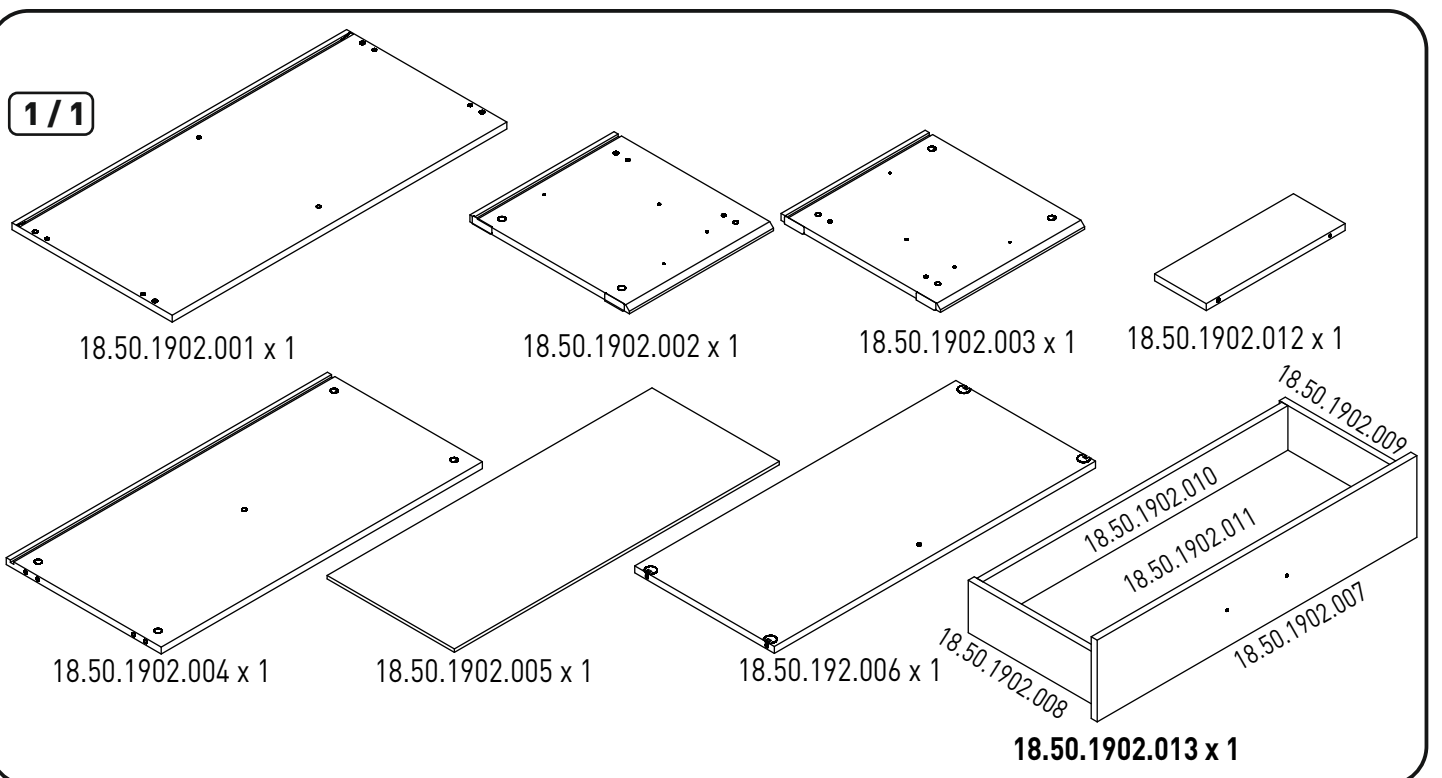
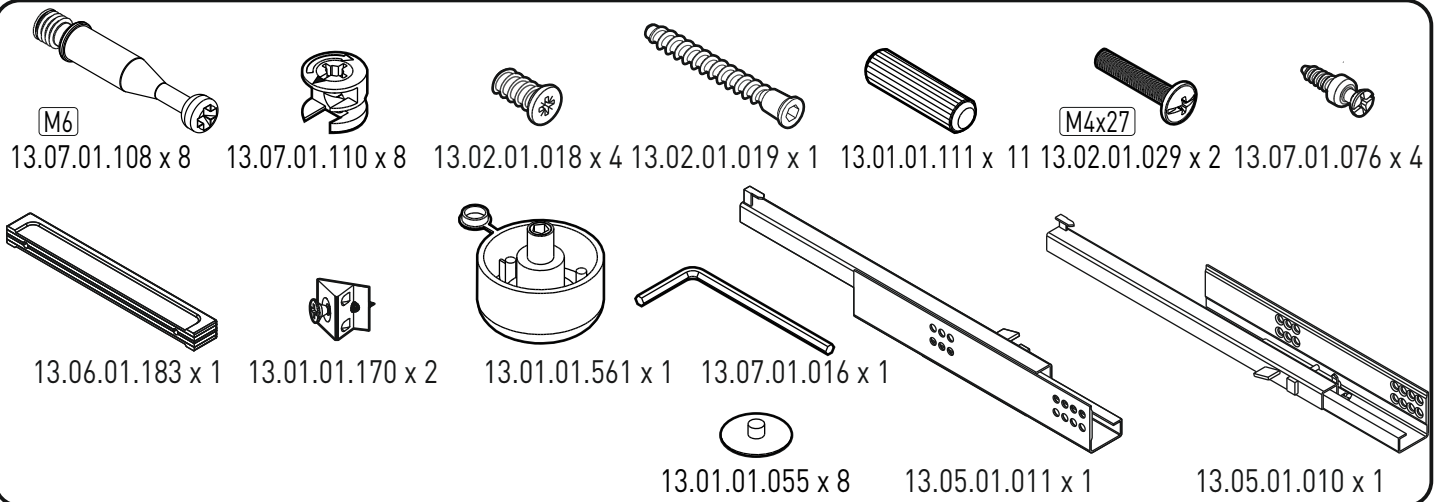

1

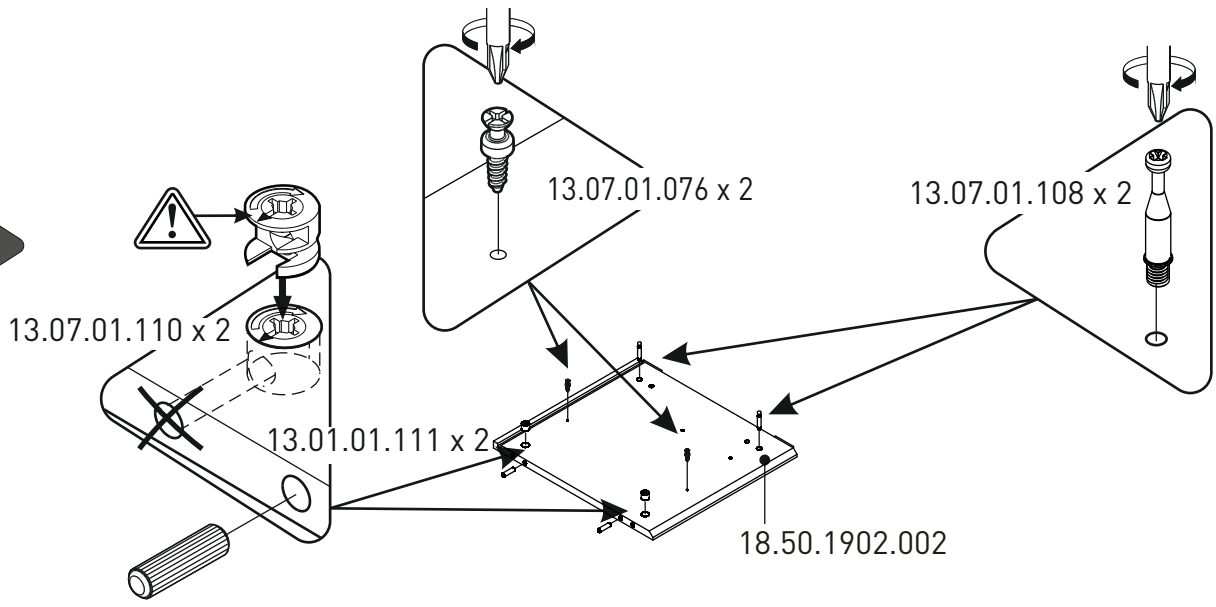

2

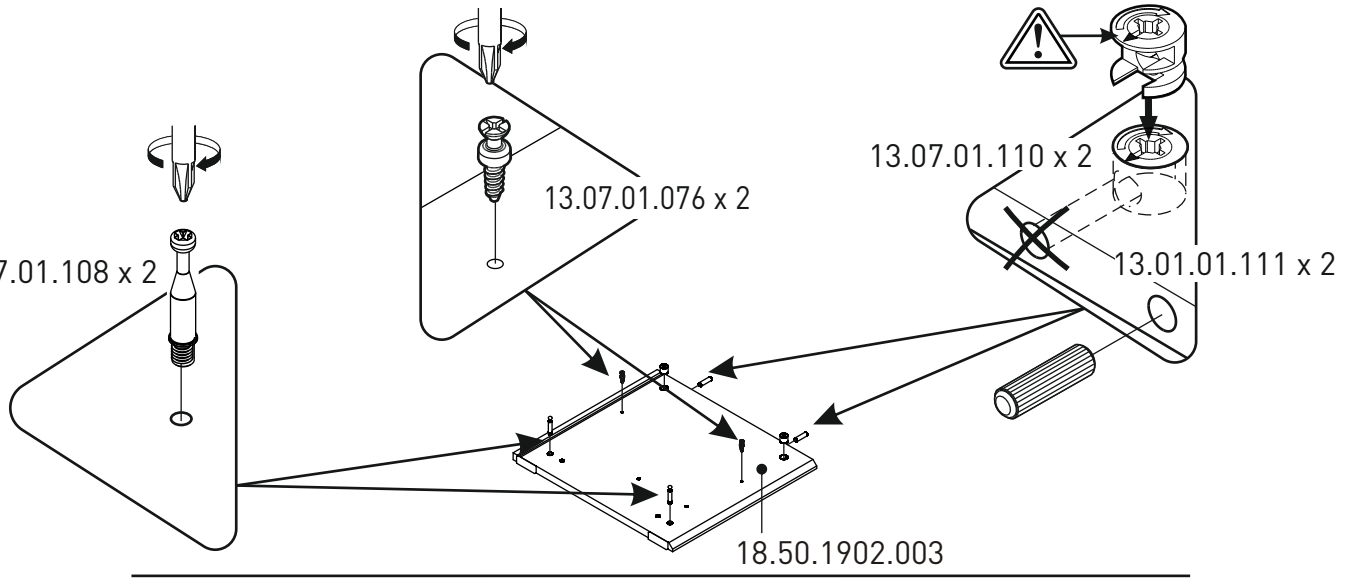

3

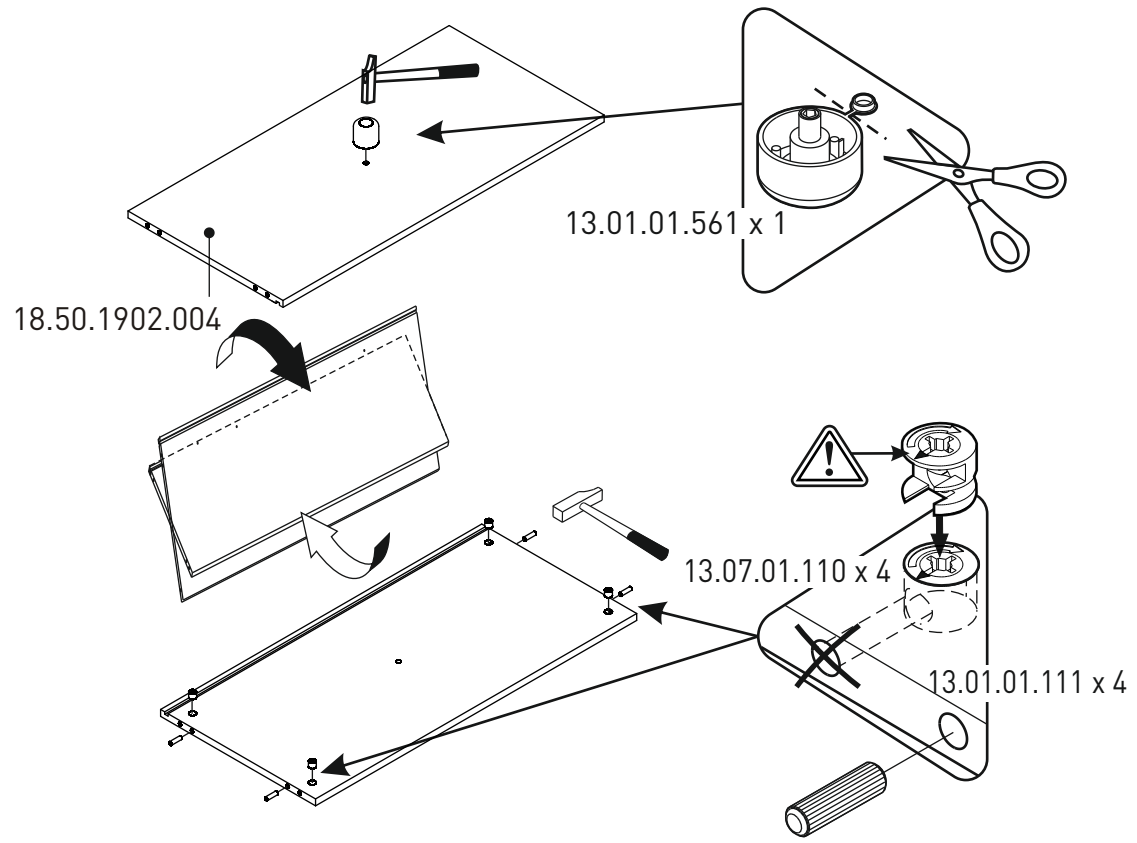

4

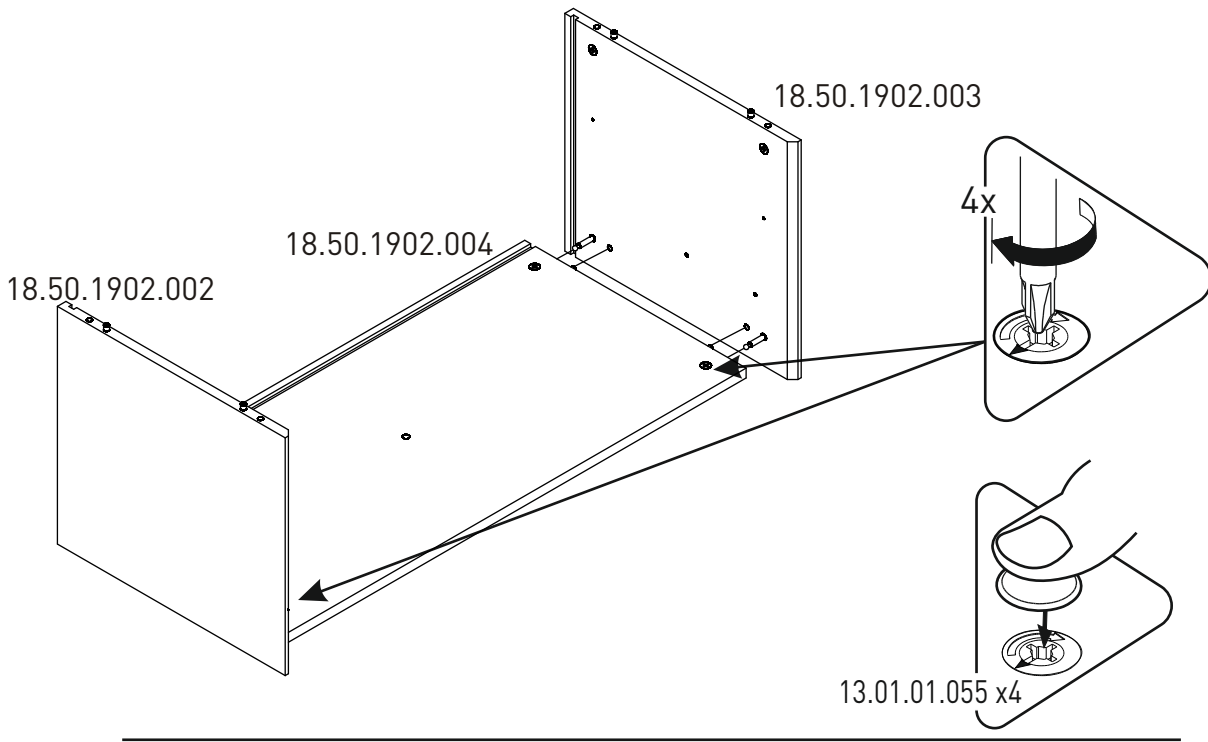

5

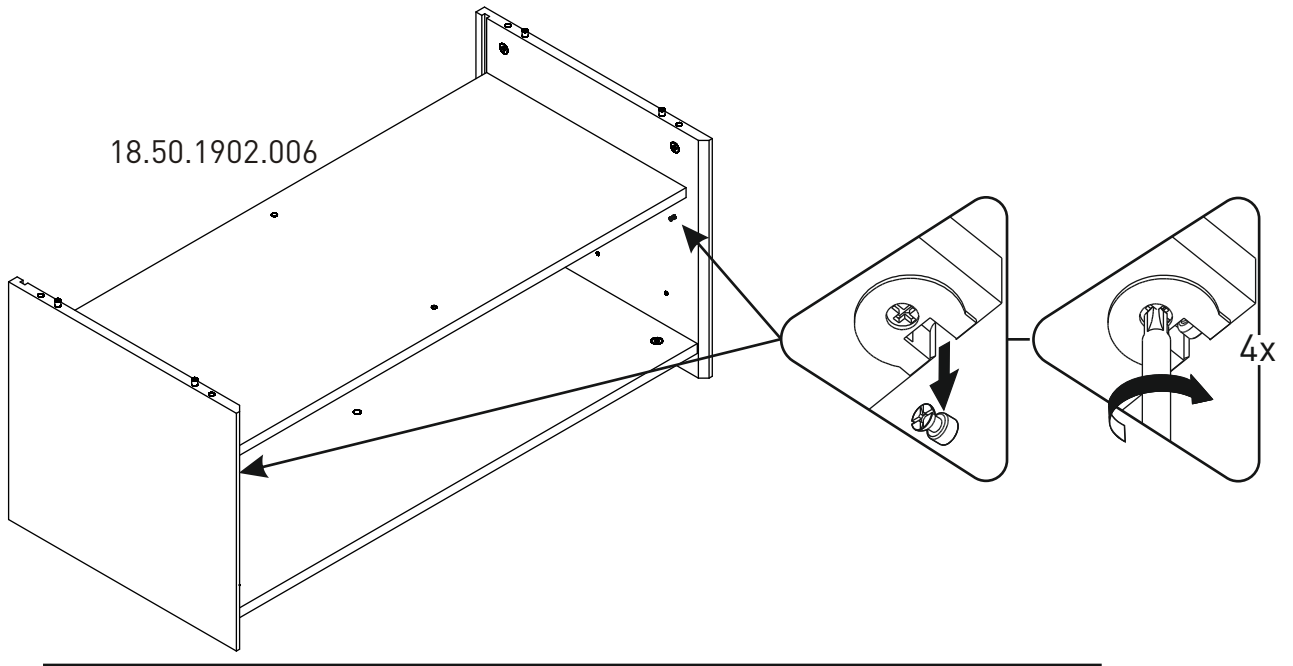

6

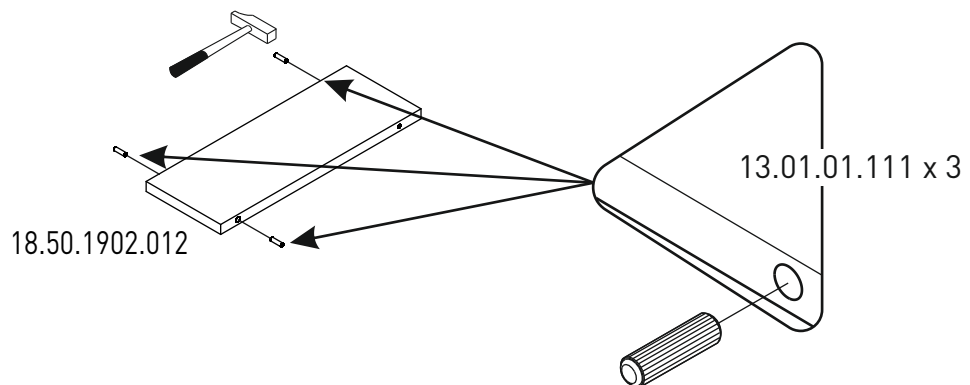

7

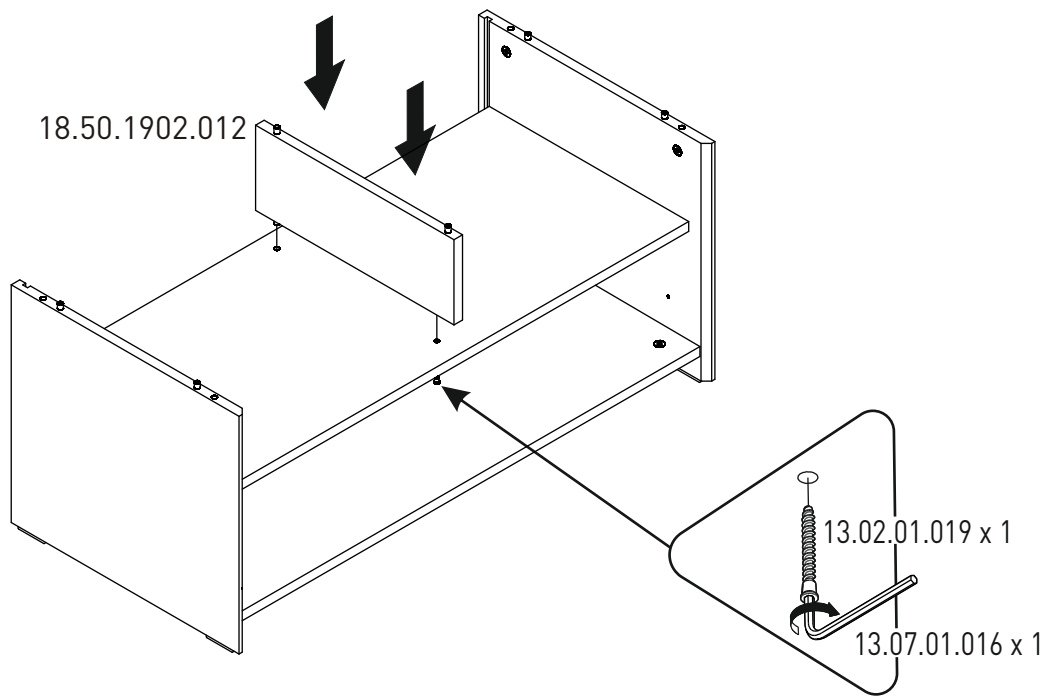

8

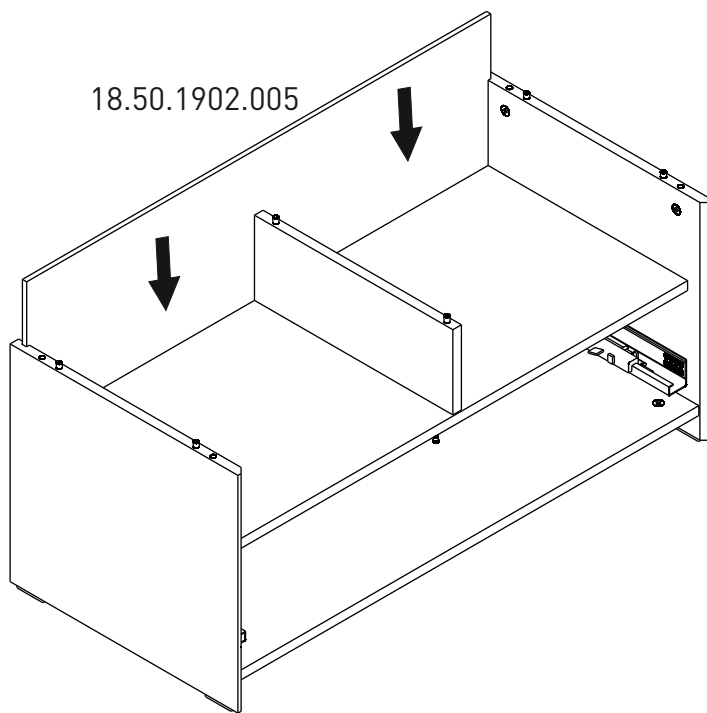

9

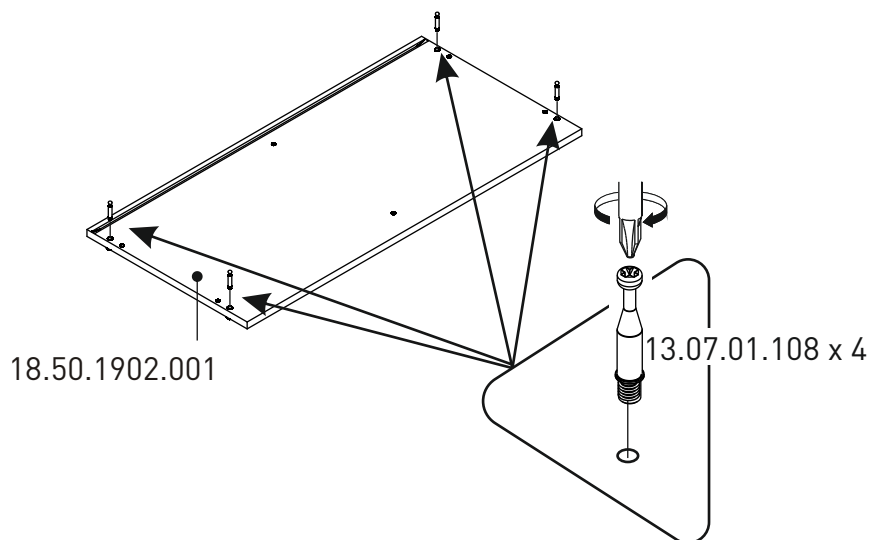

10

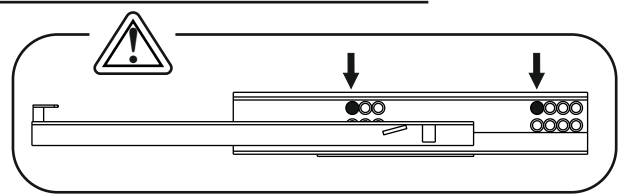
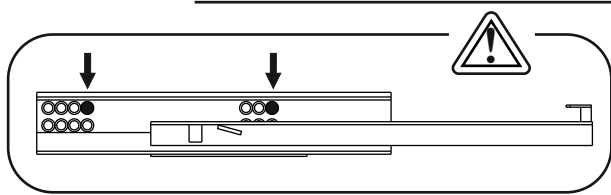
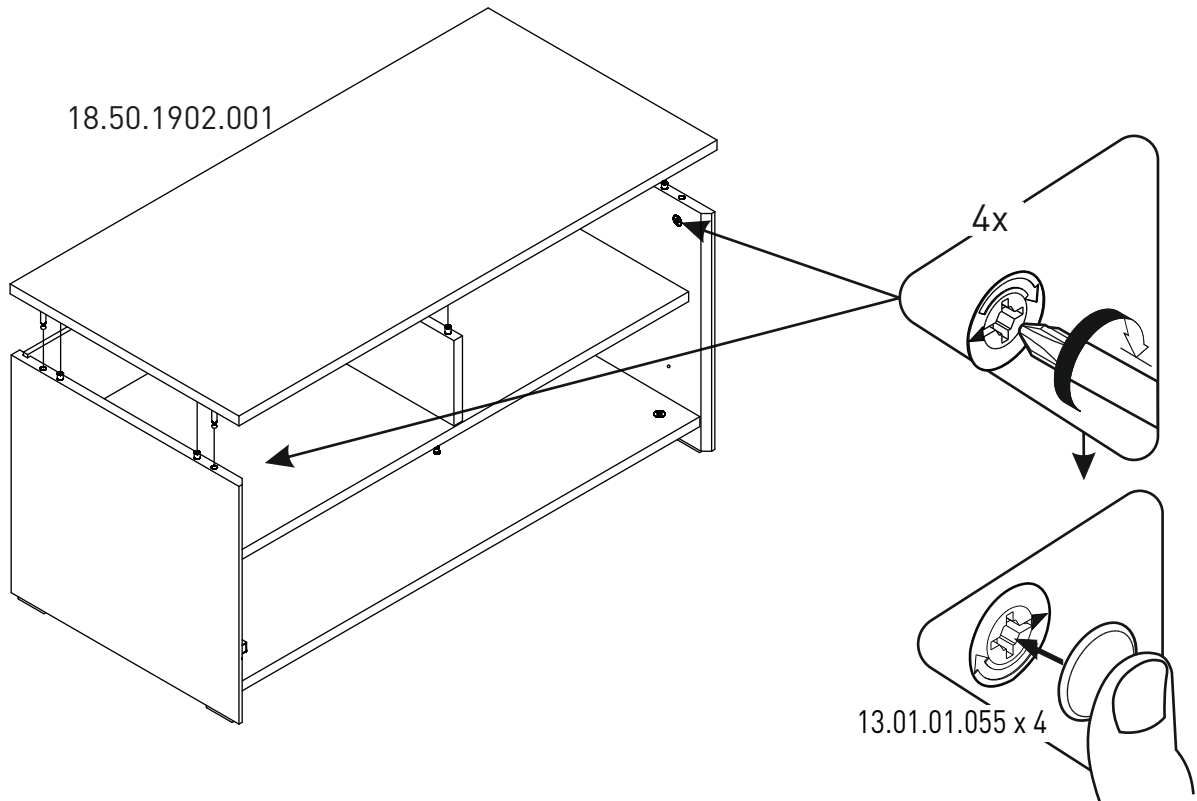

11

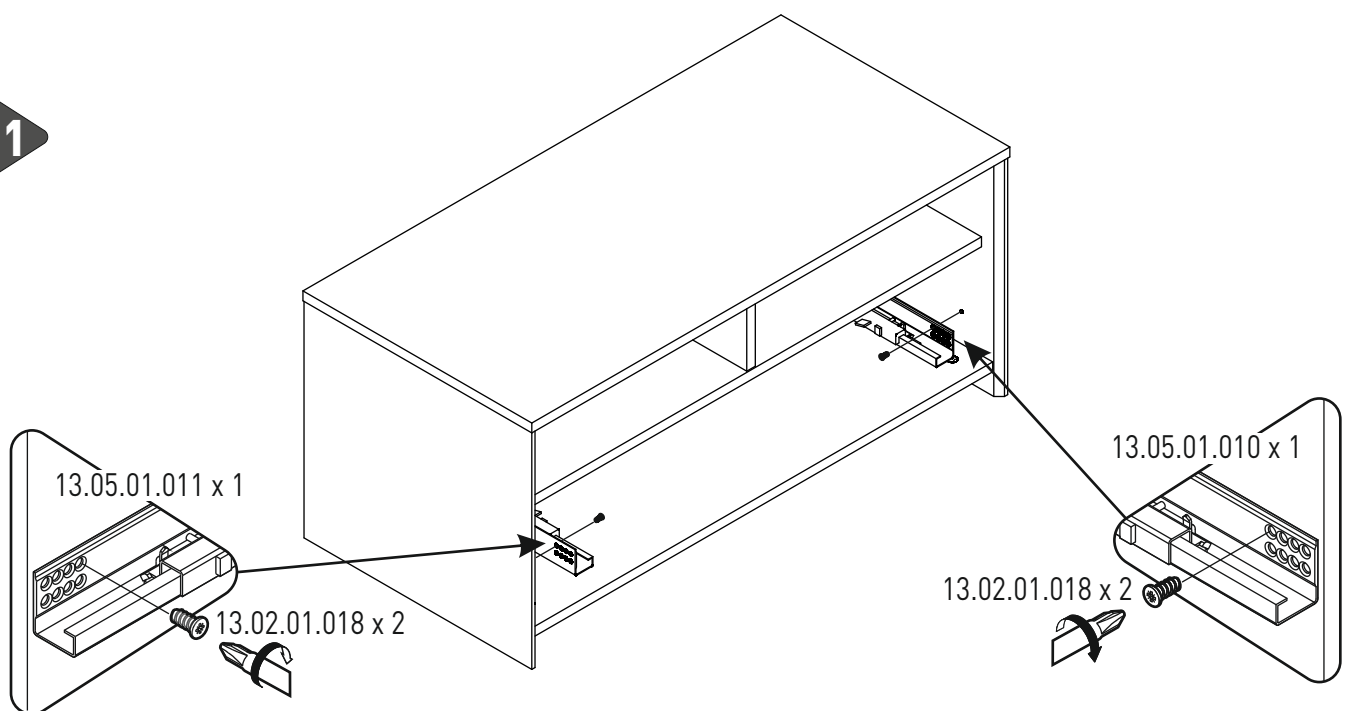

12

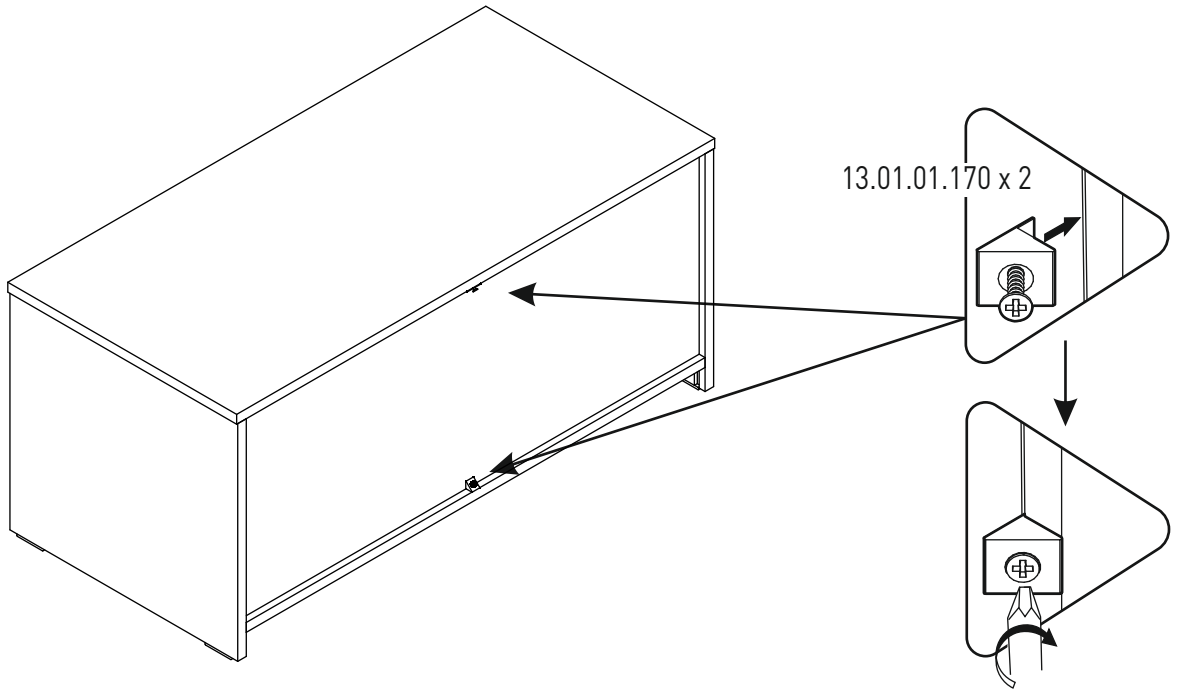

13

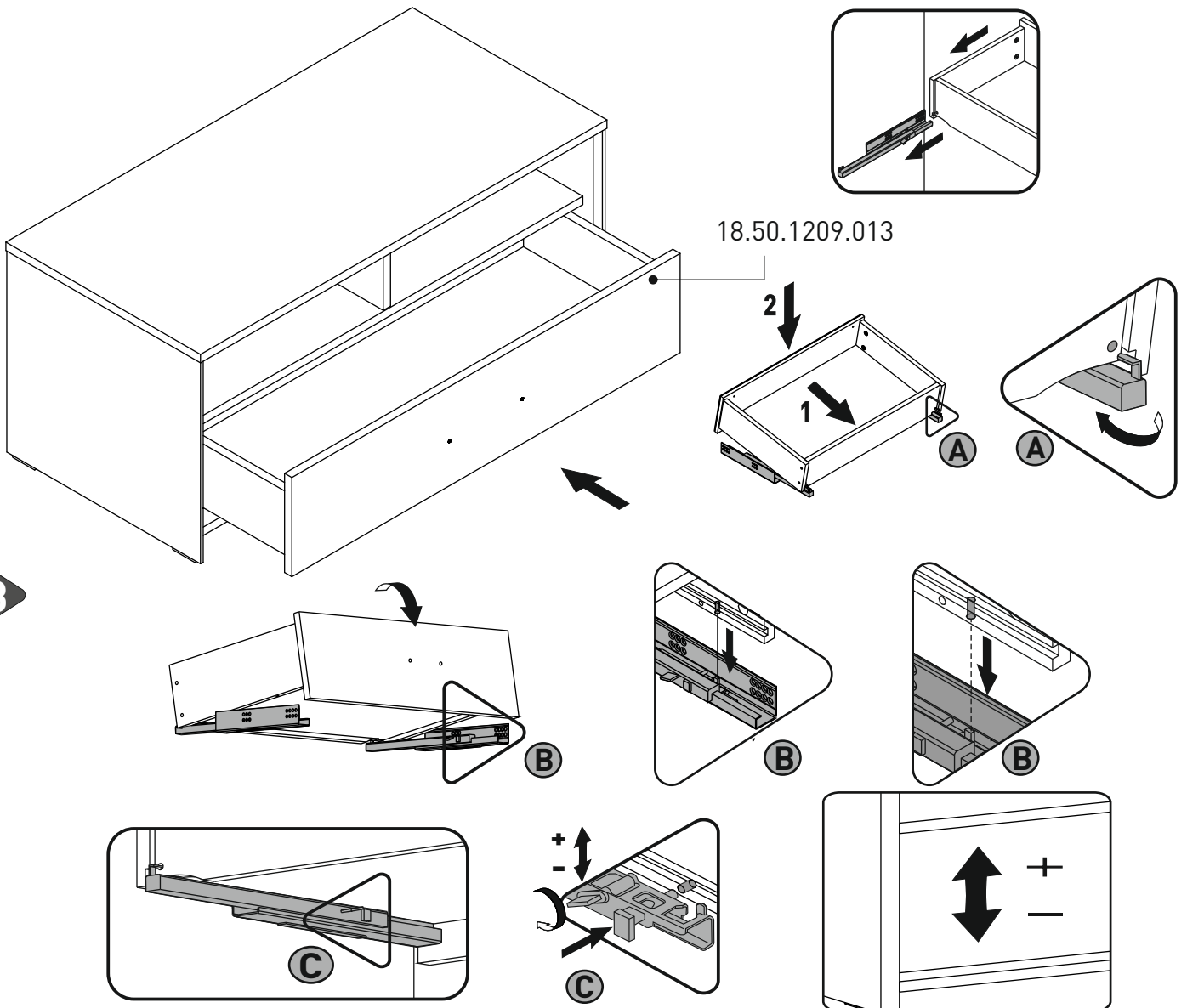

14

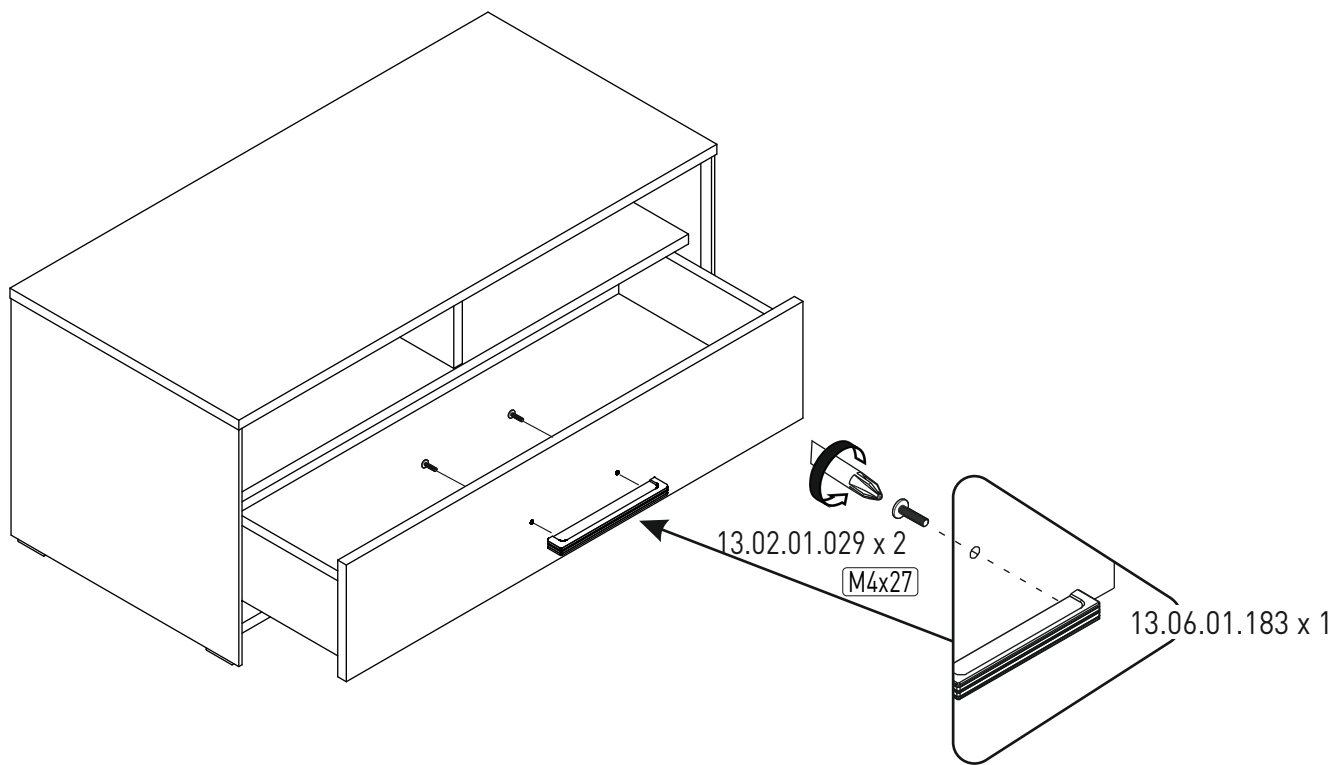

15

