

Model: **RANDOM TV 180** **1/11**

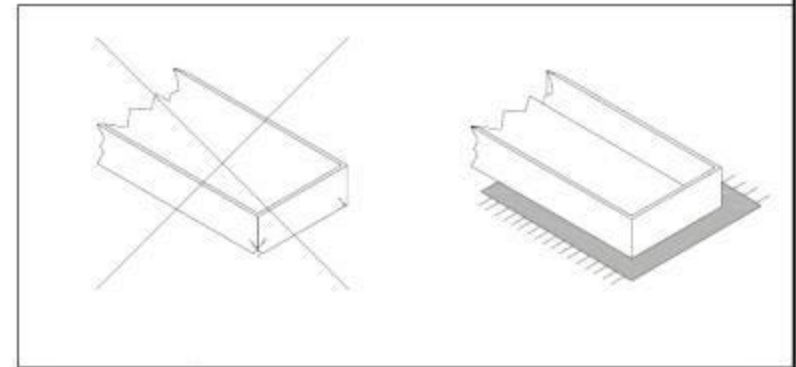

BAG 1

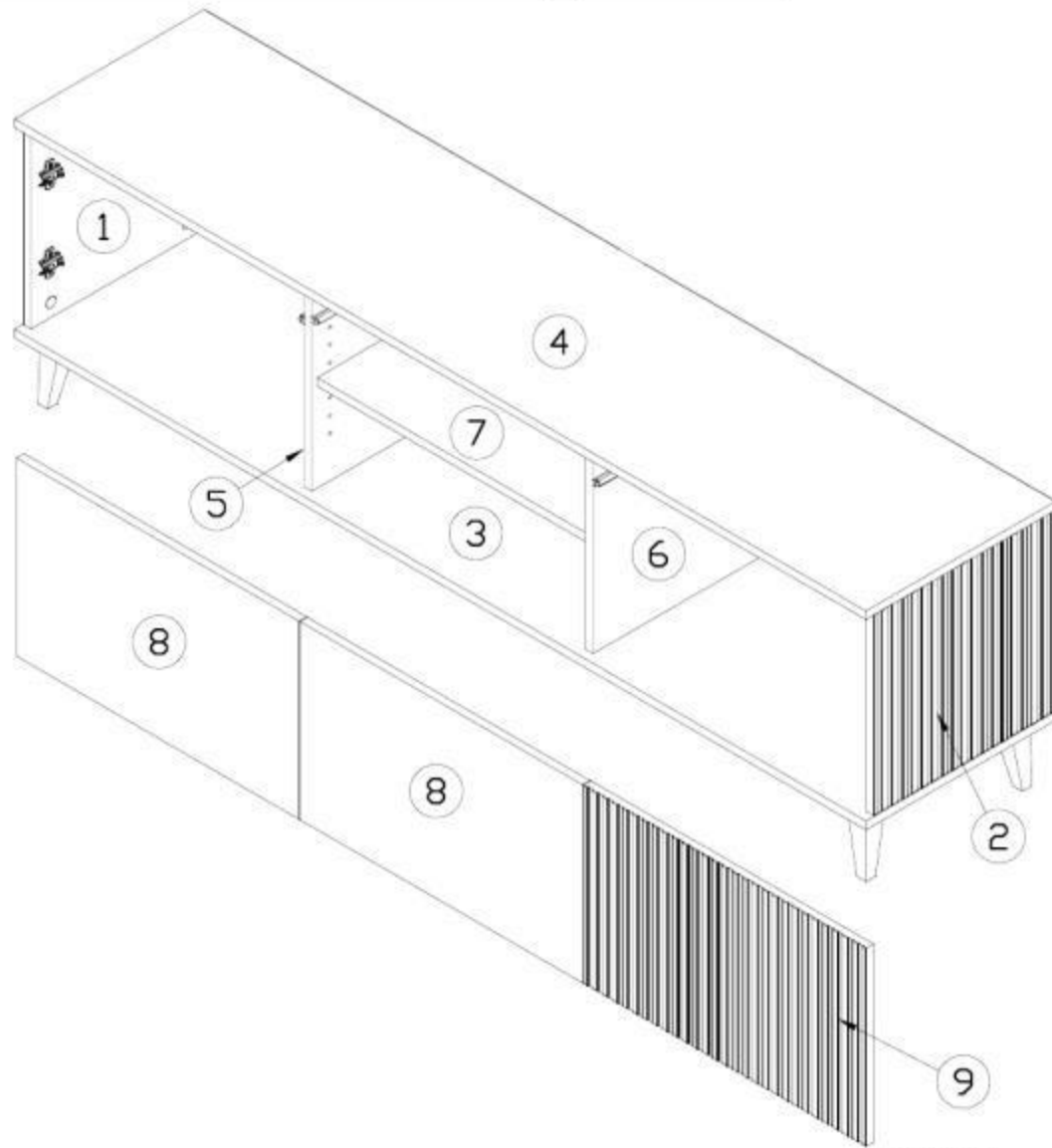
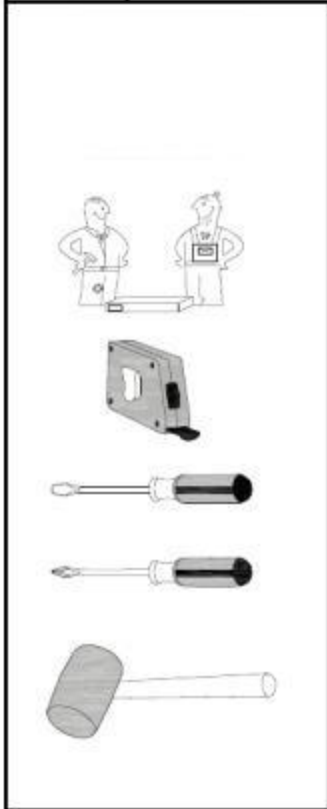
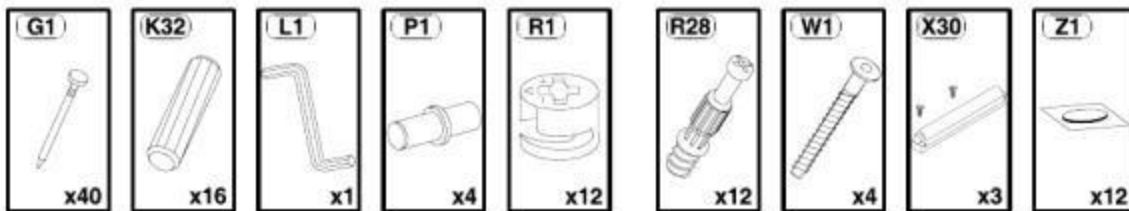

BAG 2

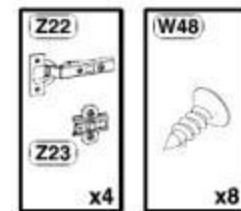

BAG 3

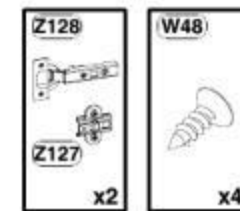

BAG 4

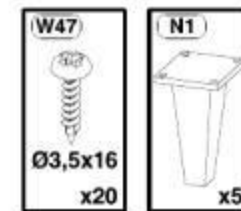

BAG 5



Model:

RANDOM RTV 180

2/11

1

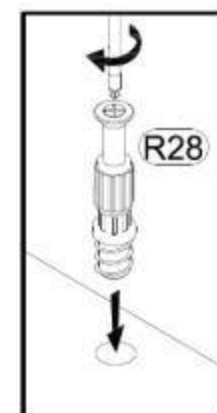
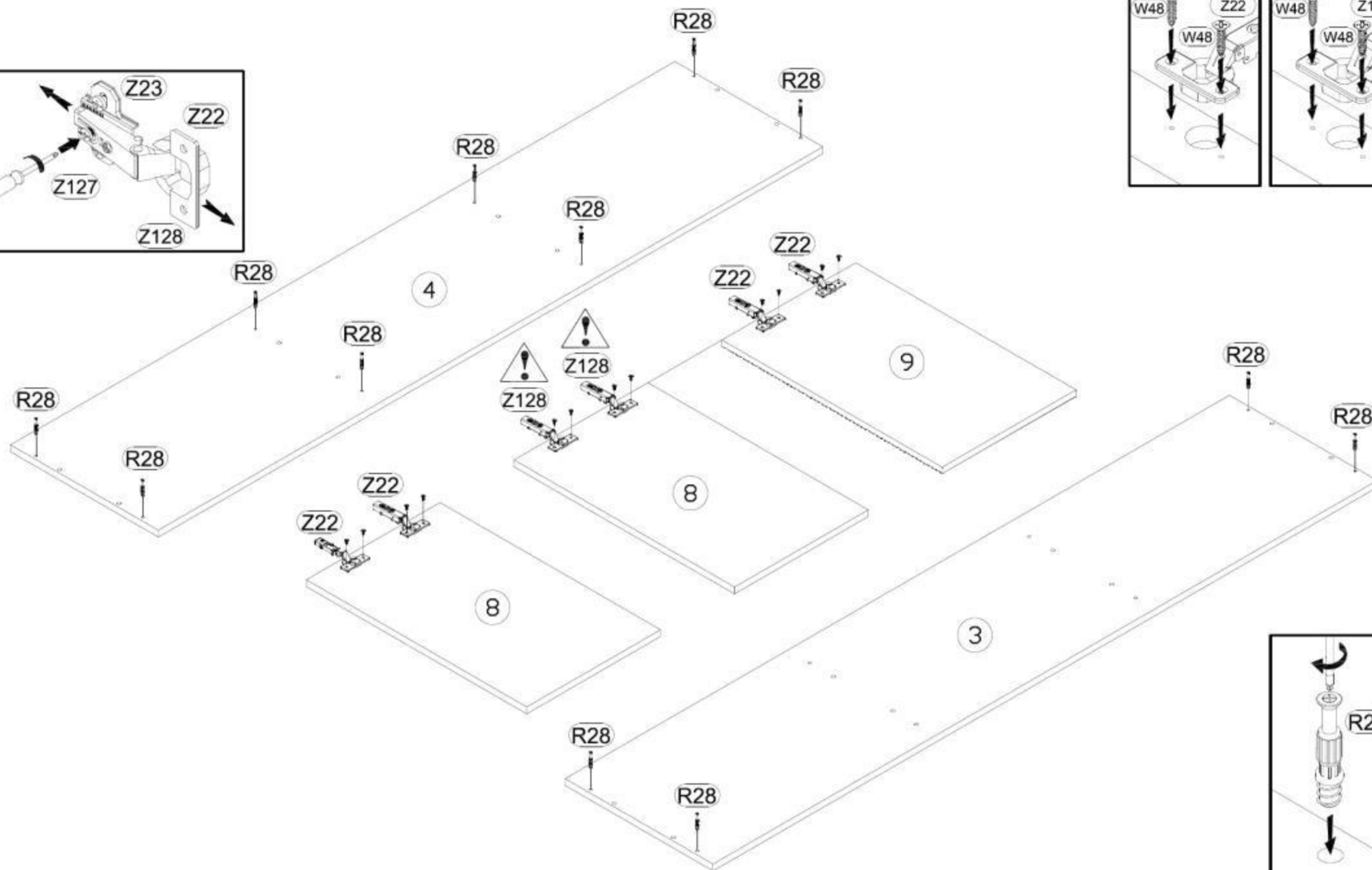
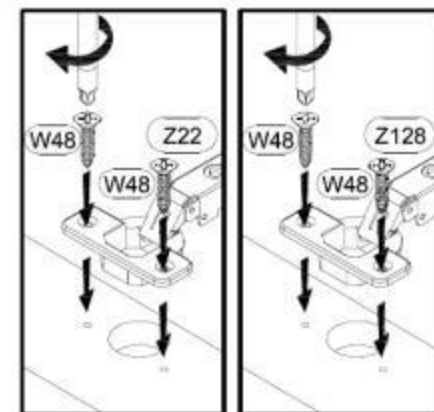
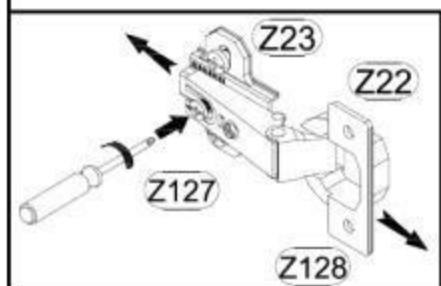

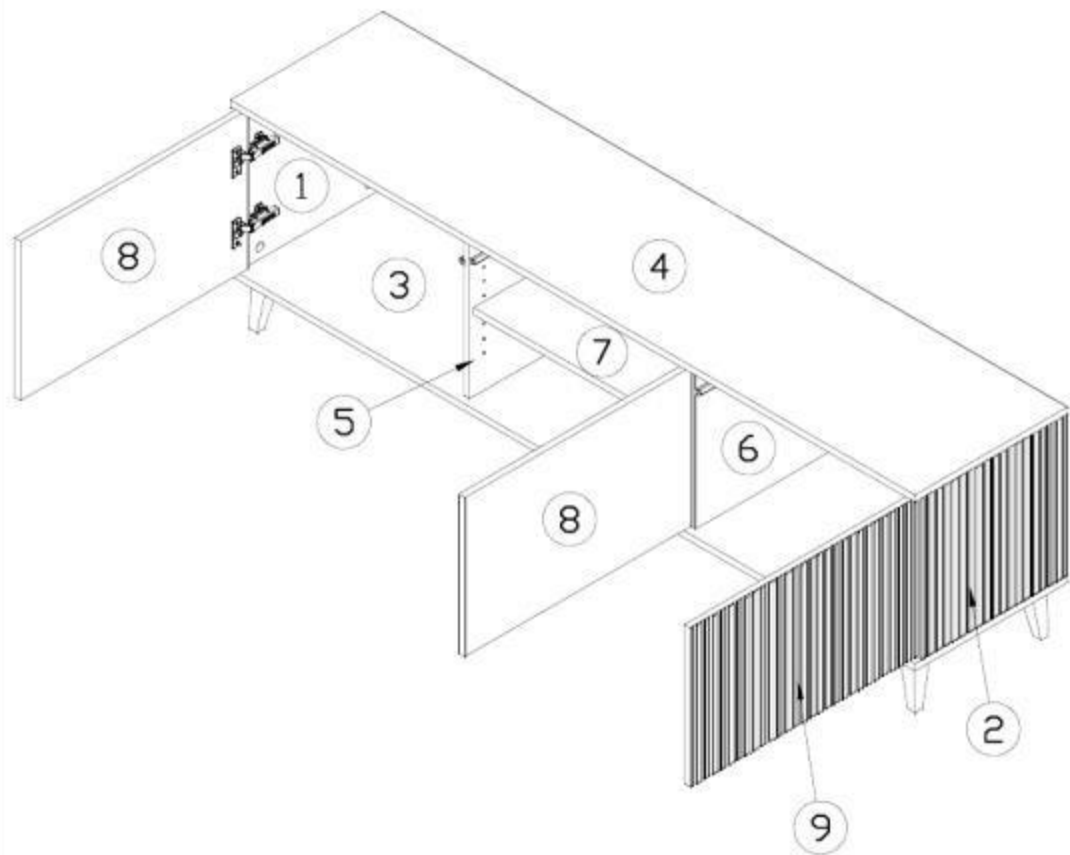

"RIGHT" 2-5

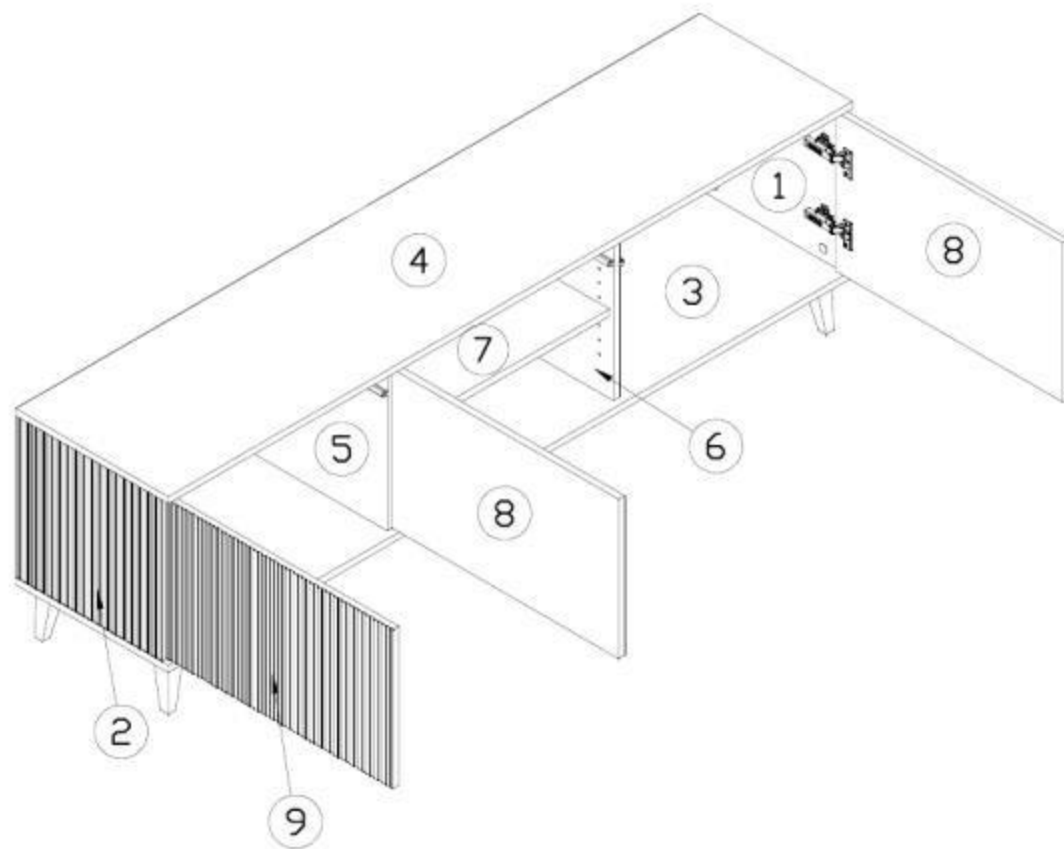

"LEFT" 6-9

2

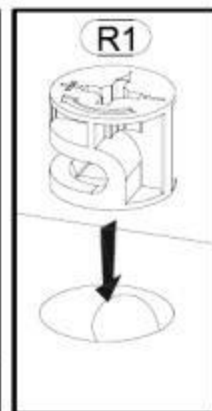
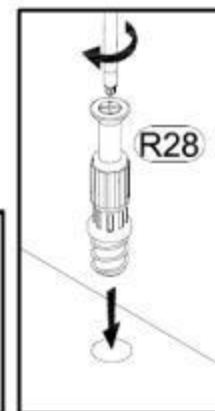
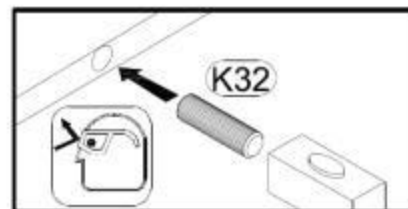
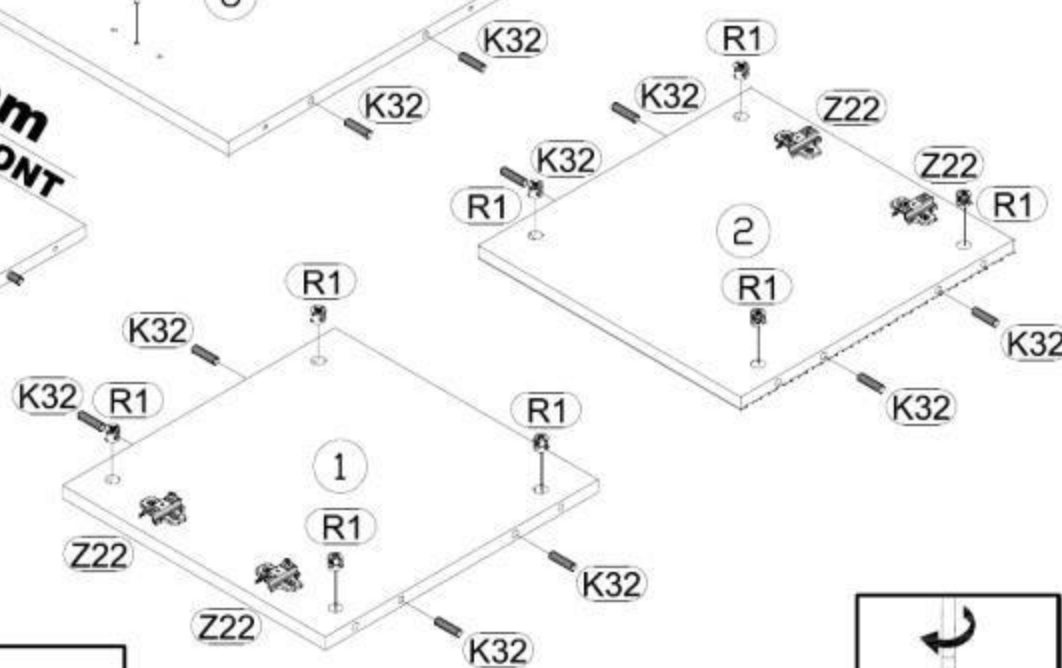
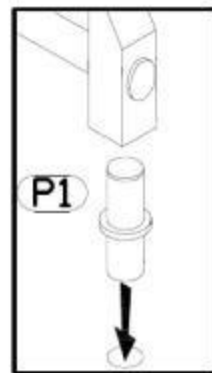
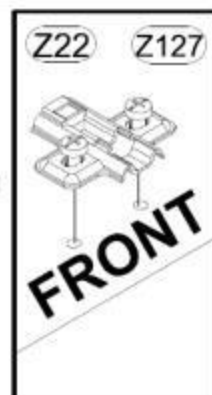
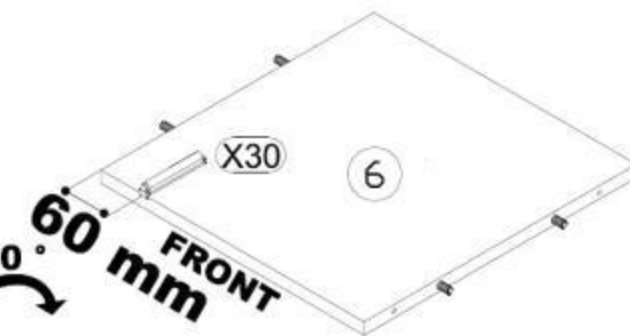
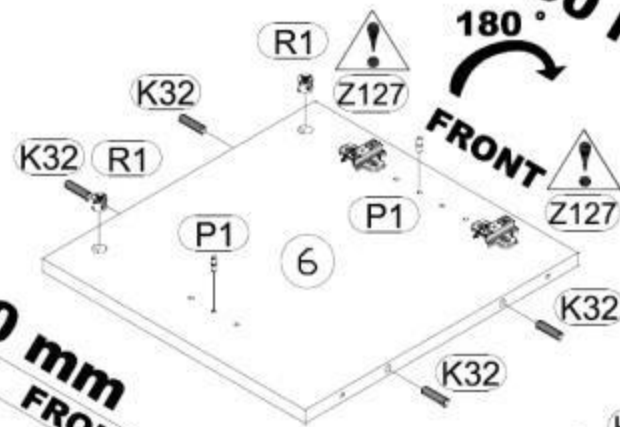
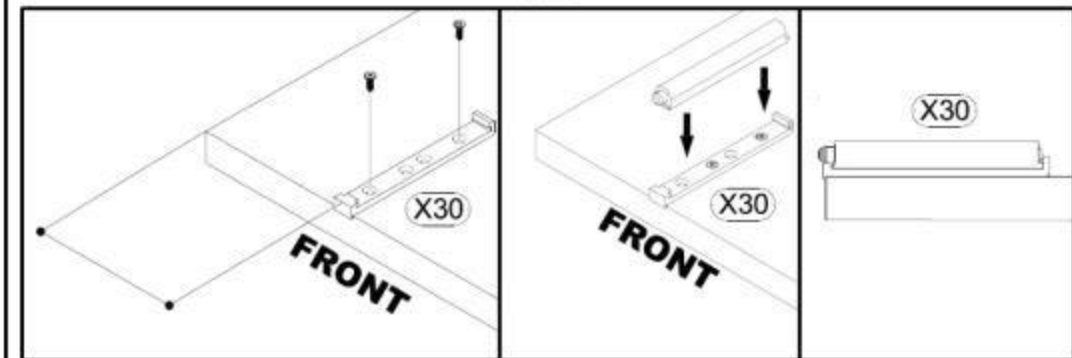
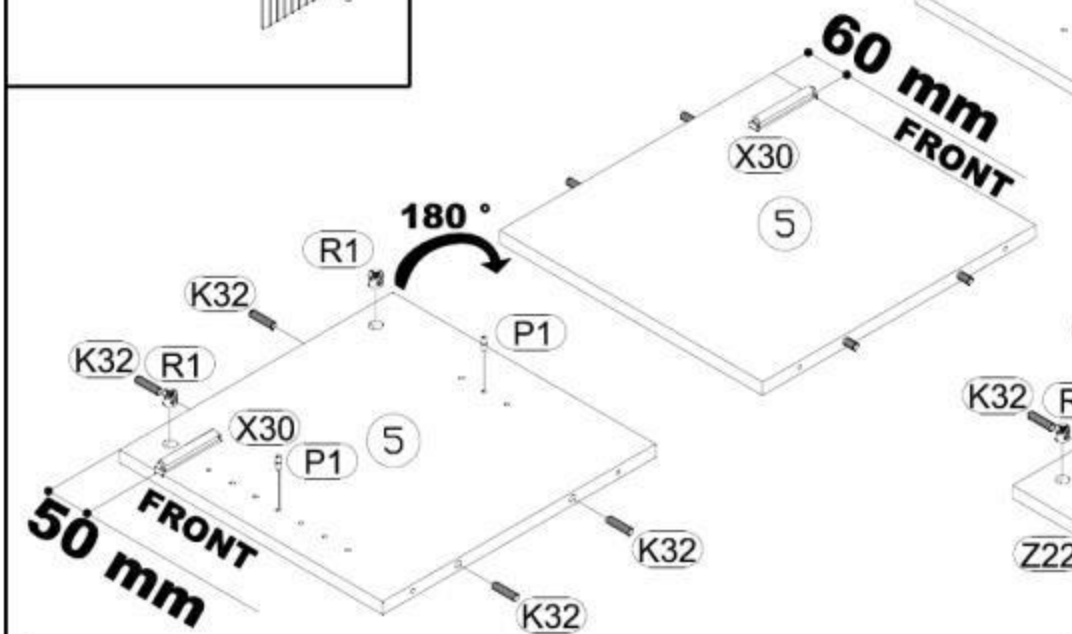
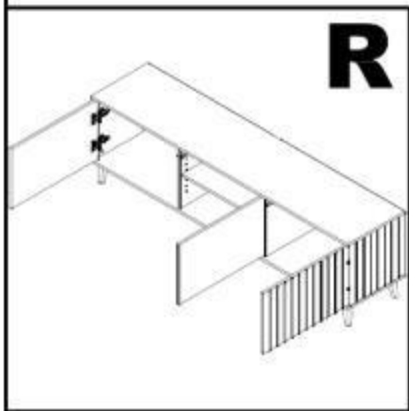

Model:

RANDOM TV 180

5/11

3

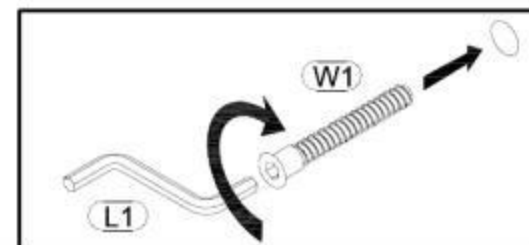
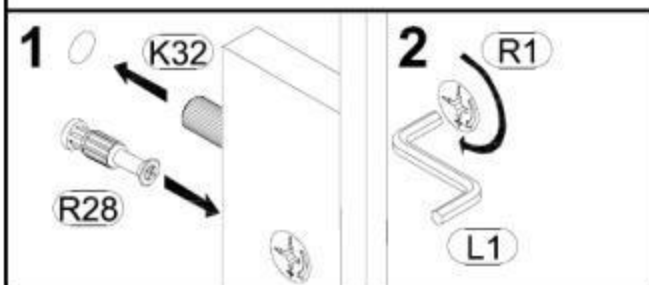
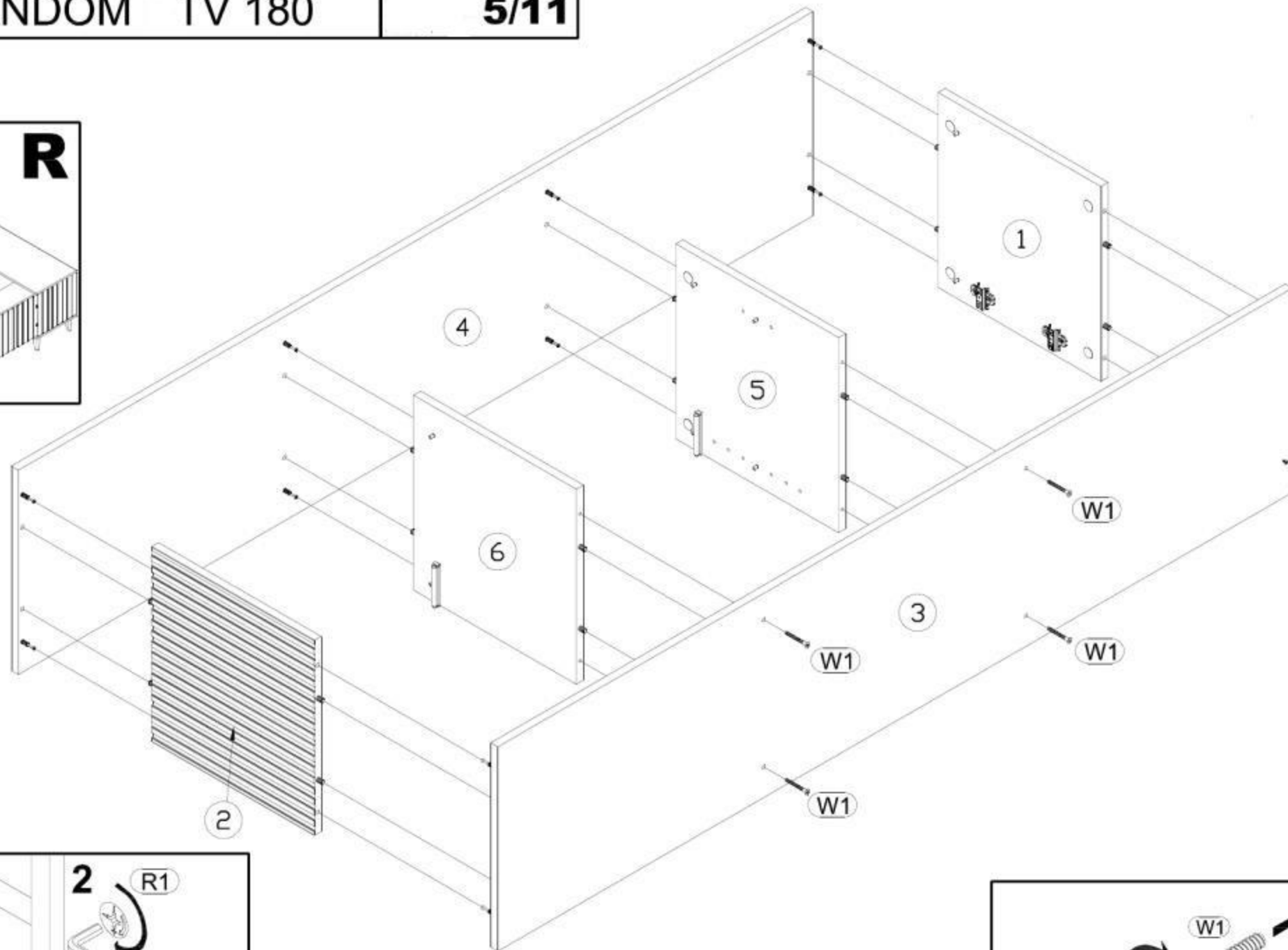
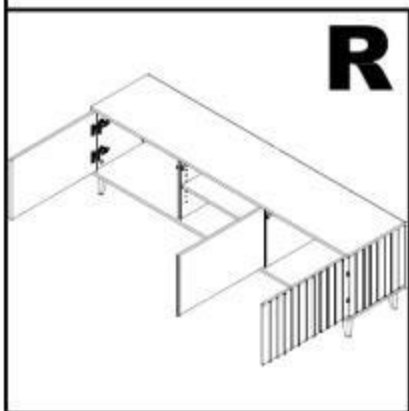

Model:

RANDOM TV 180

6/11

4

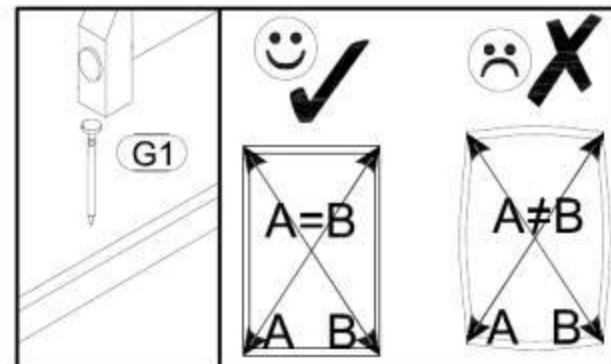
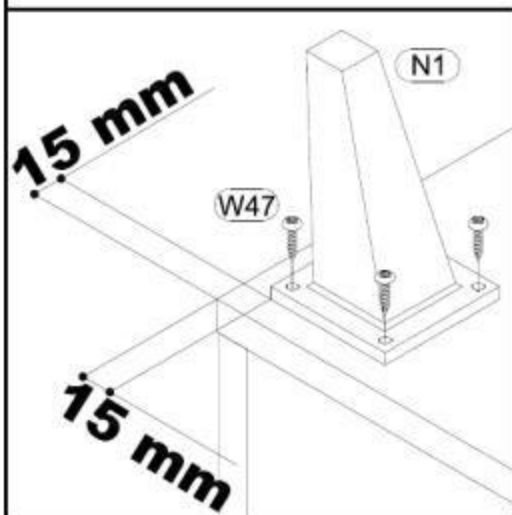
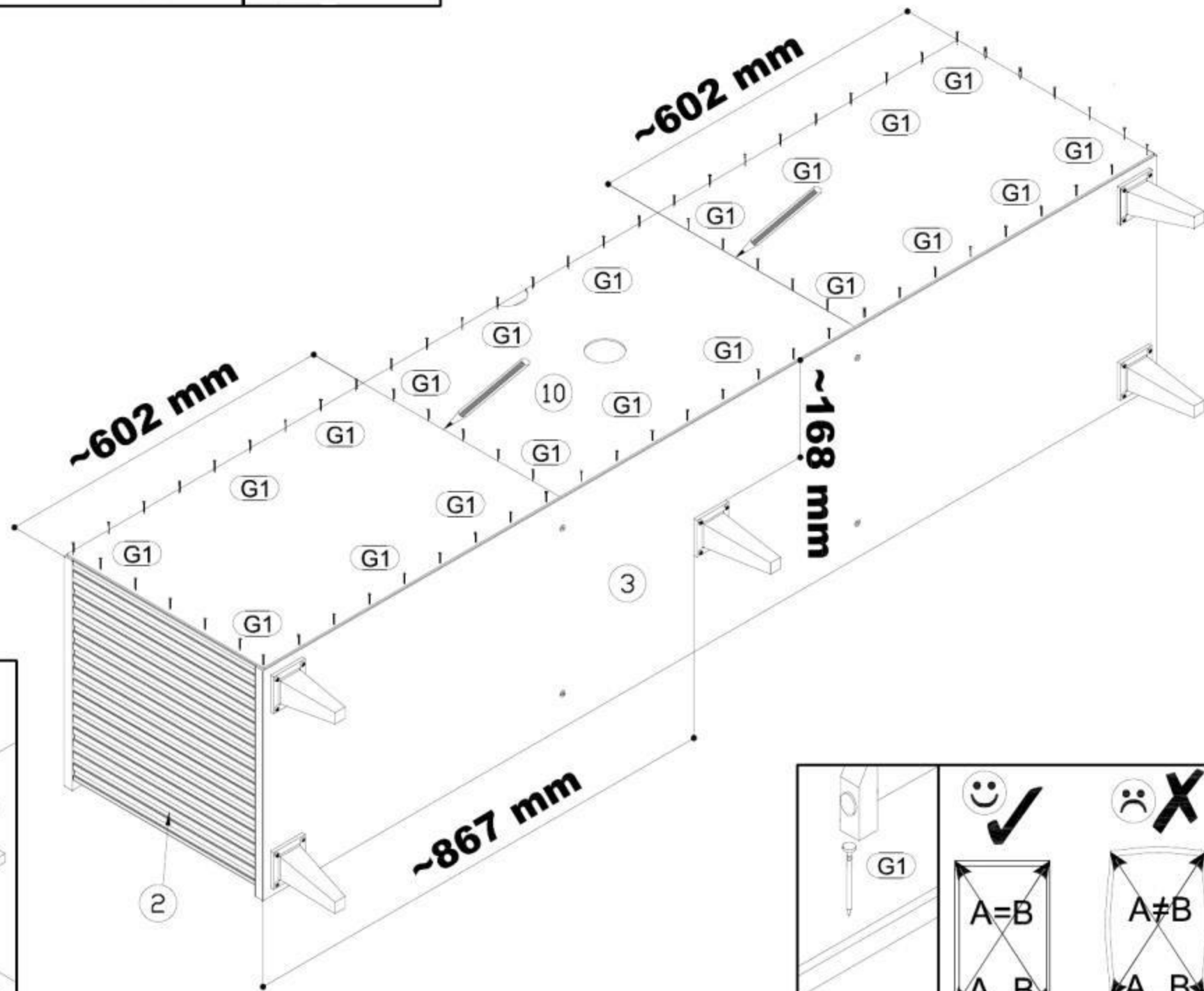
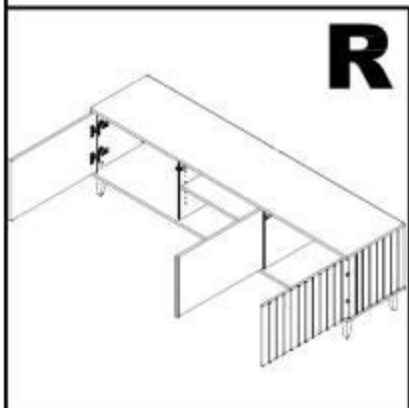

Model:

RANDOM TV 180

7/11

5

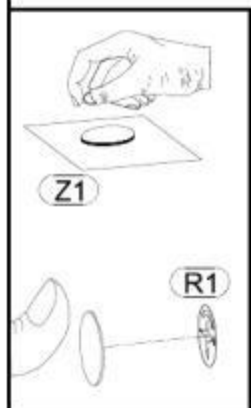
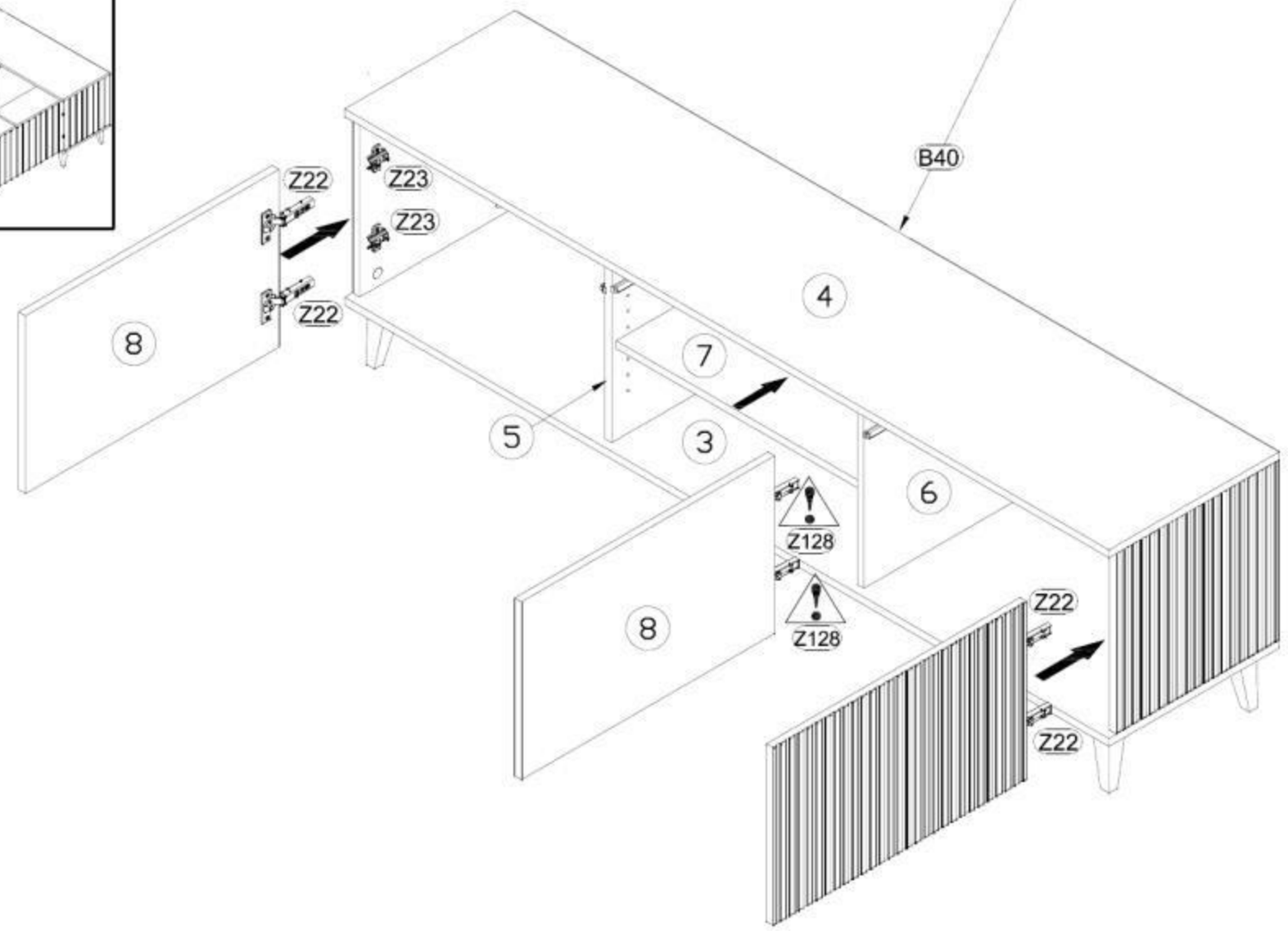
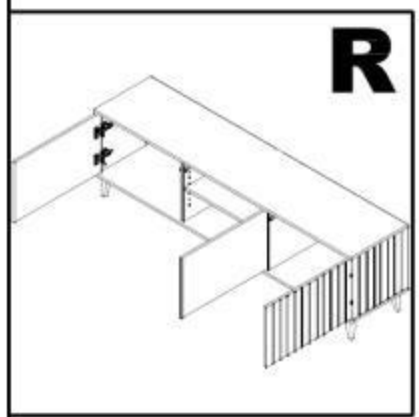
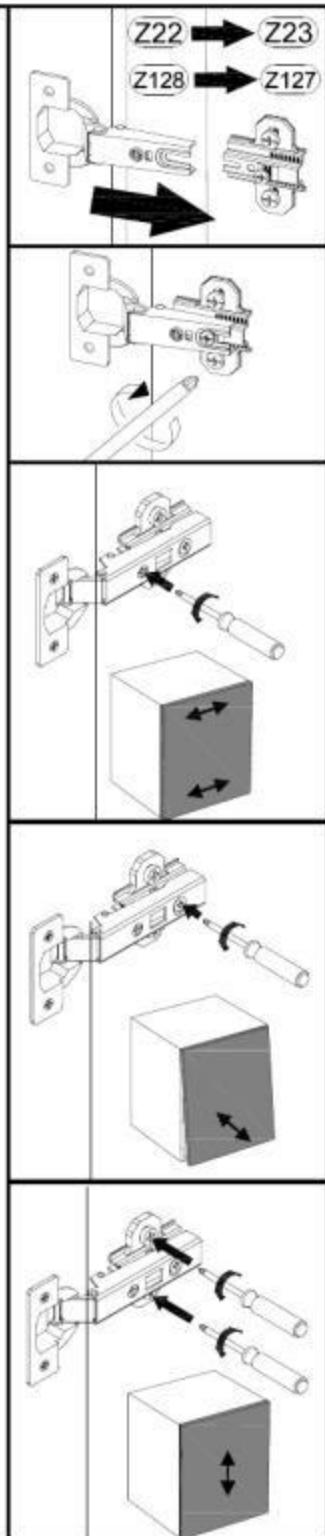
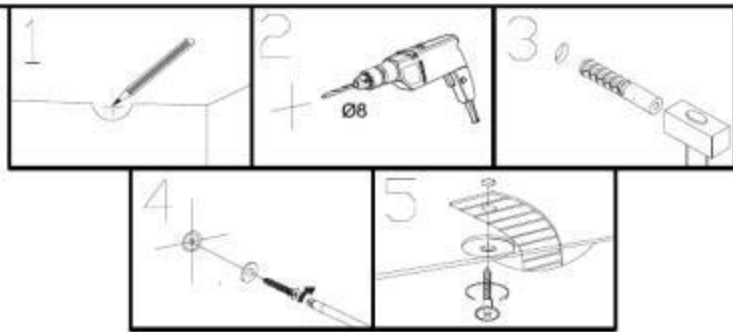

6

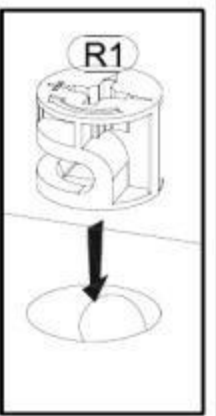
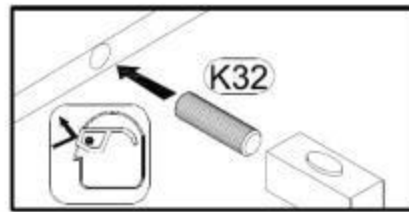
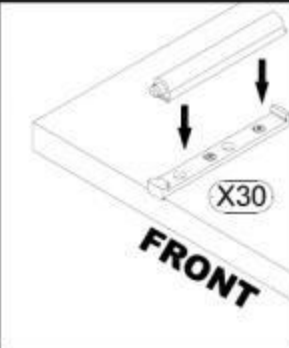
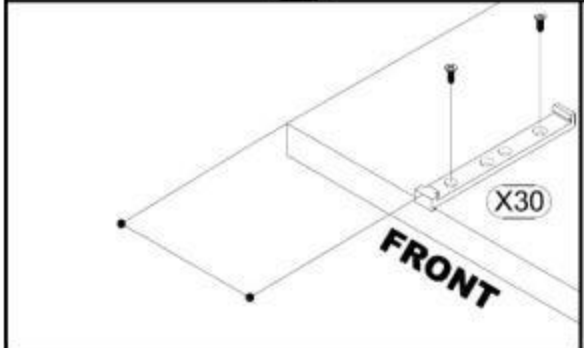
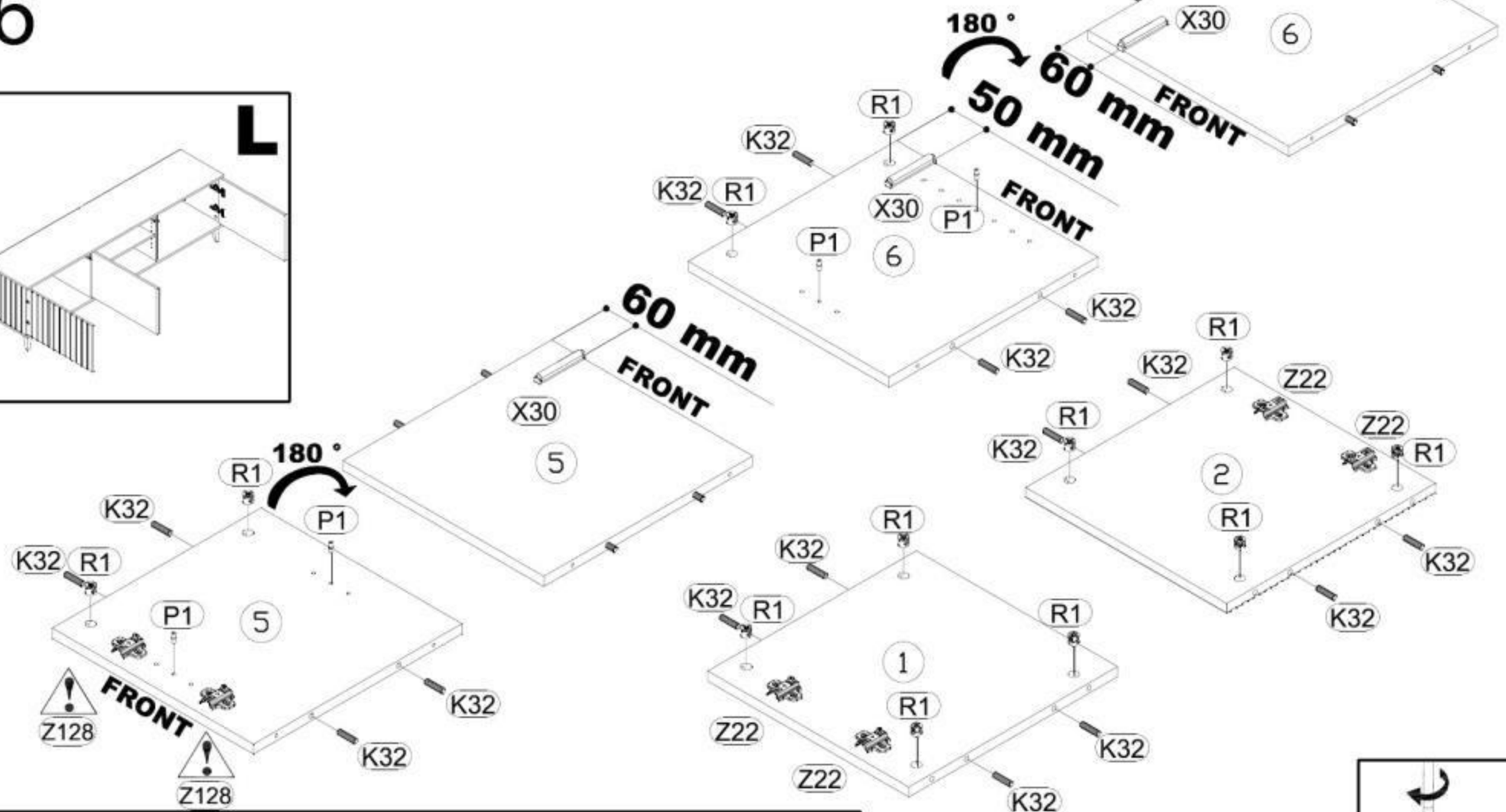
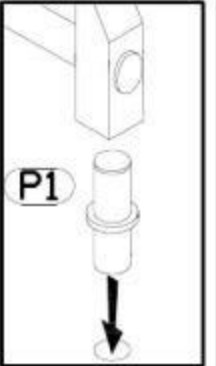
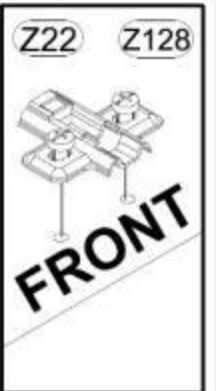
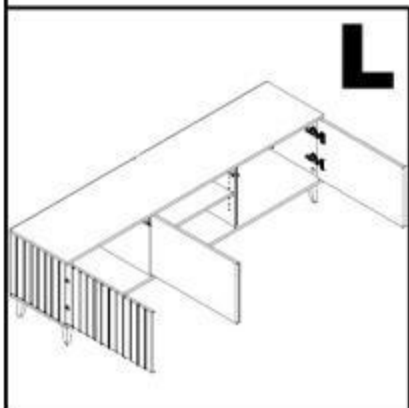

7

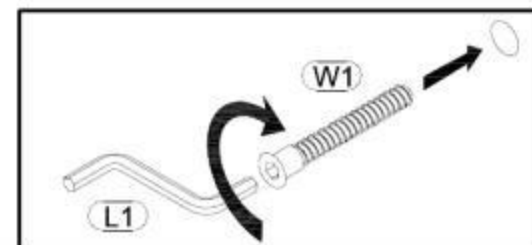
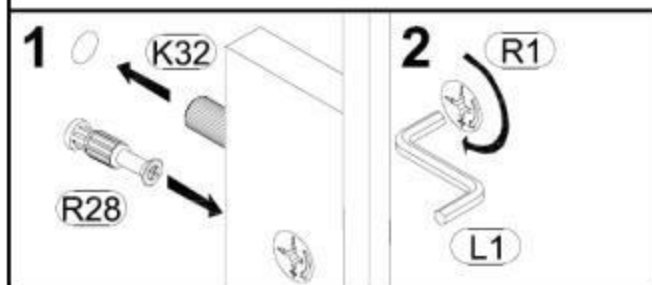
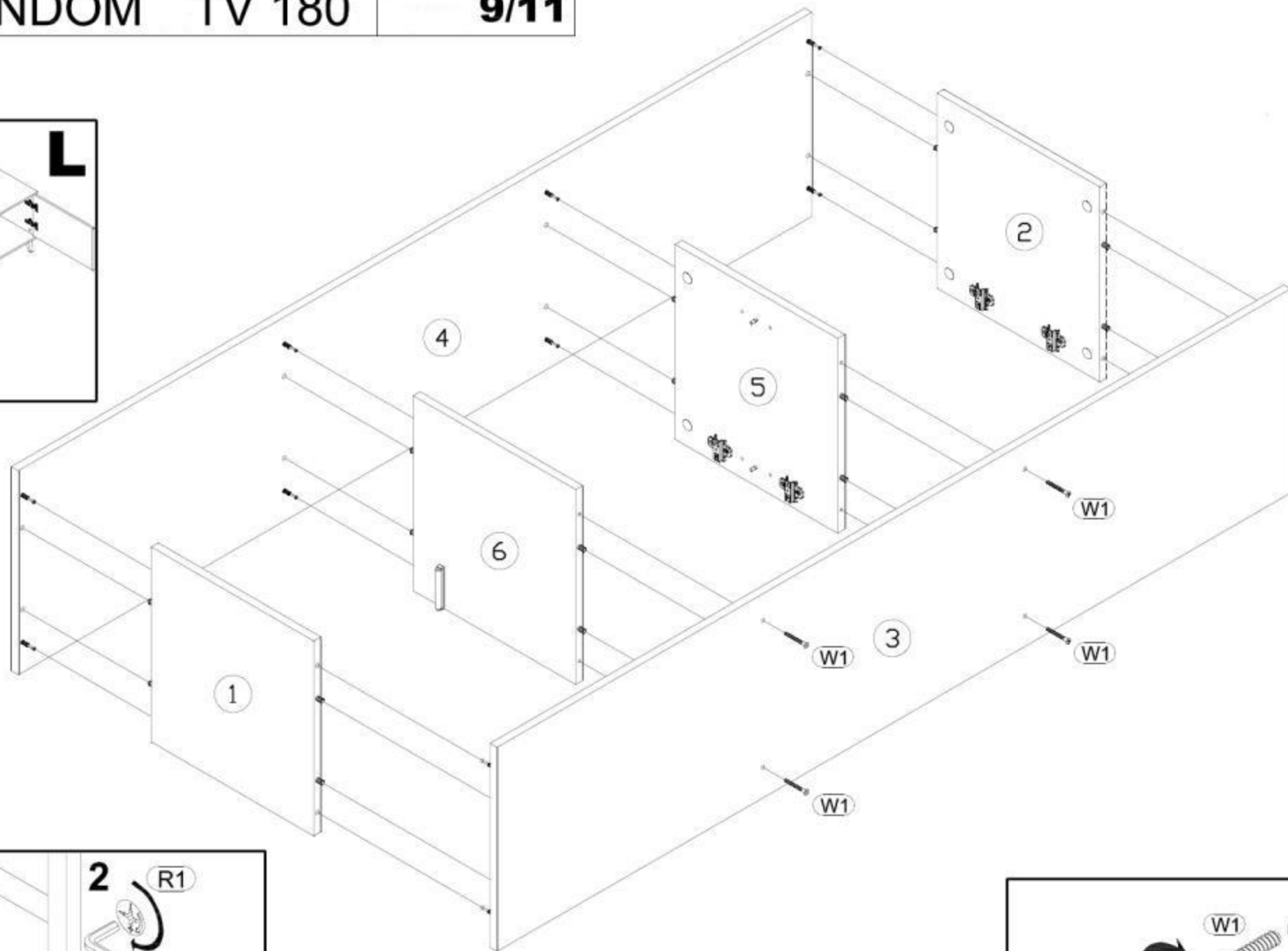
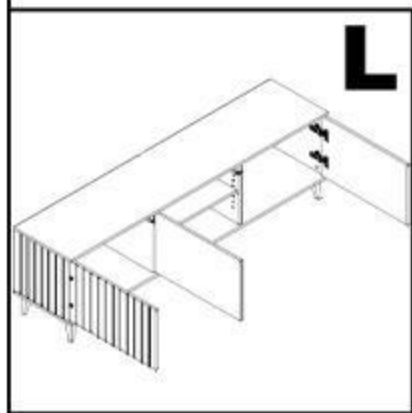

8

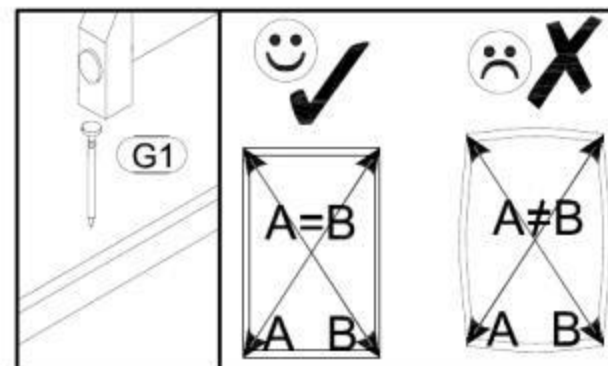
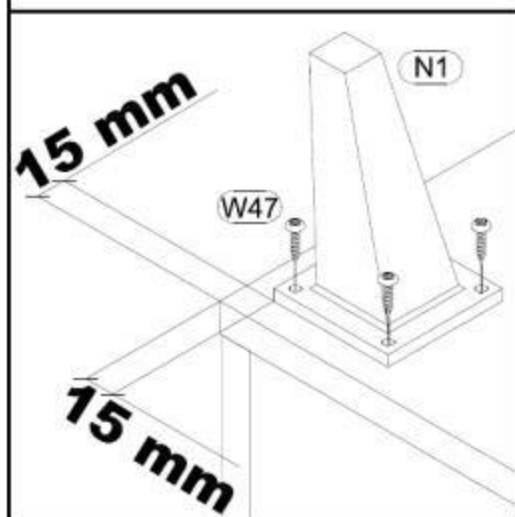
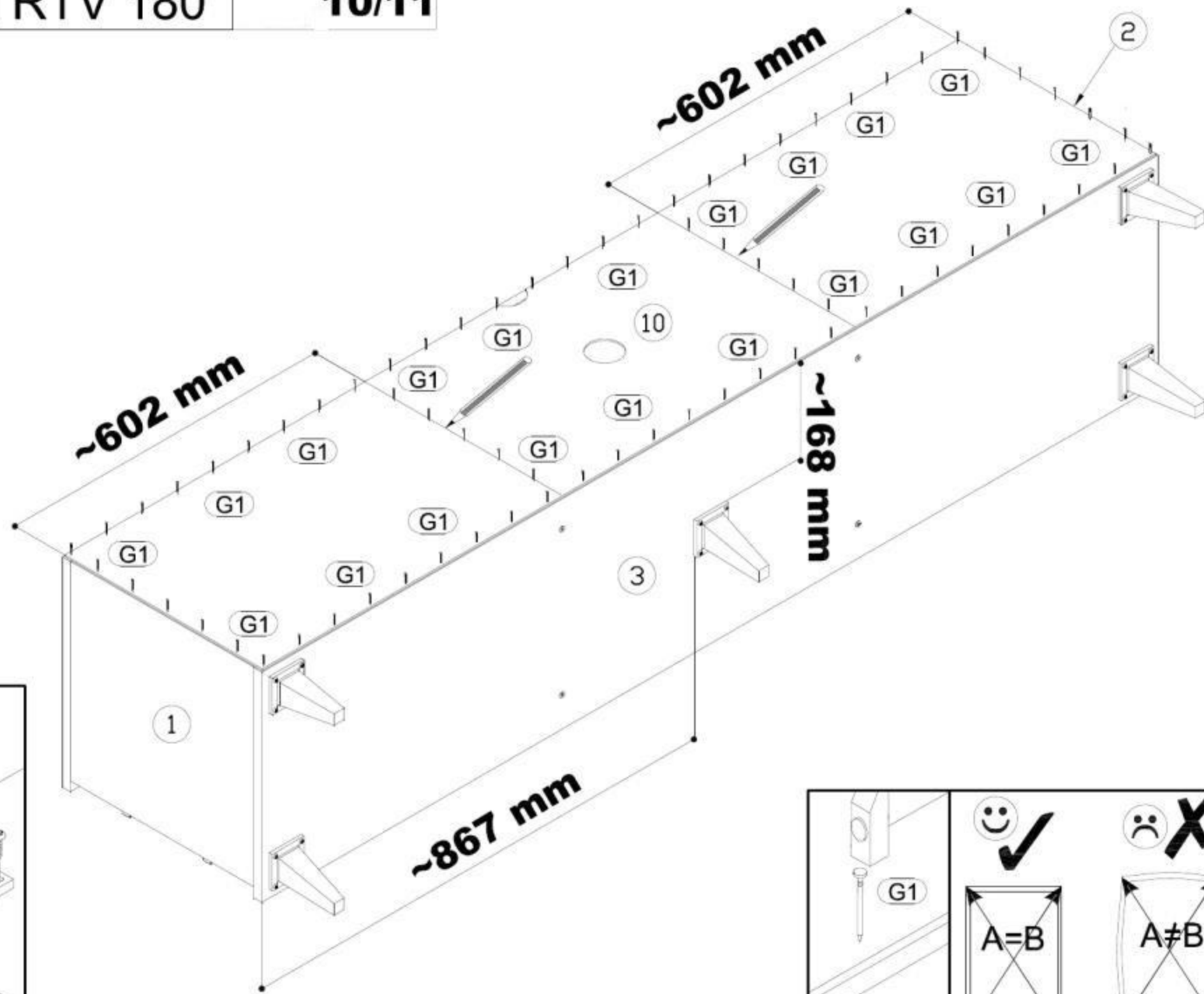
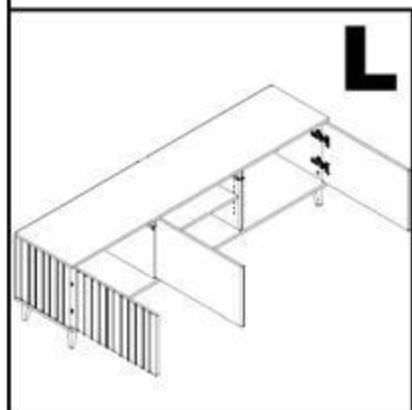

9

