

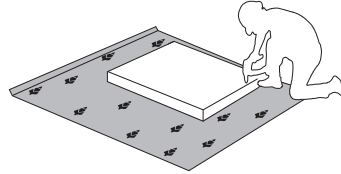

IMPORTANT - READ CAREFULLY - RETAIN FOR FUTURE REFERENCE
 WICHTIG - SORGFÄLTIG LESEN UND AUFBEWAHREN

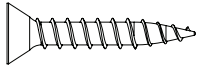
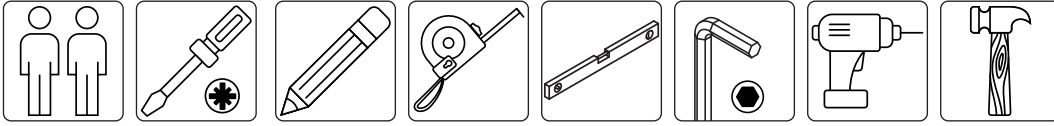
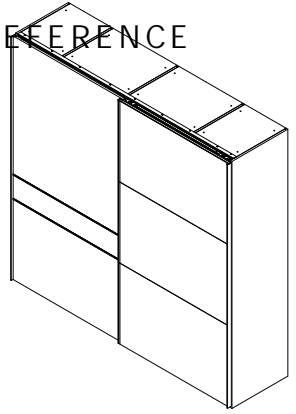

PK231-OG/ON
 LWH - 2294x611x2236

- | | | | | | | | | | |
|-------------------------|----------------------------------|--------------------------------|--------------------------|------------------------|----------------------------|-------------------------------|----------------------------------|-----------------------------------|--------------------------------|
| x42
2149
 | x32
0063
Ø15x13
 | x8
0064
Ø8x24
 | x48
16535
 | x16
0102
 | x32
EKSK4-BE
 | x2
2114
4x35
 | x90
0094
3.5x16
 | x52
31777
4.2x16
 | x62
0096
4x18
 |
| x2
1321
 | x2
31533
 | x2
36918
 | x2
26102
 | x1
46945
 | x1
46948
 | x1
0113
GLUE
 | | | |
| x2
32286
 | x1
46950
 | | x10
NPVC75
 | | x1
46953
 | | | | |
| x28
CEP8
 | x48
FAH-16
 | x50
0122
 | x12
32245
 | | | | | | |
| x8
0104
 | x2
10397
 | | | | | | | | |
| x42
36894
 | | x6
47900
 | | | | | | | |

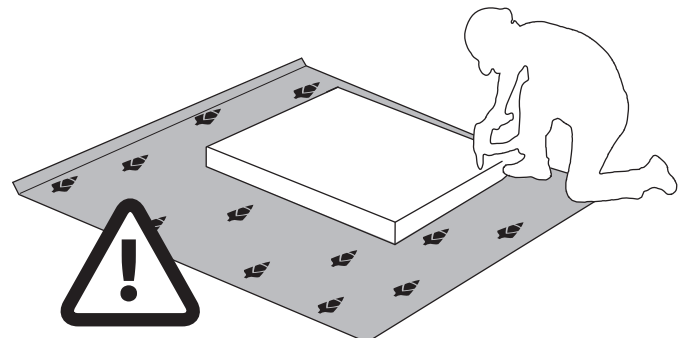

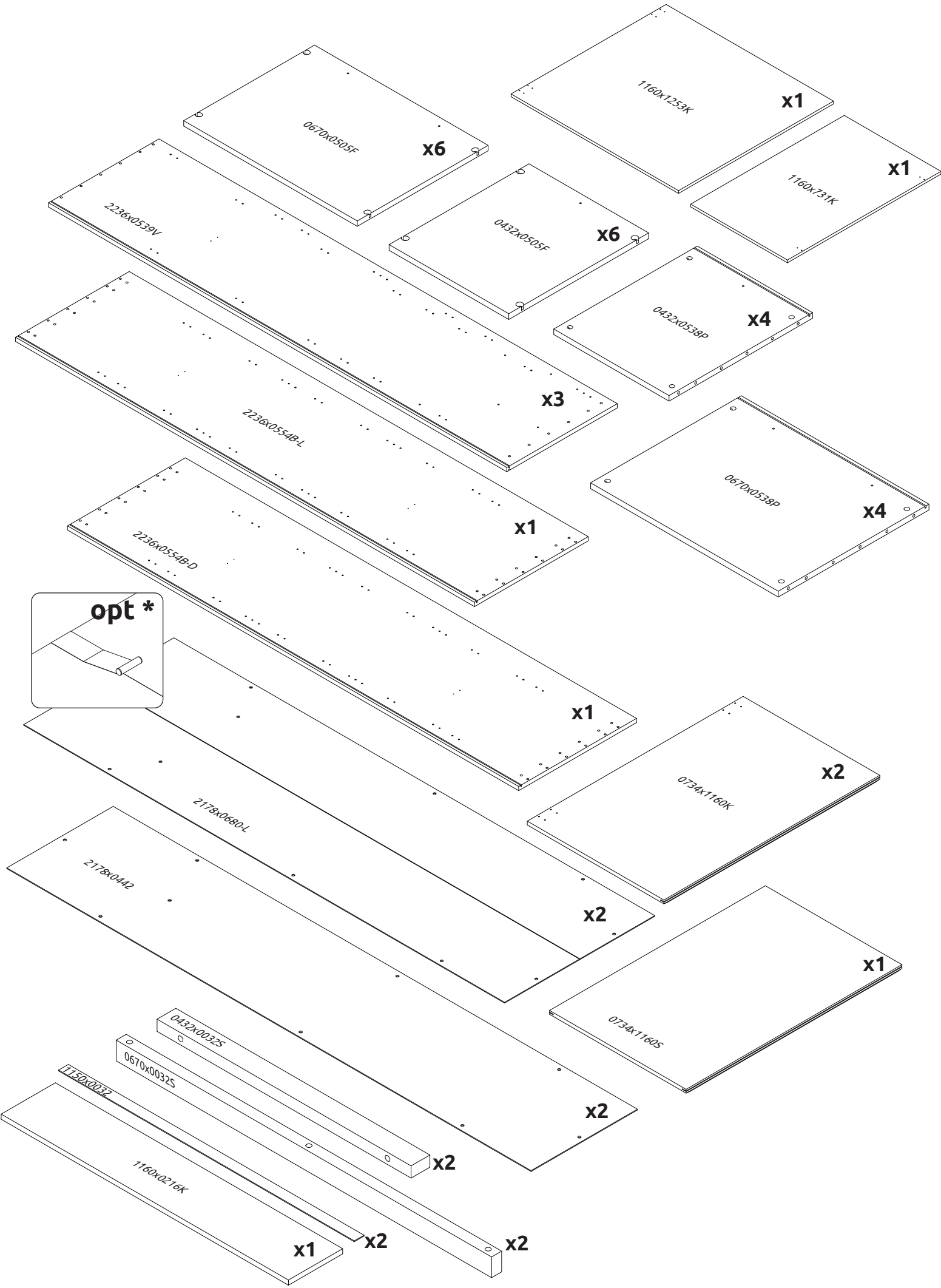

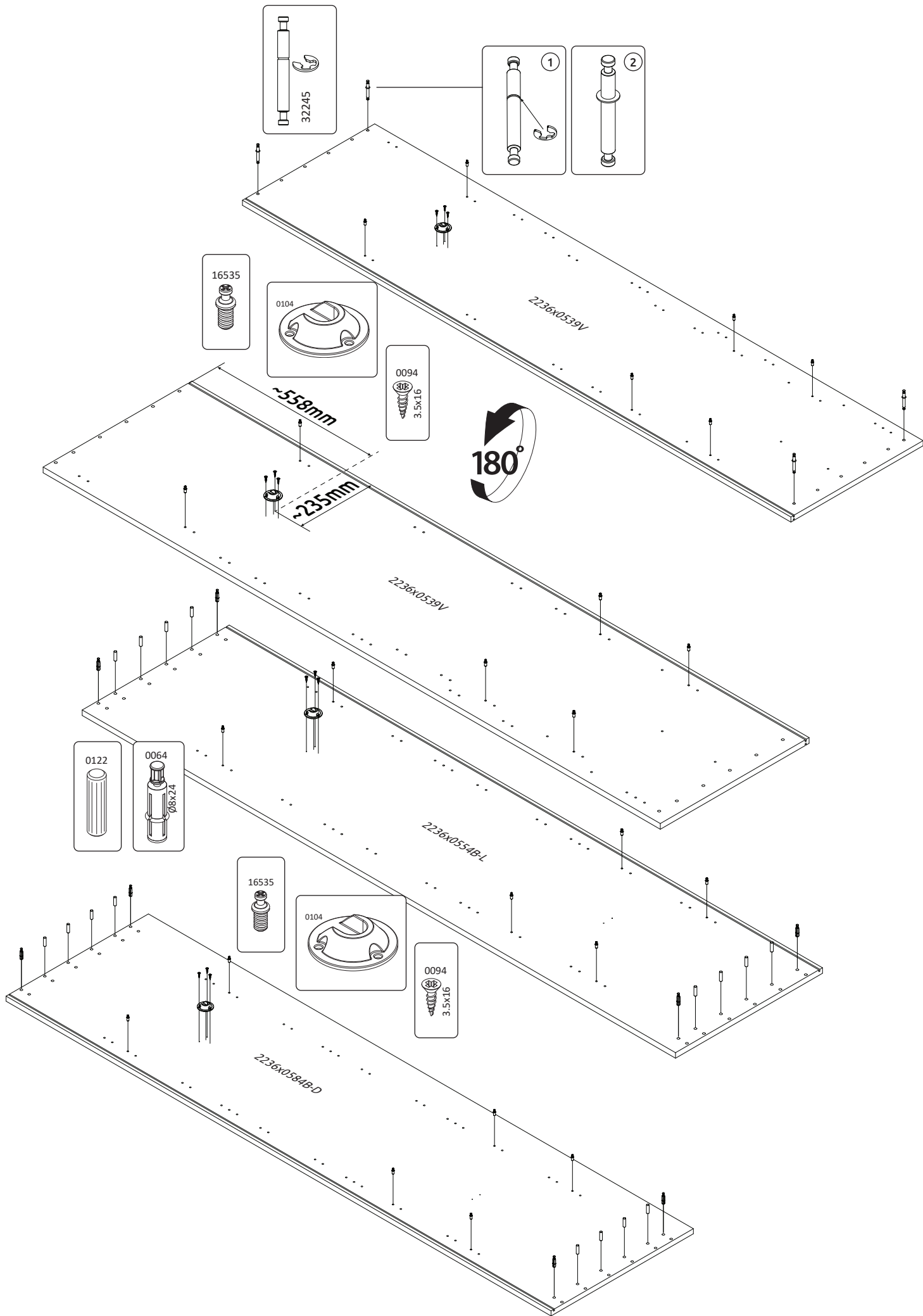

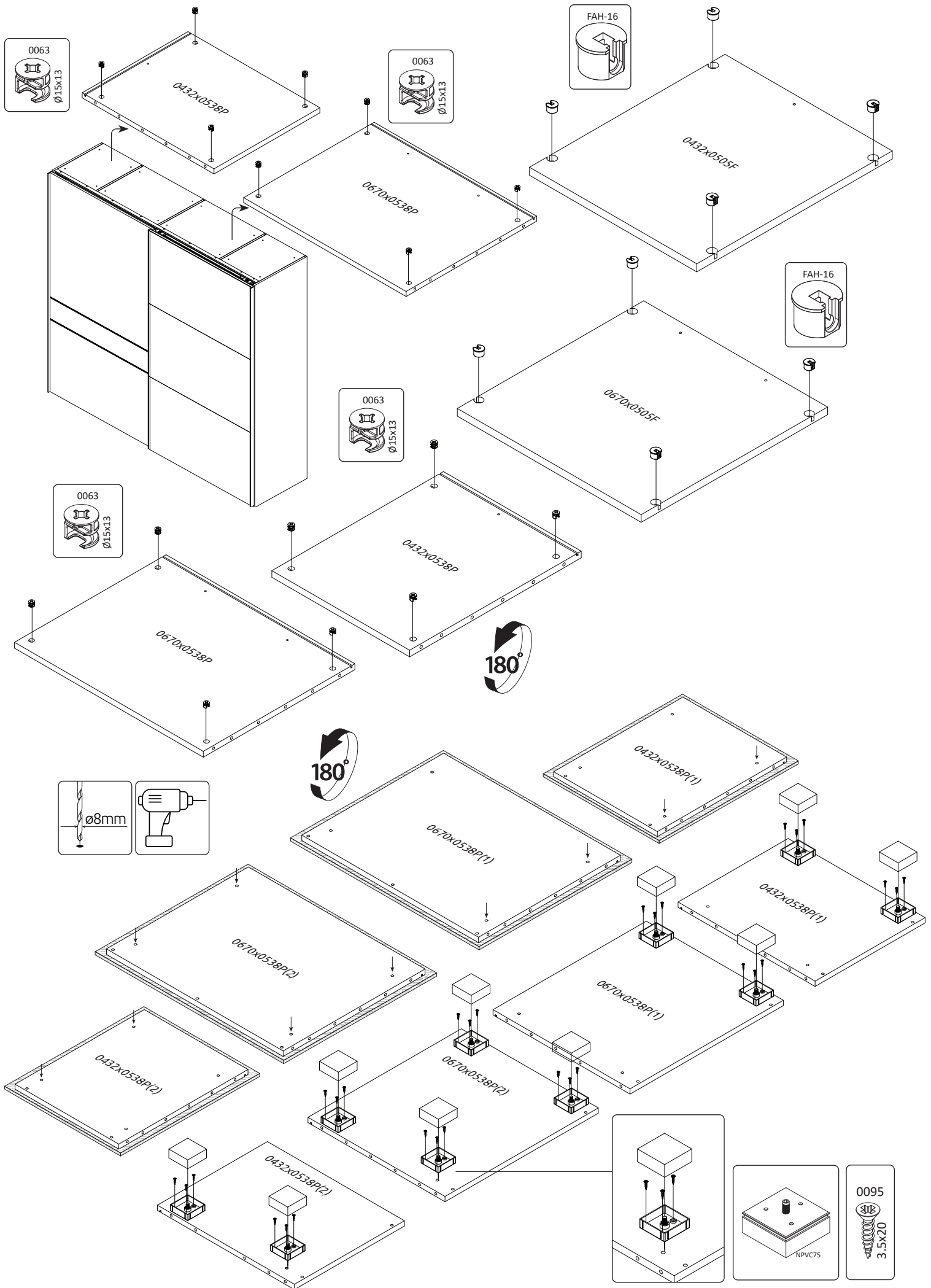

1

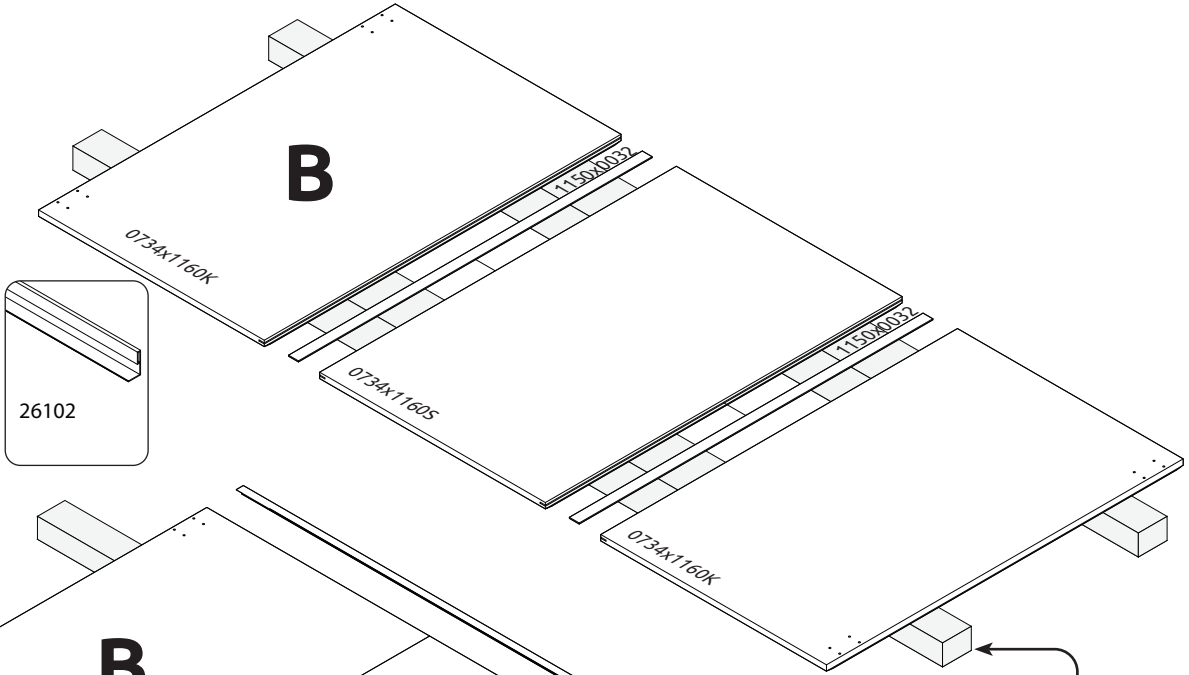

2

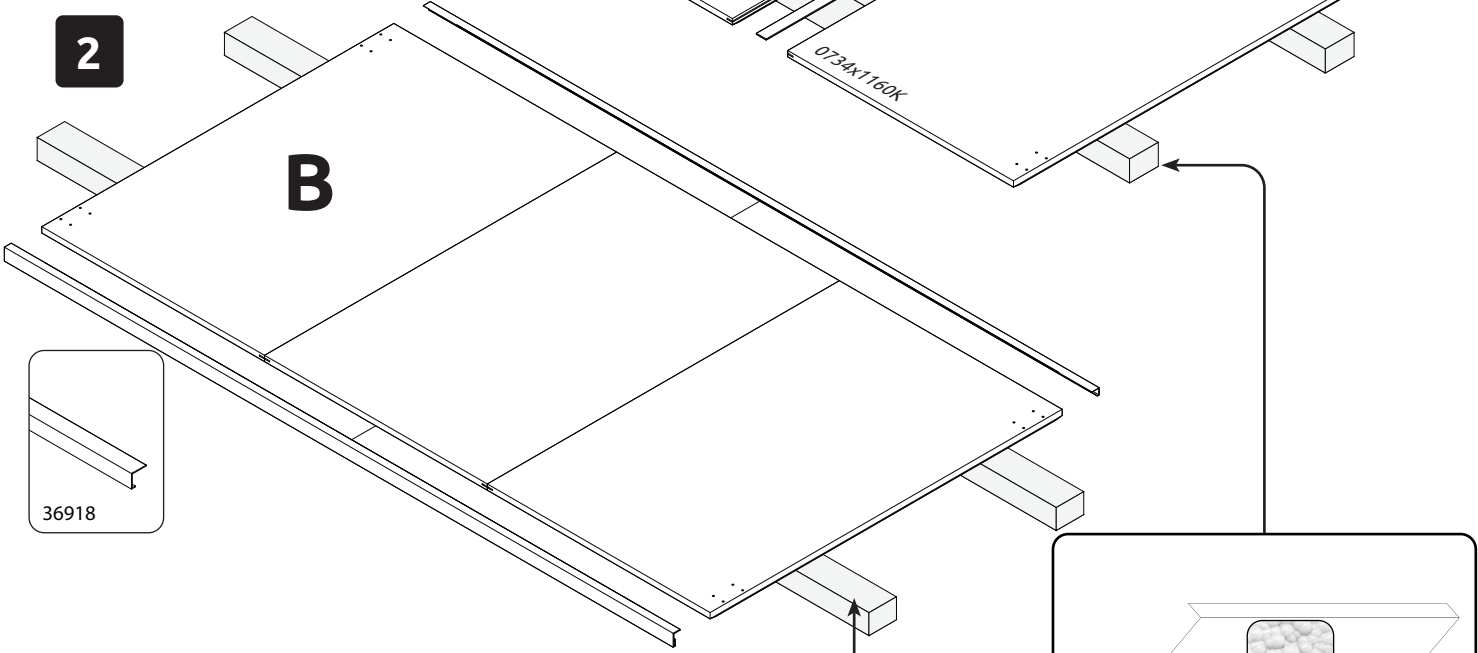

3

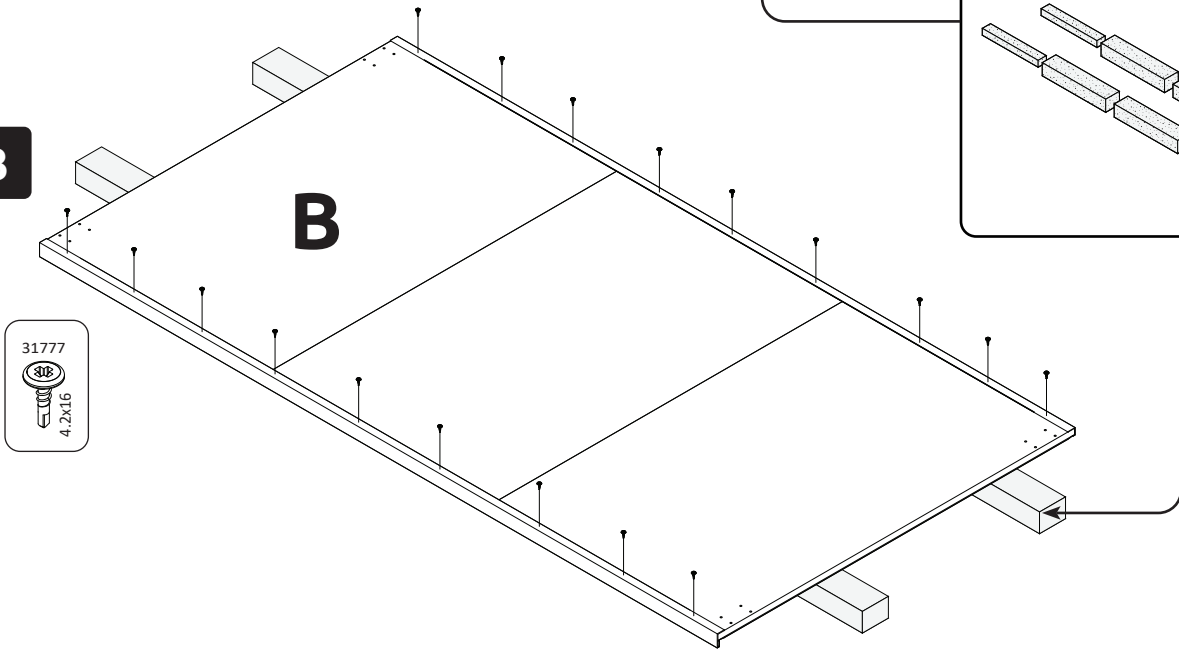

4

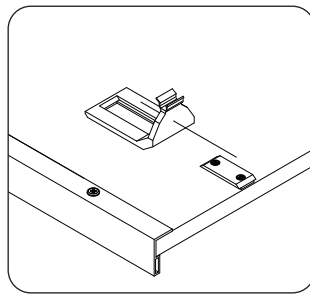
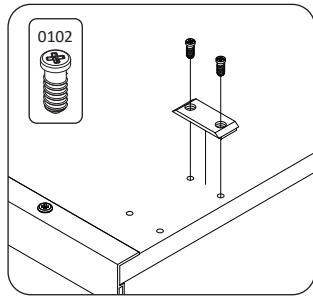
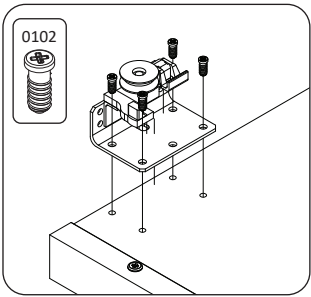
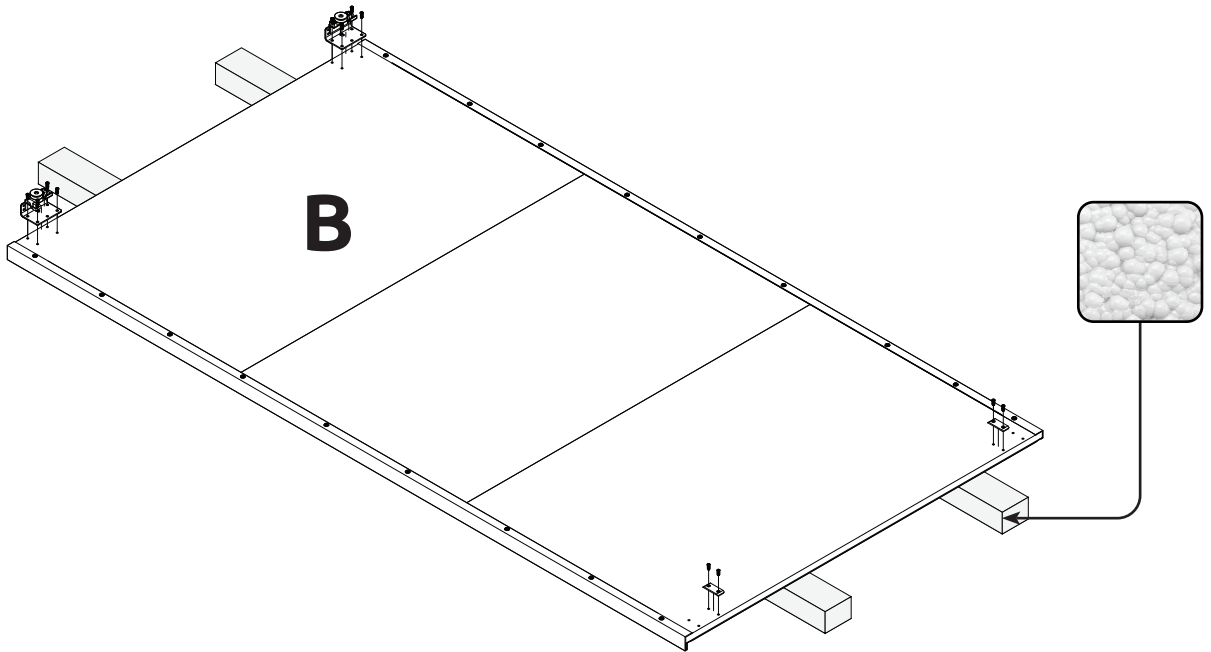

5

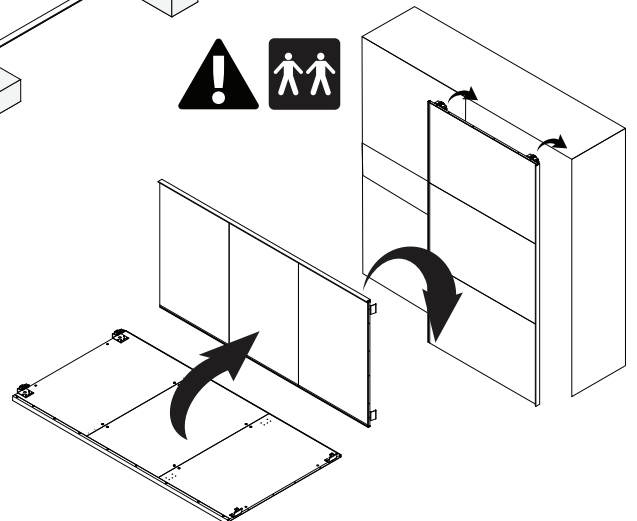
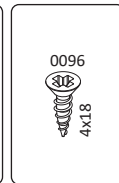
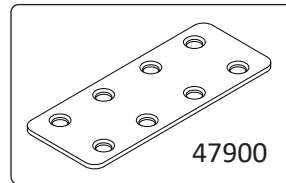
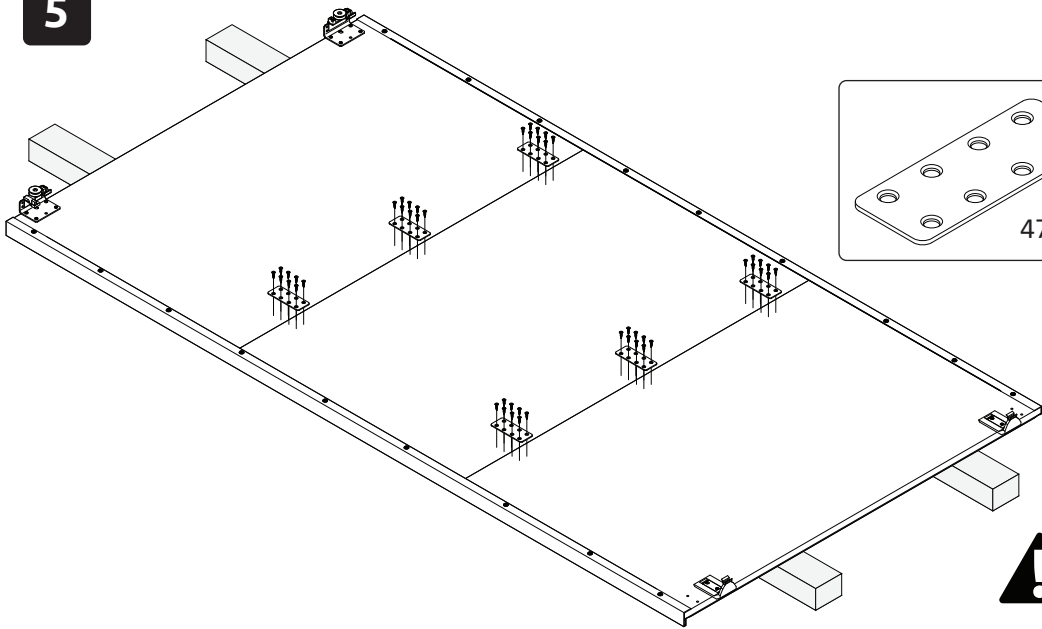

6

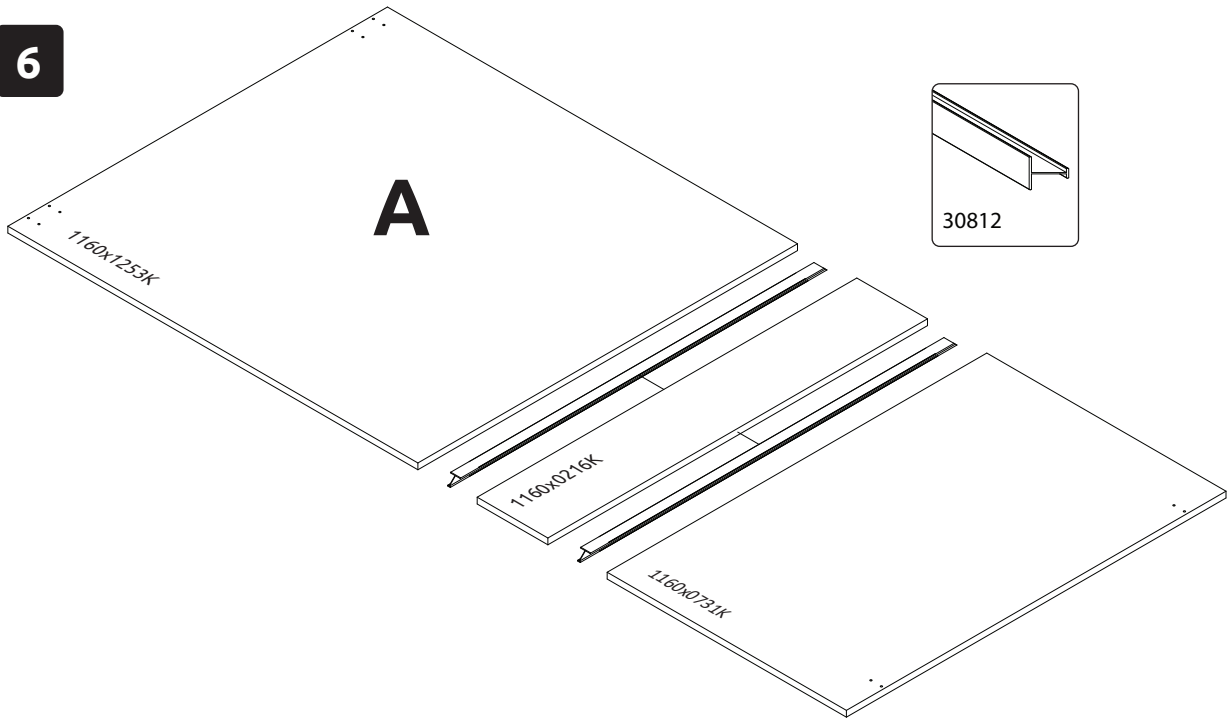

7

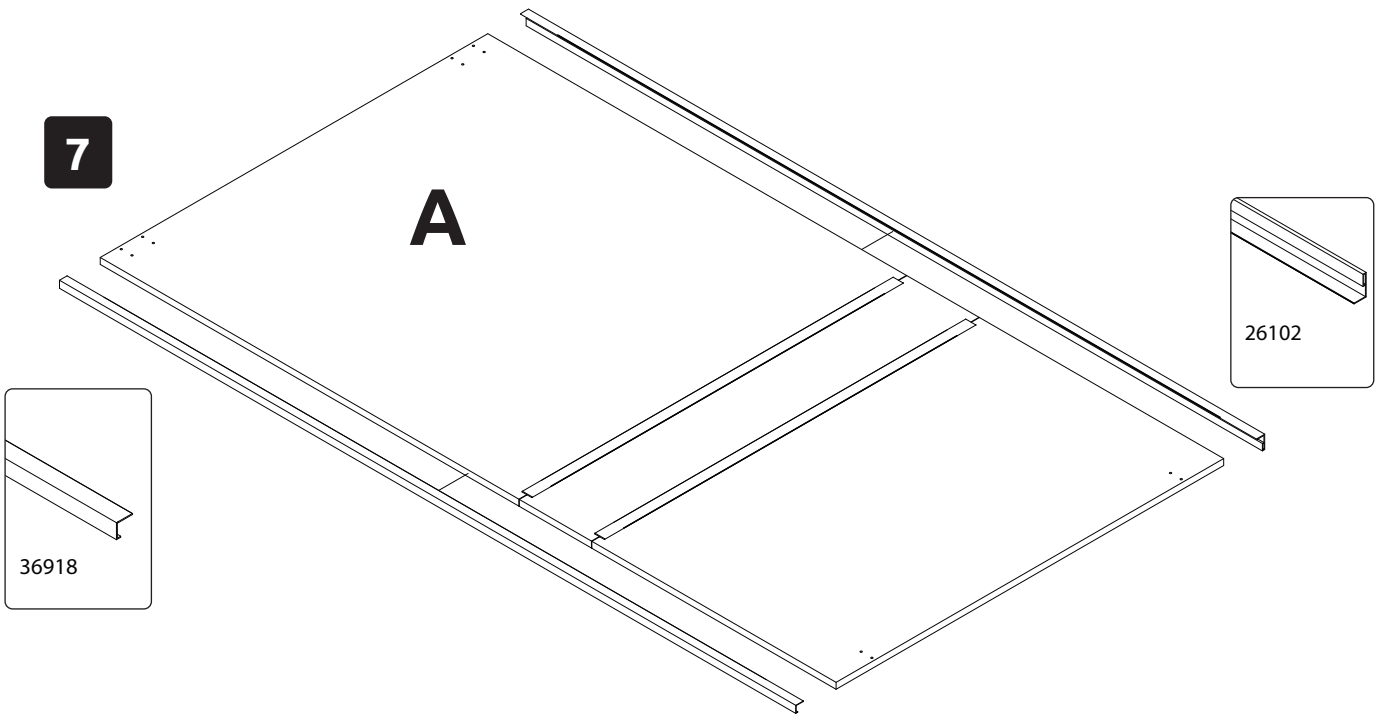

8

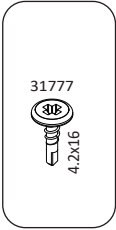
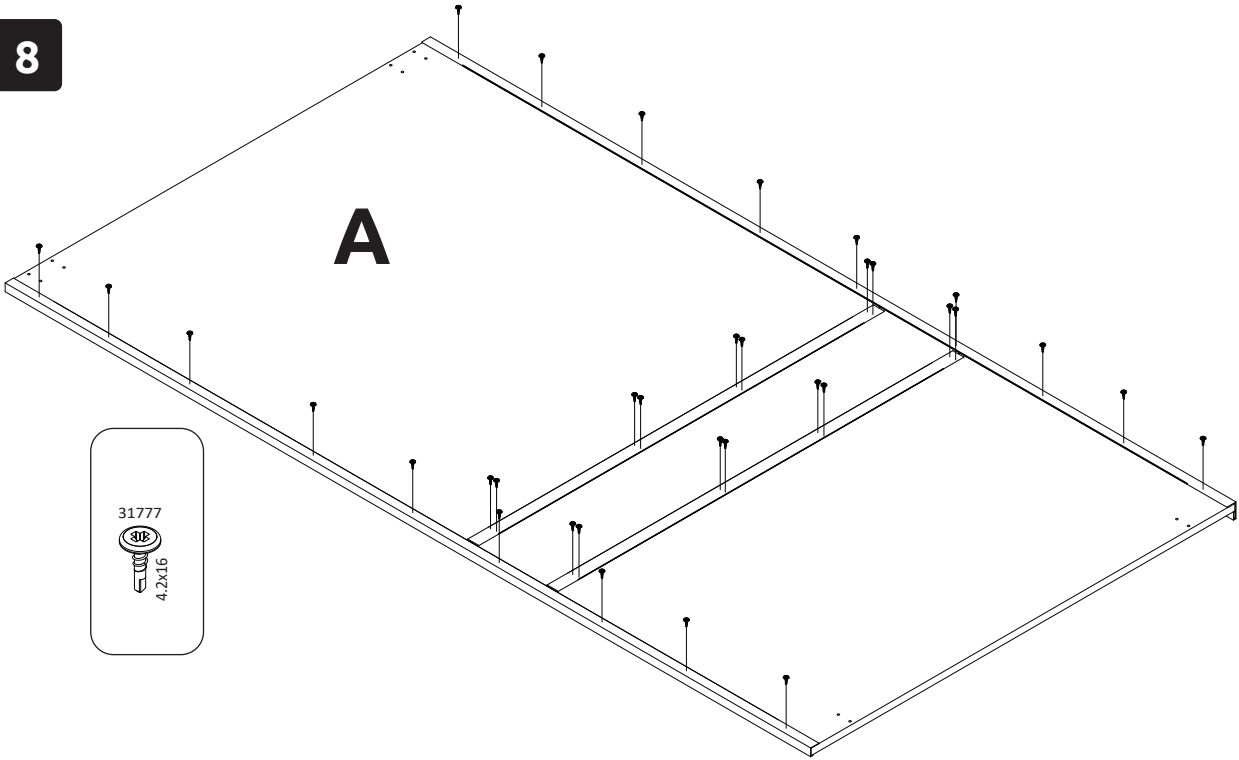

9

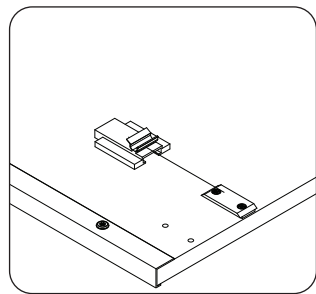
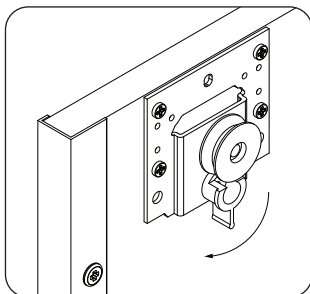
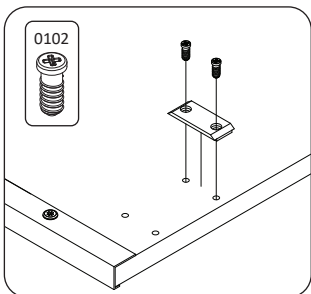
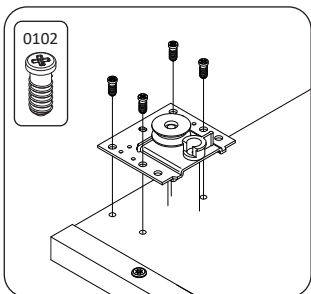
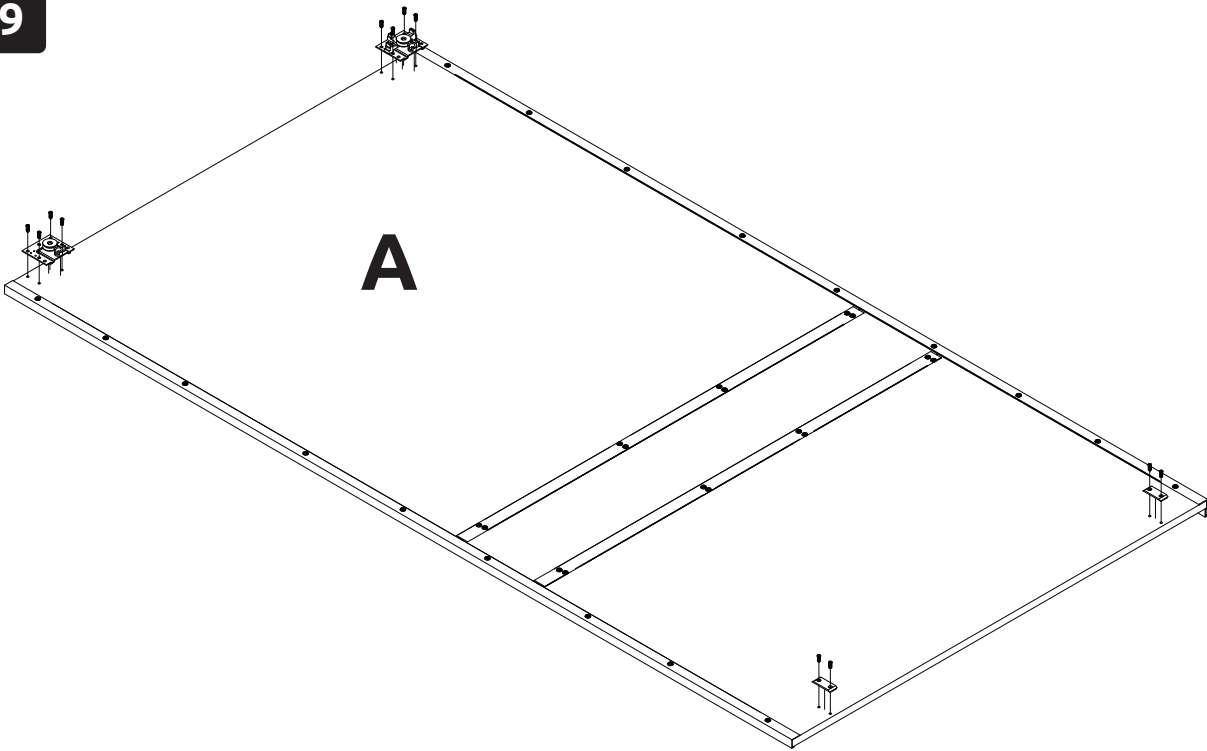

10

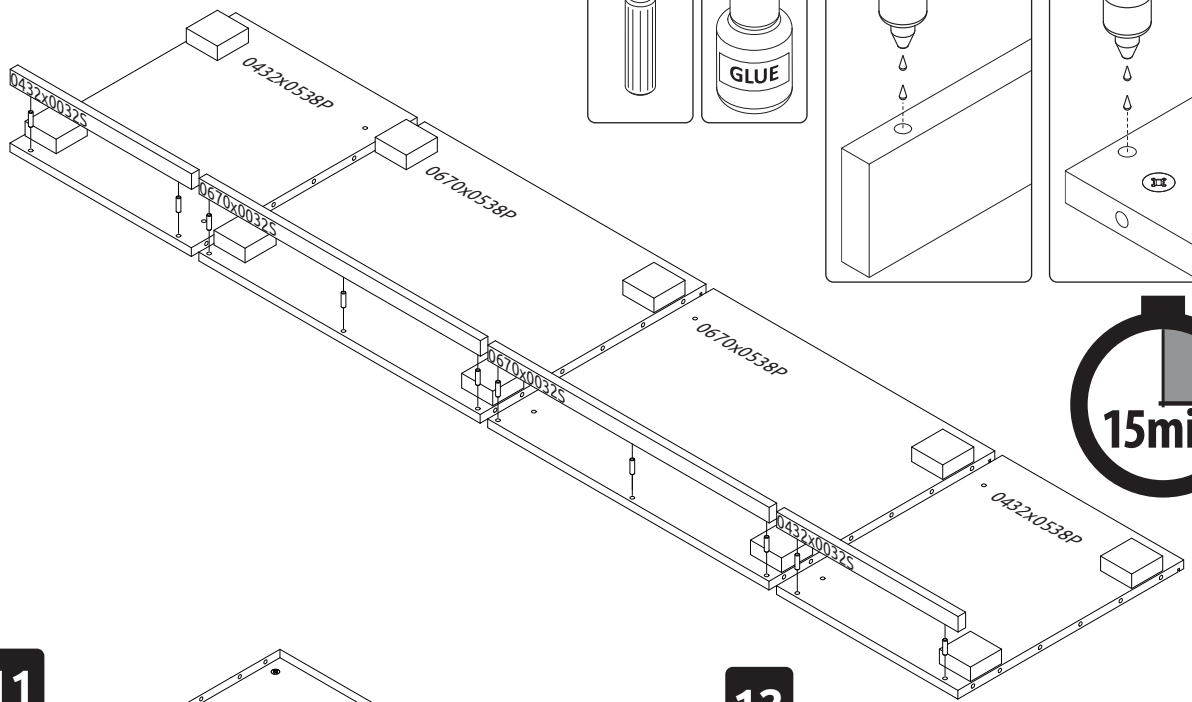

11

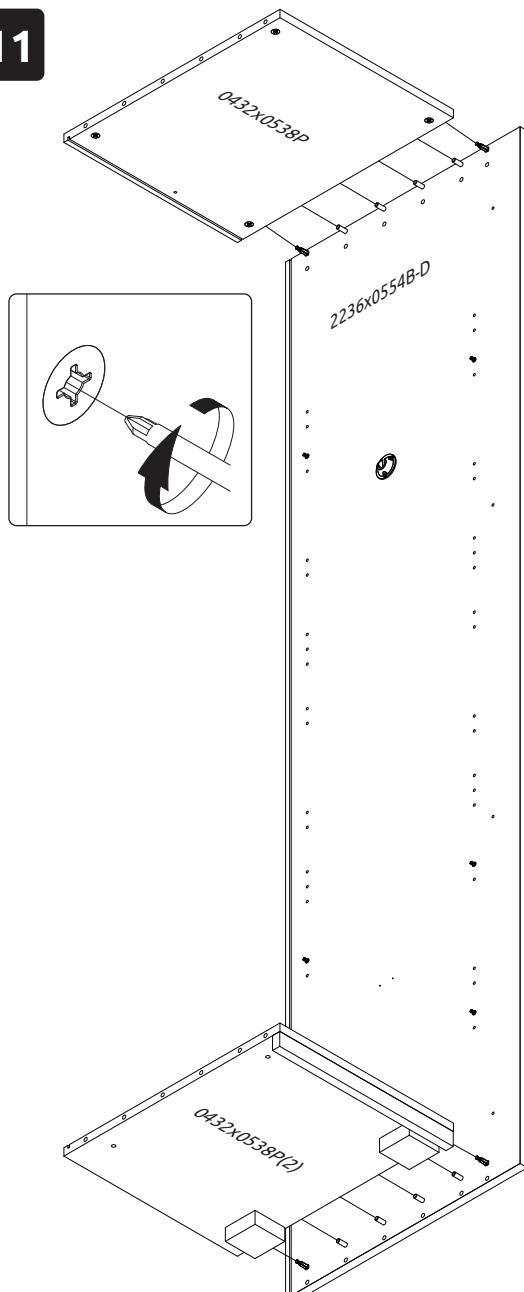

12

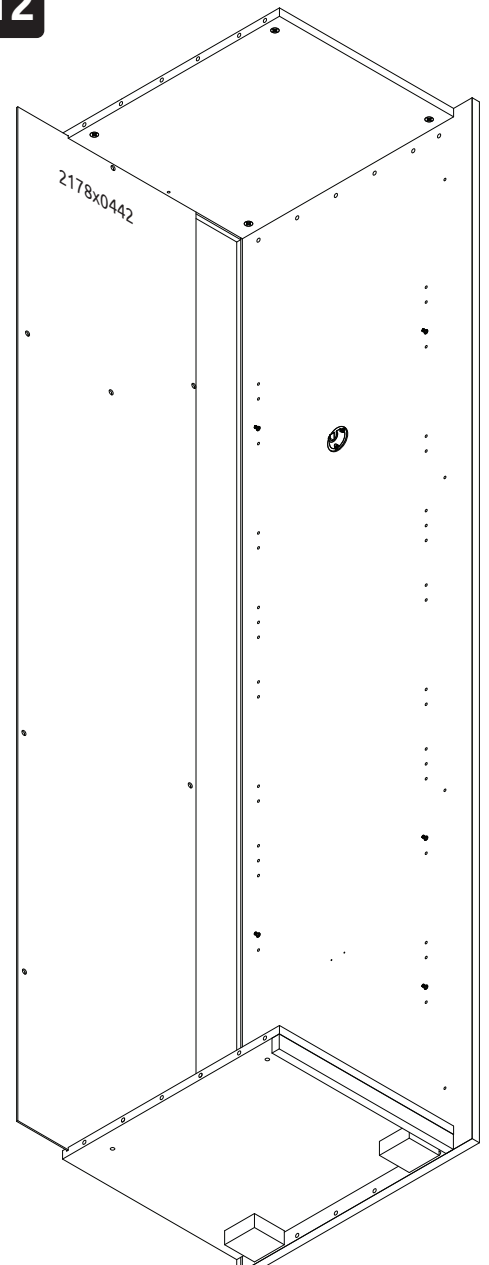

13

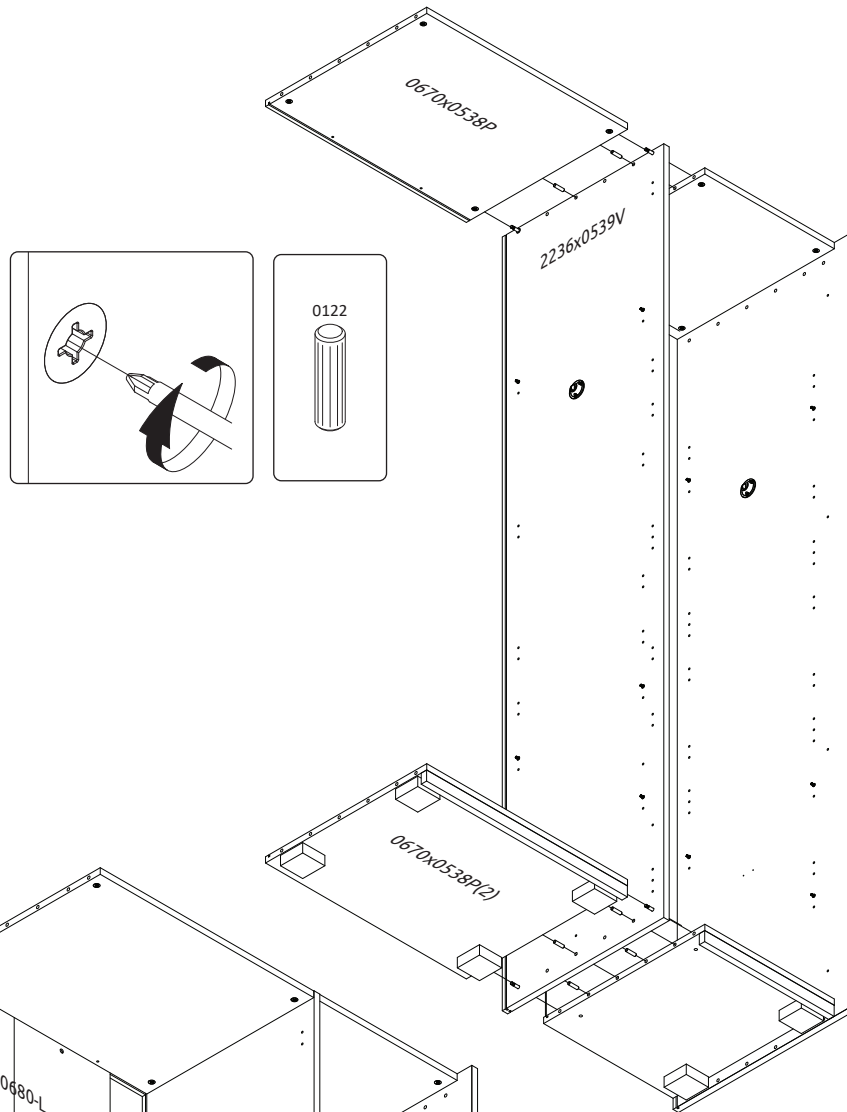

14

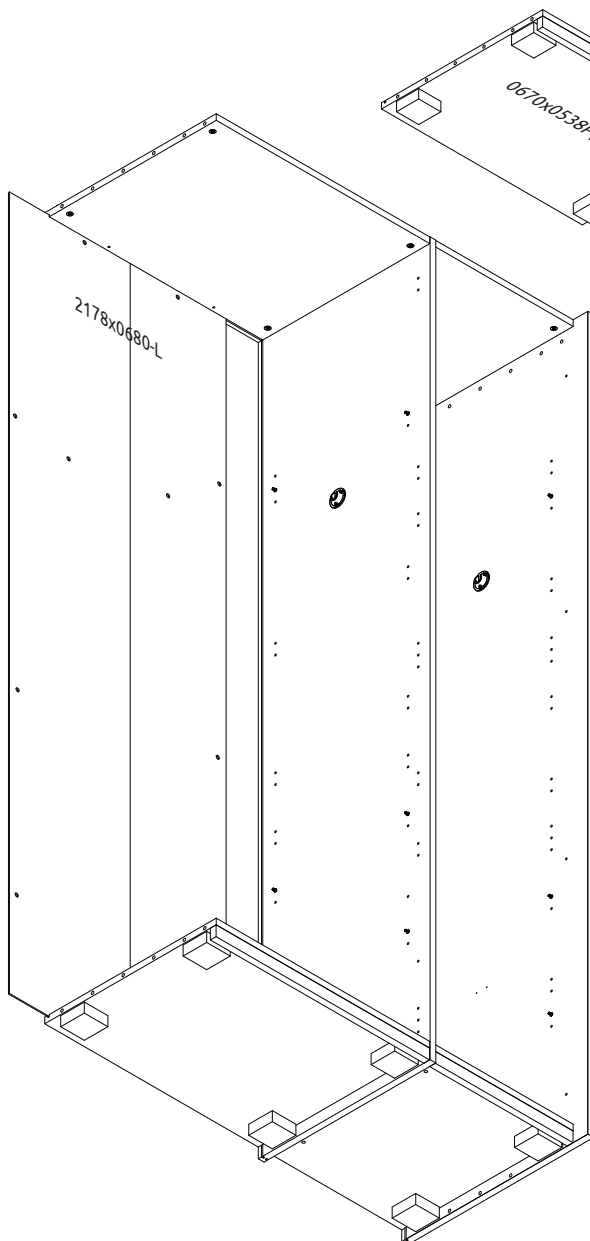

15

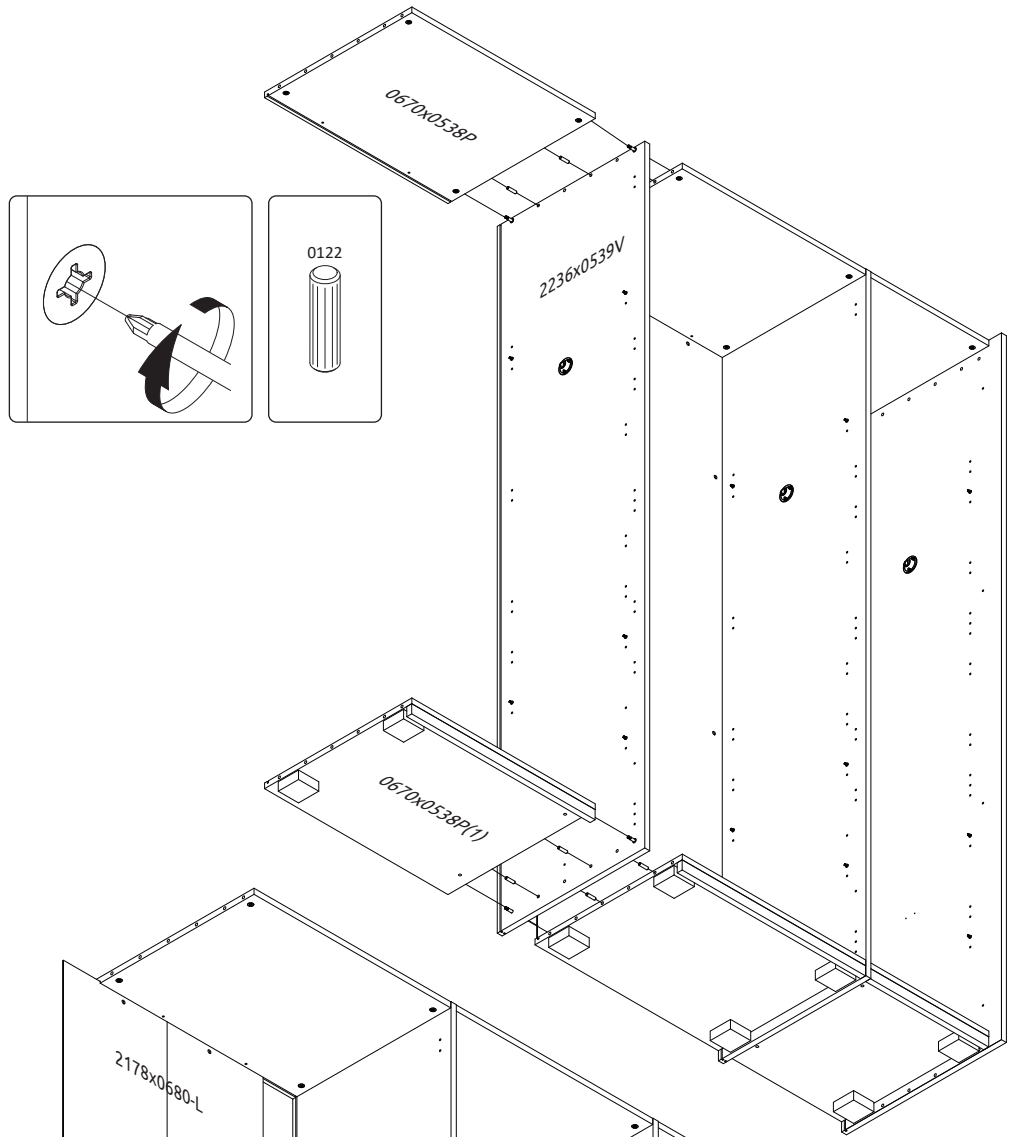

16

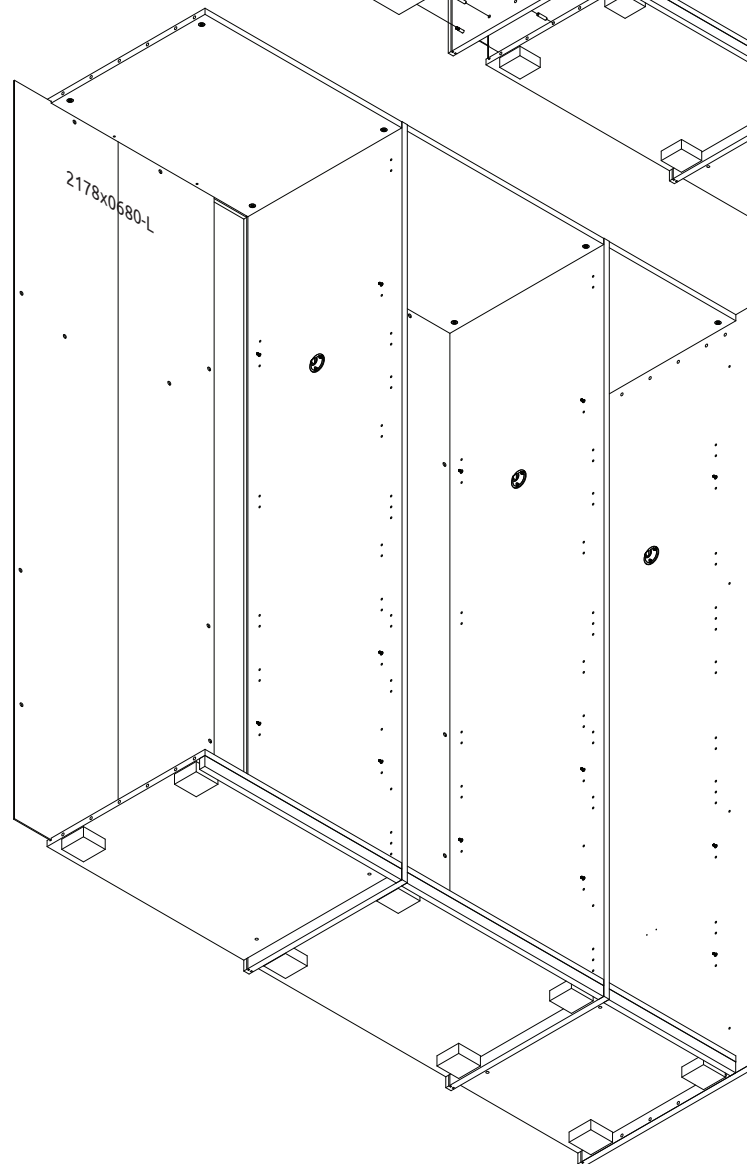

17

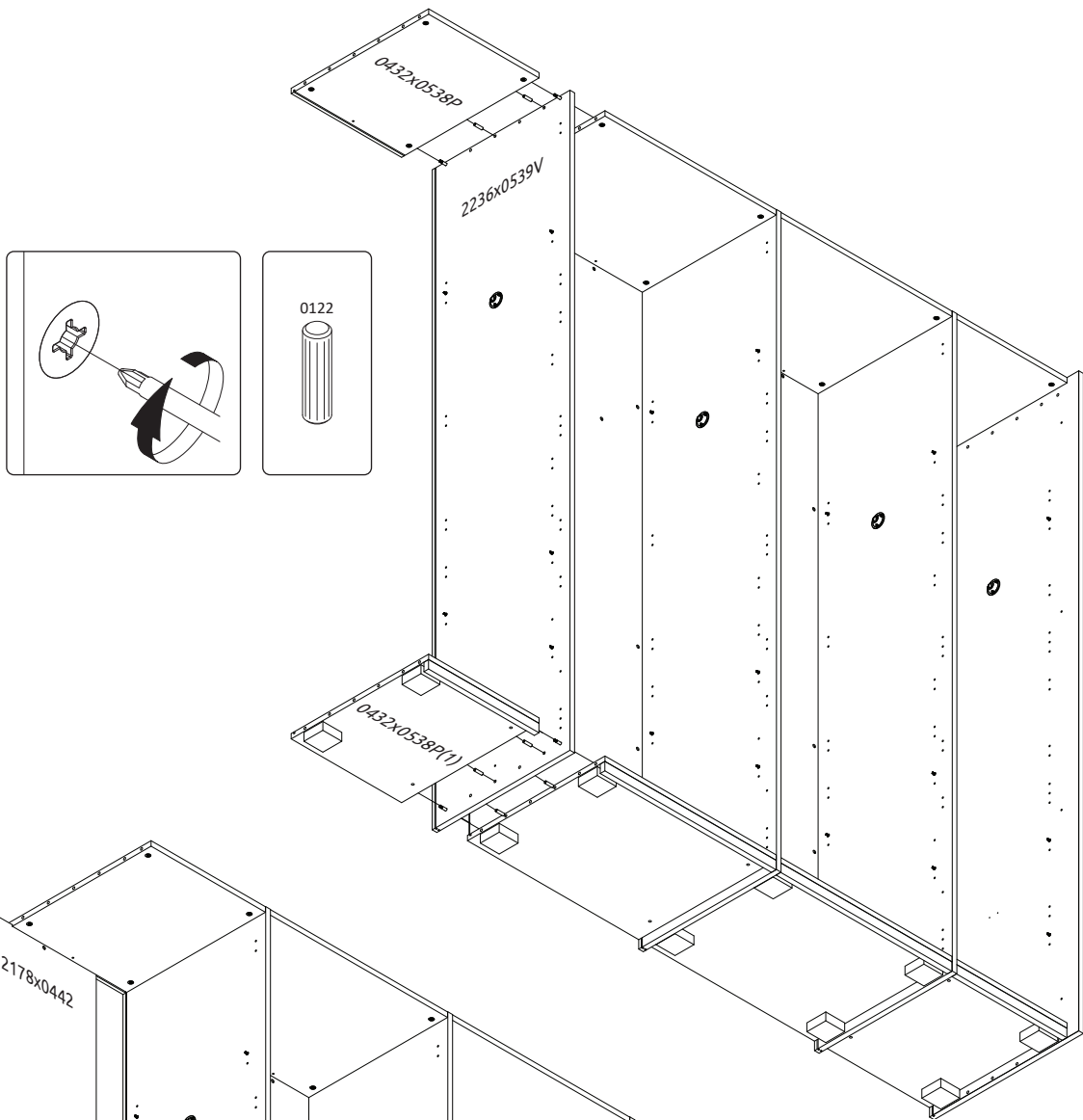

18

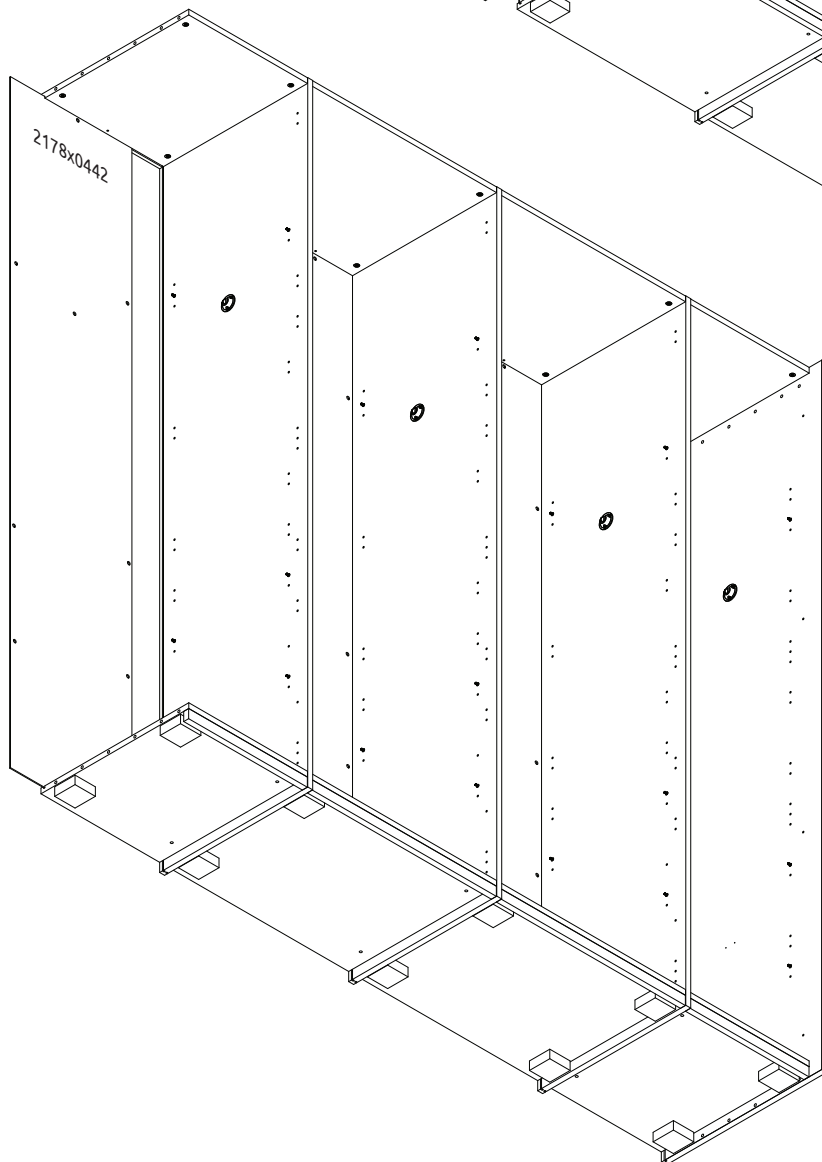

19

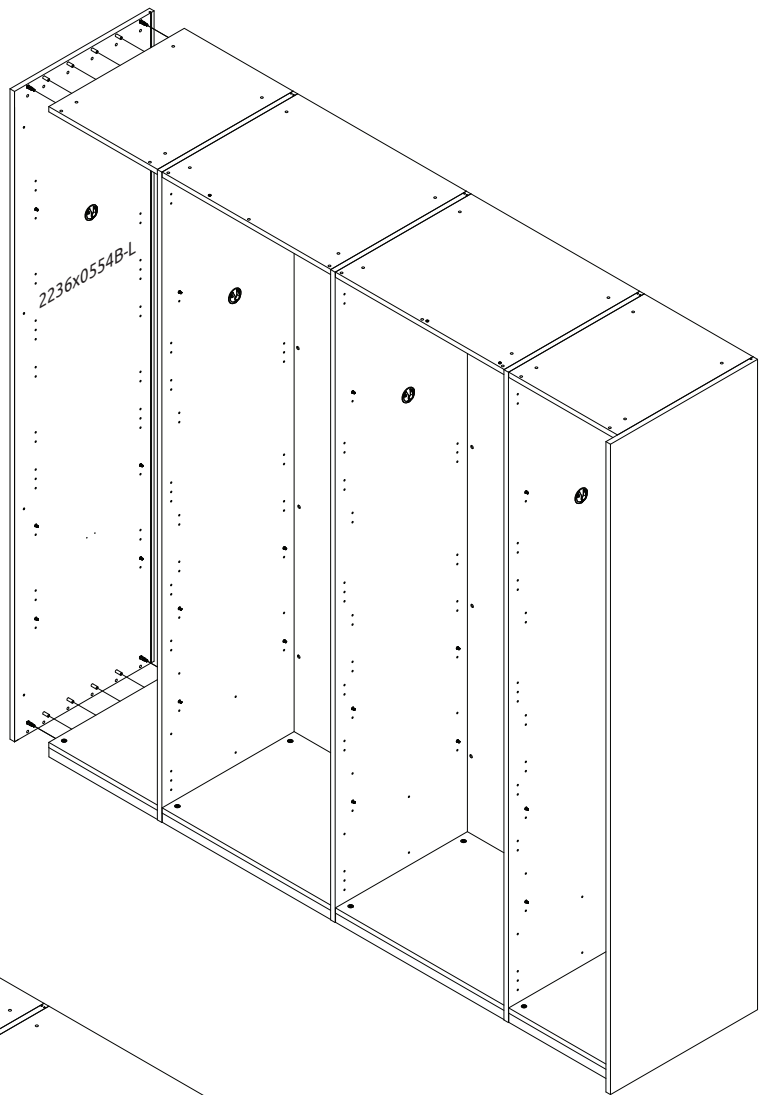
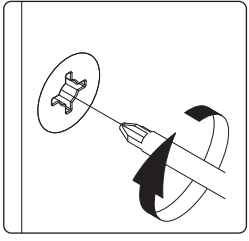

20

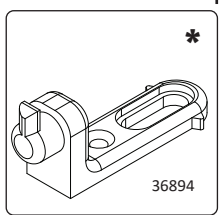
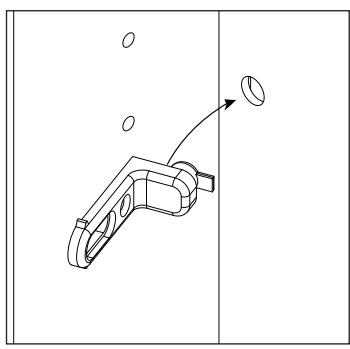
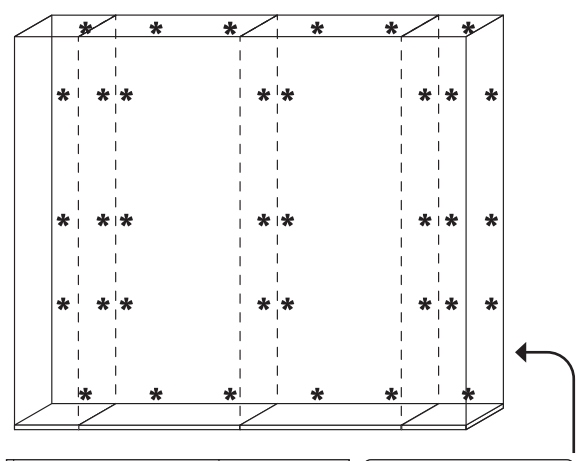
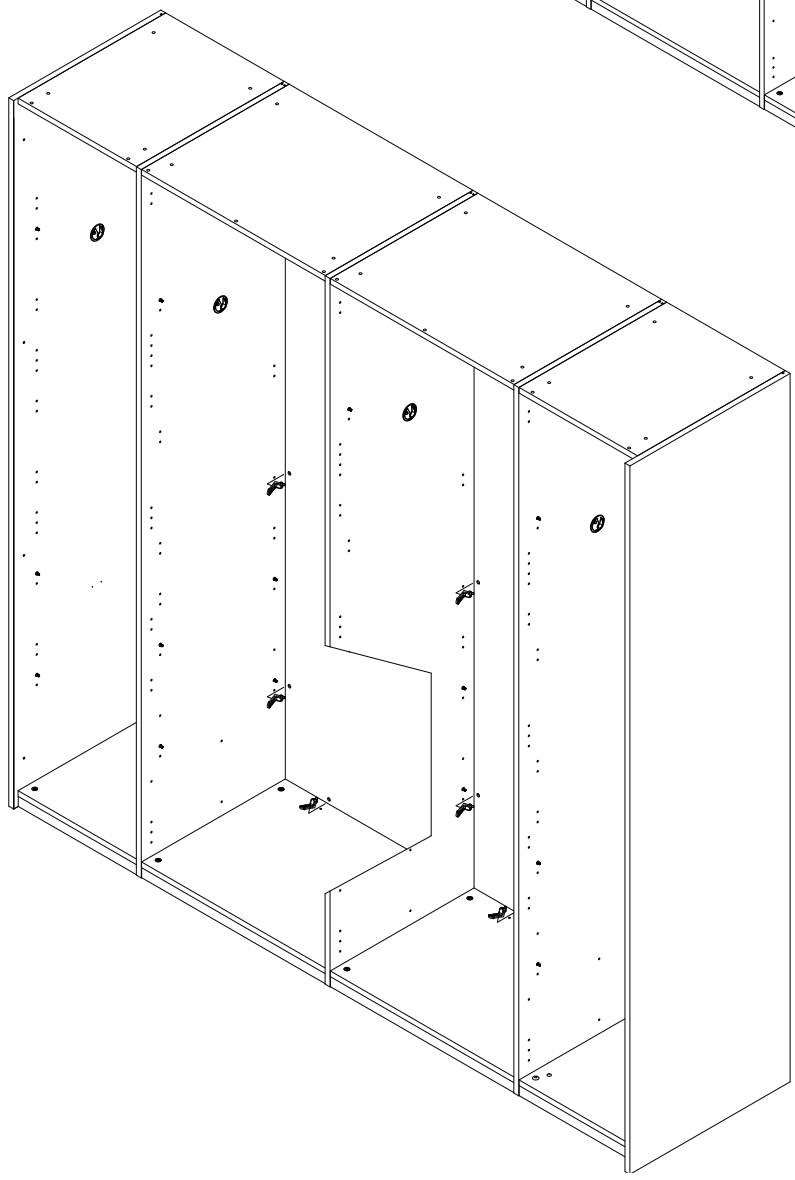

21

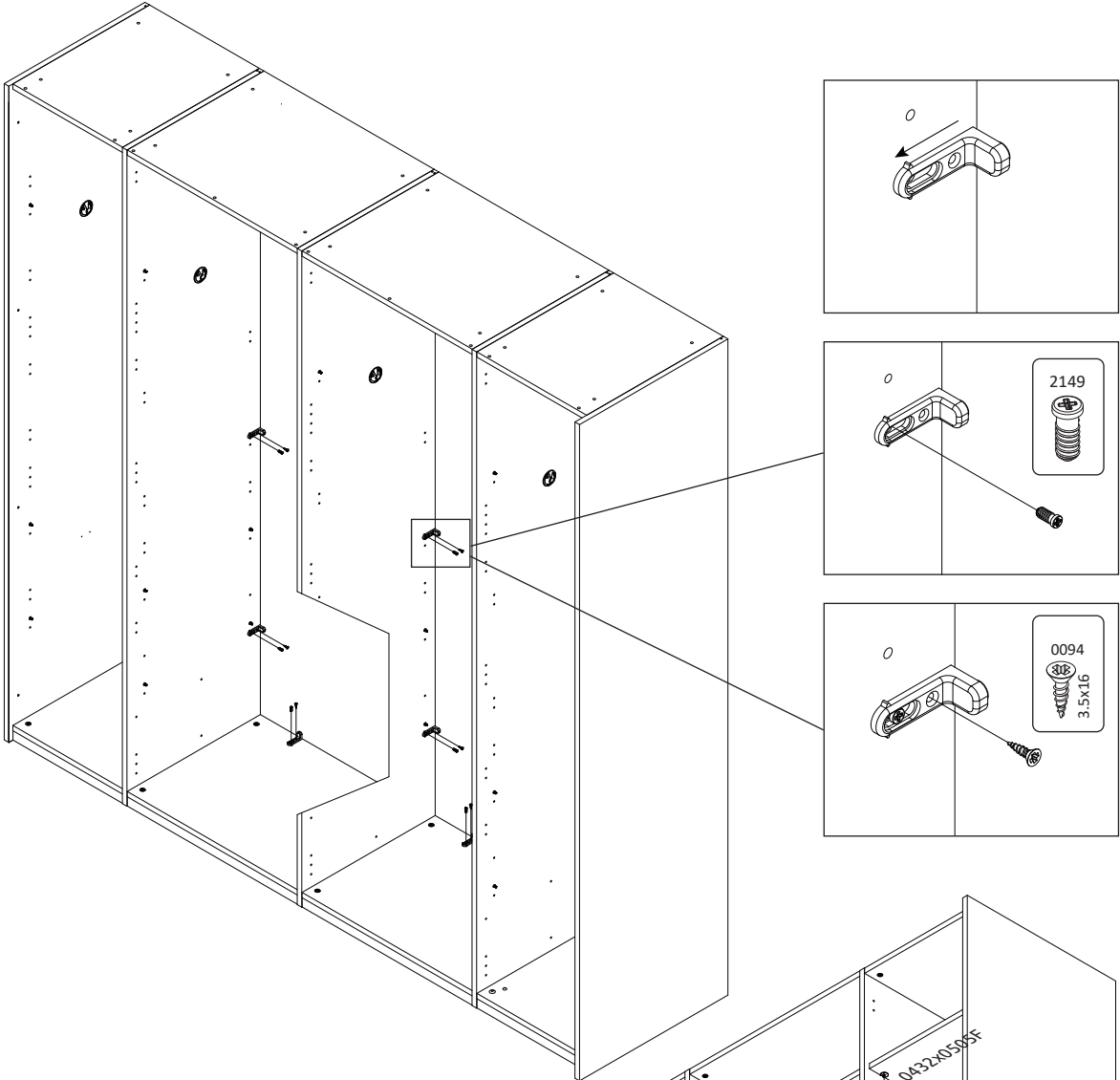

22

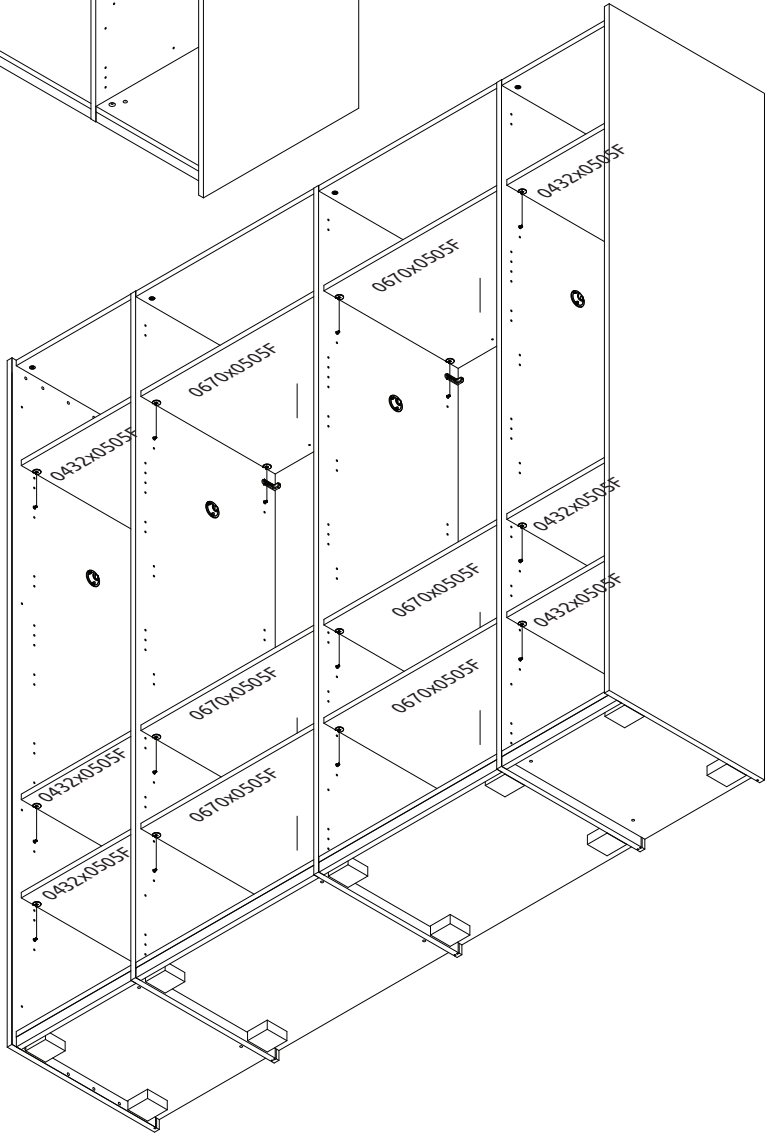

23

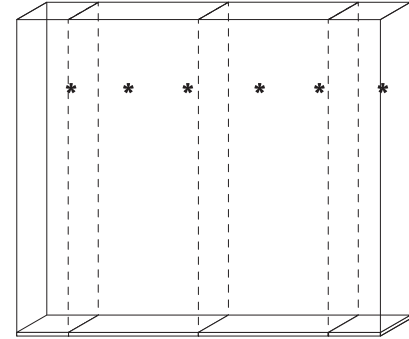
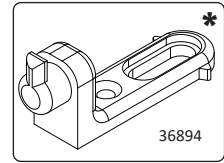
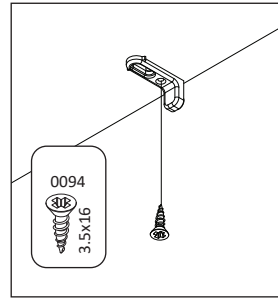
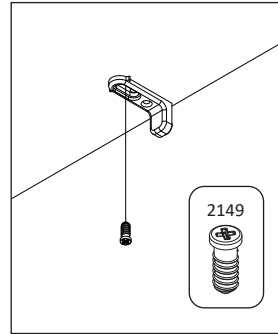
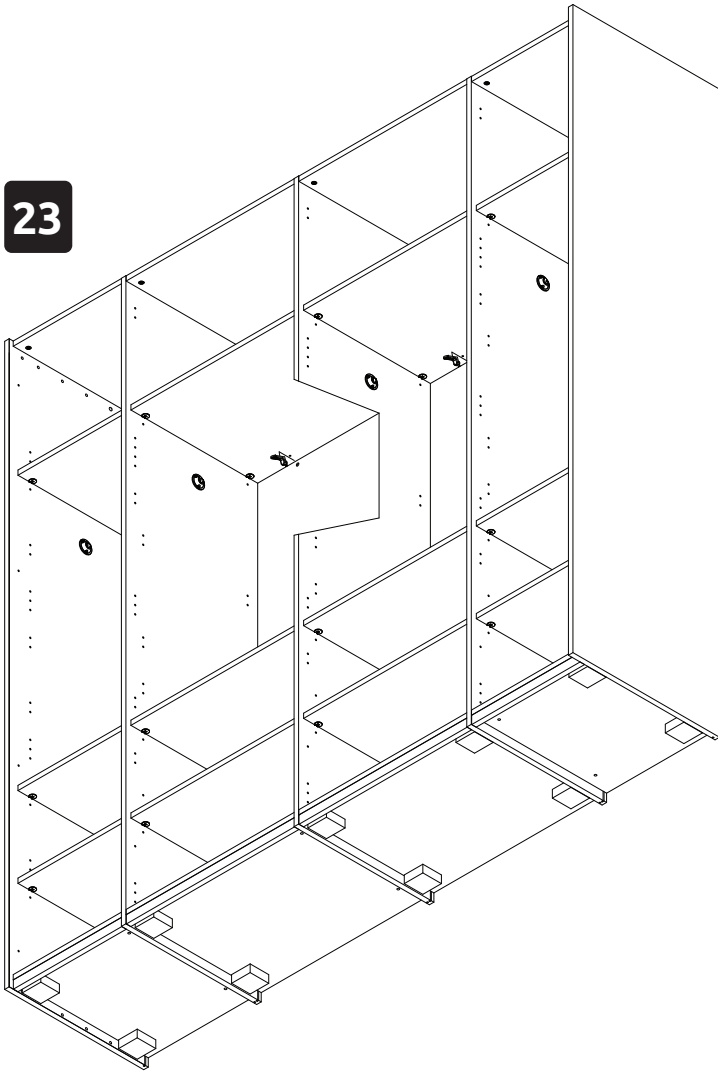

24

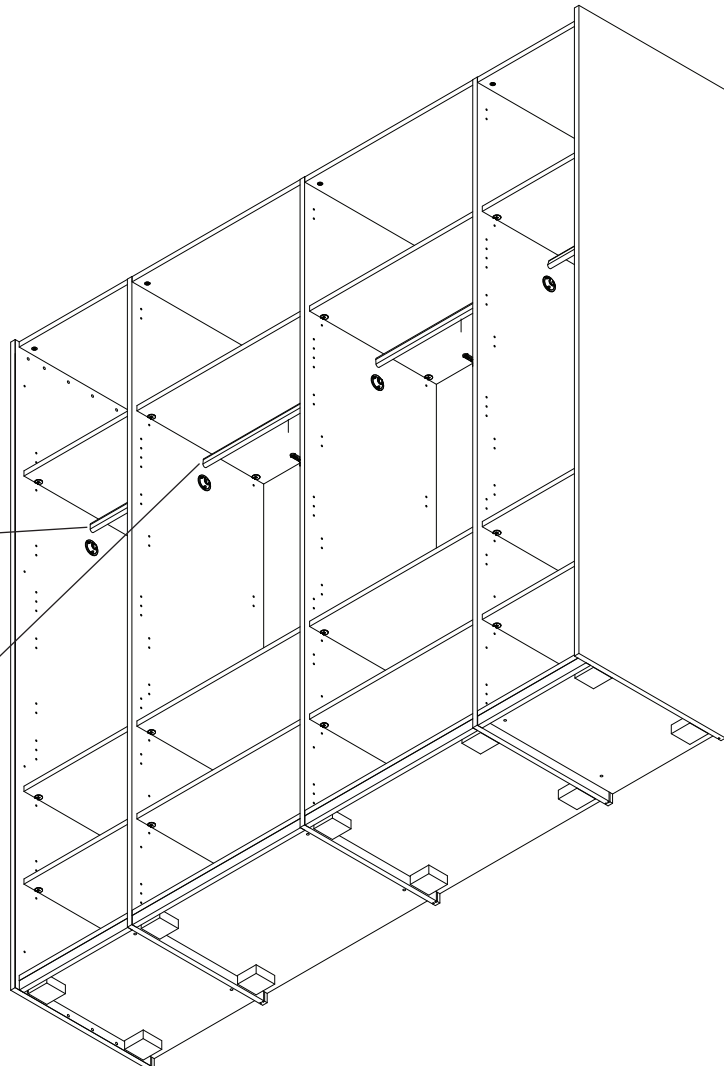
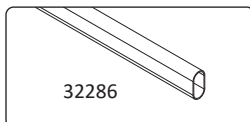
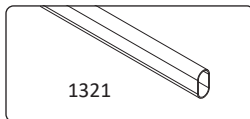

25

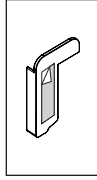
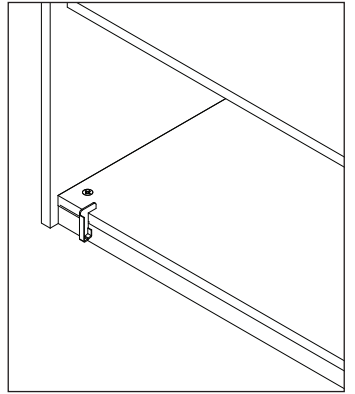
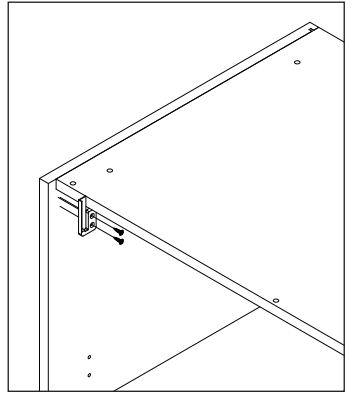
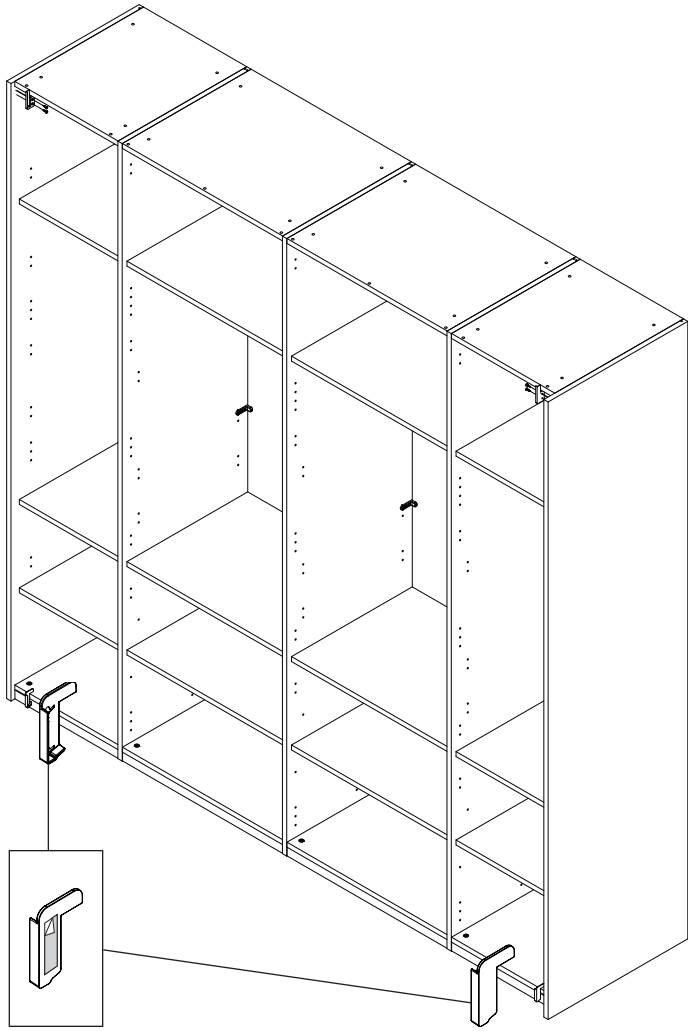
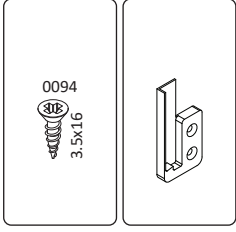

26

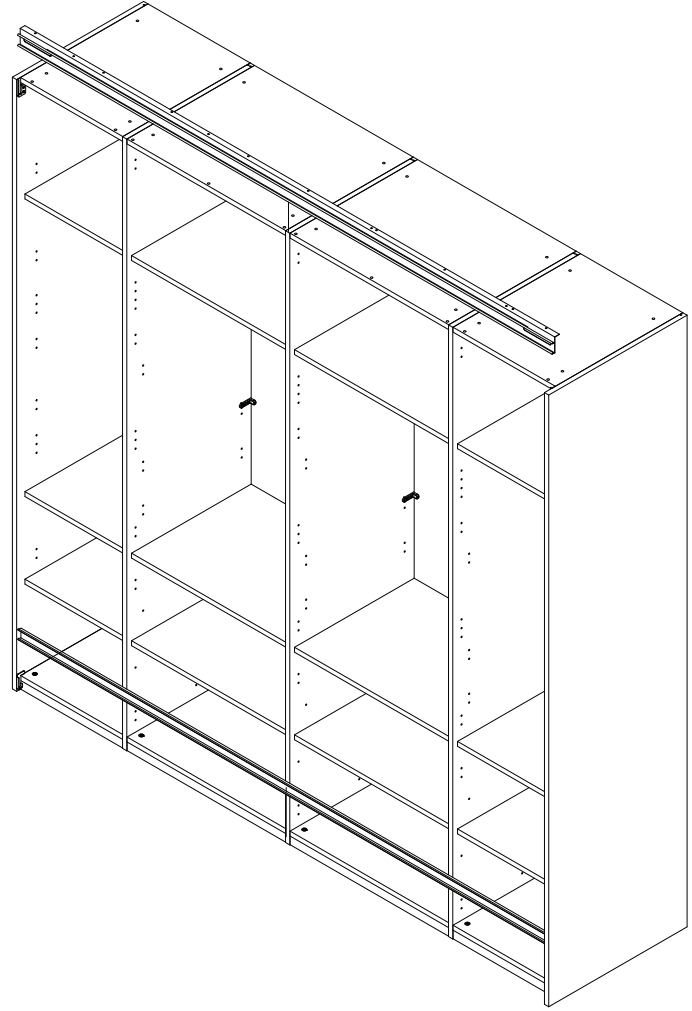
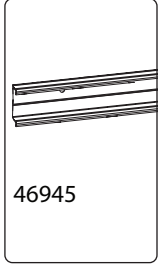
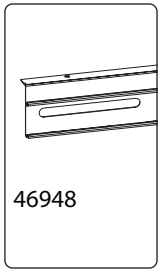

27

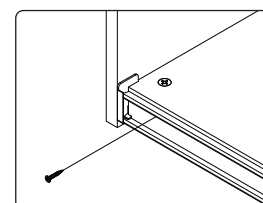
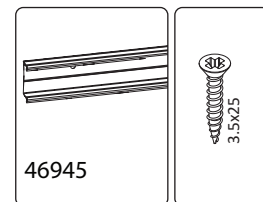
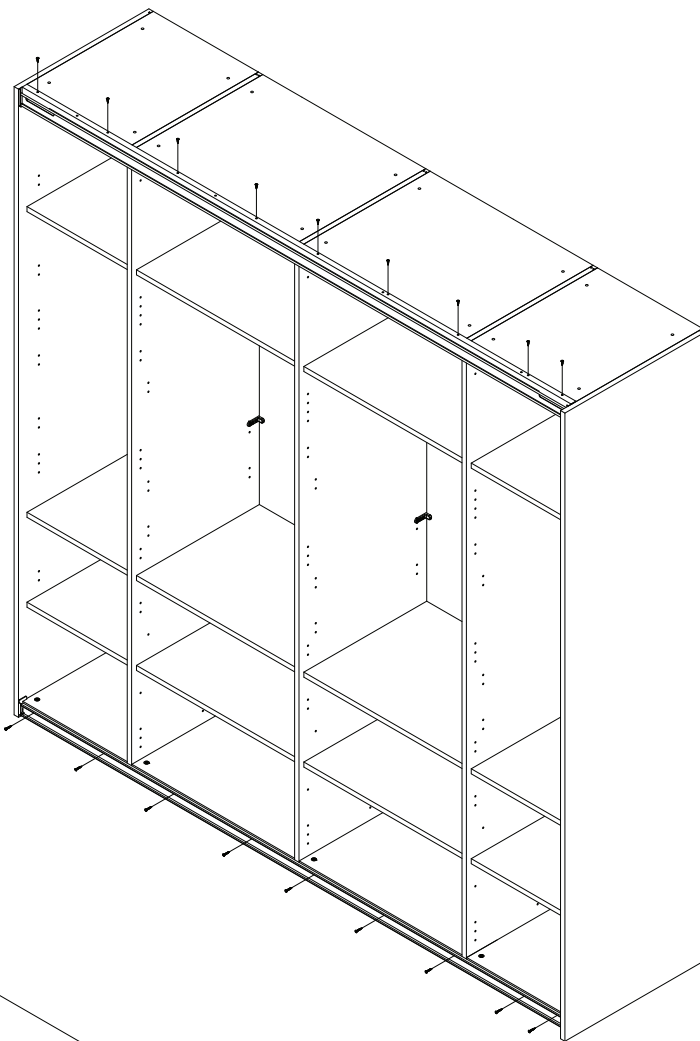
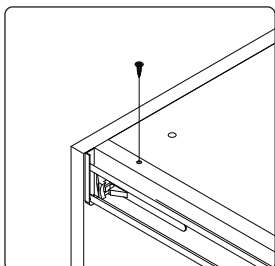
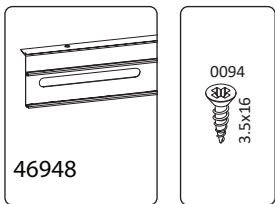

28

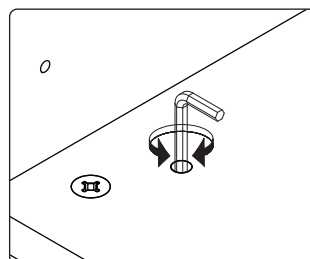
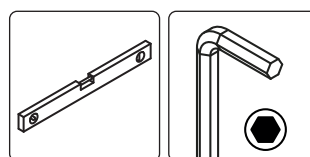
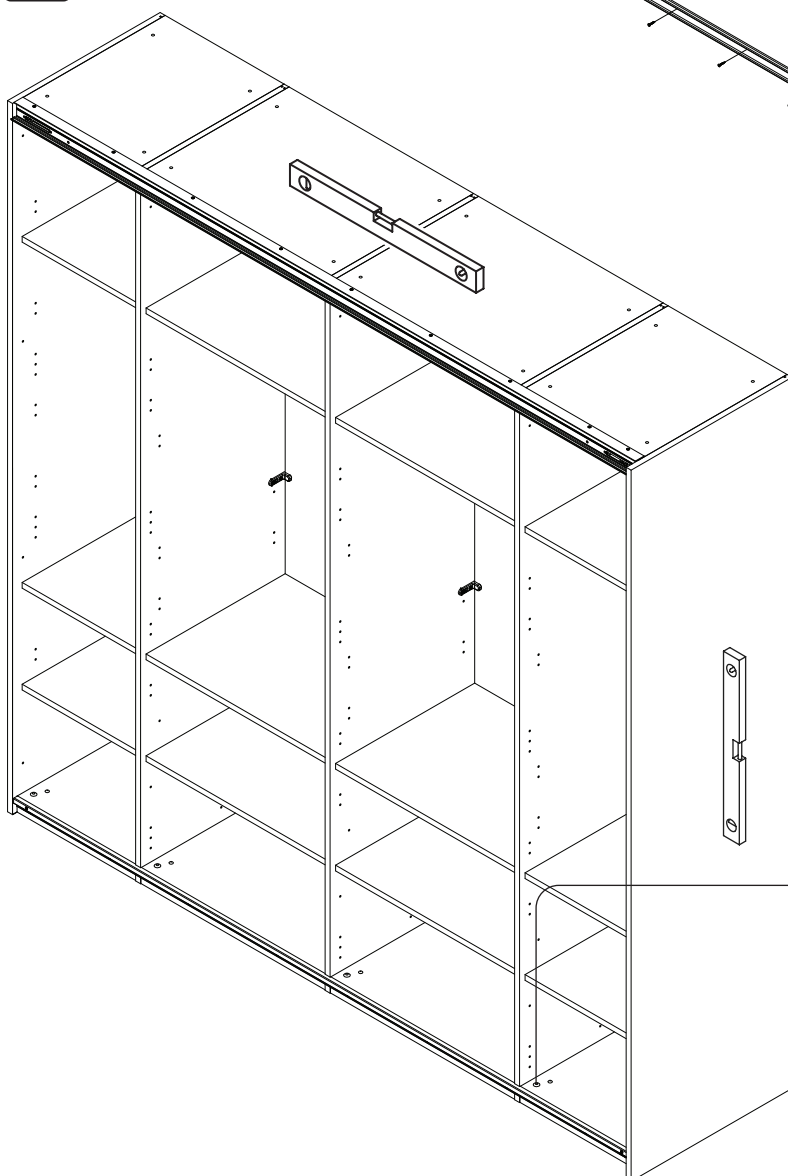

29

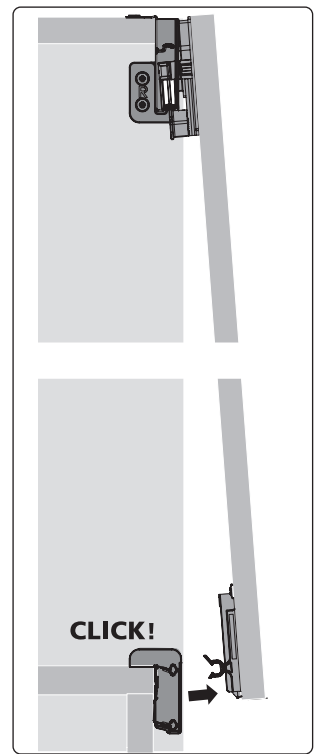
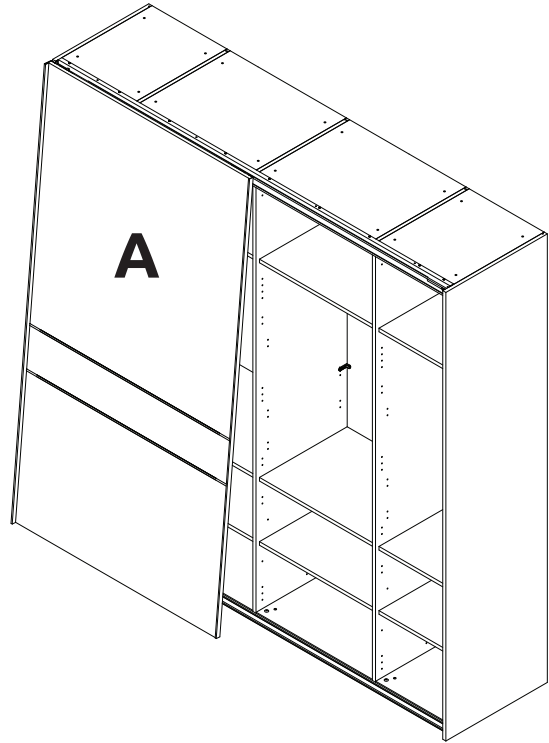
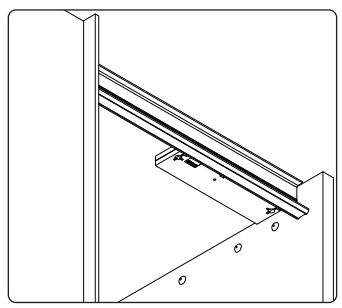
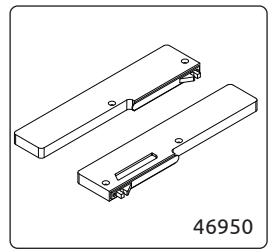
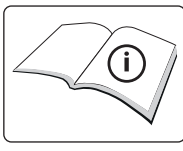

30

