

Model: **RANDOM**

**1/13**

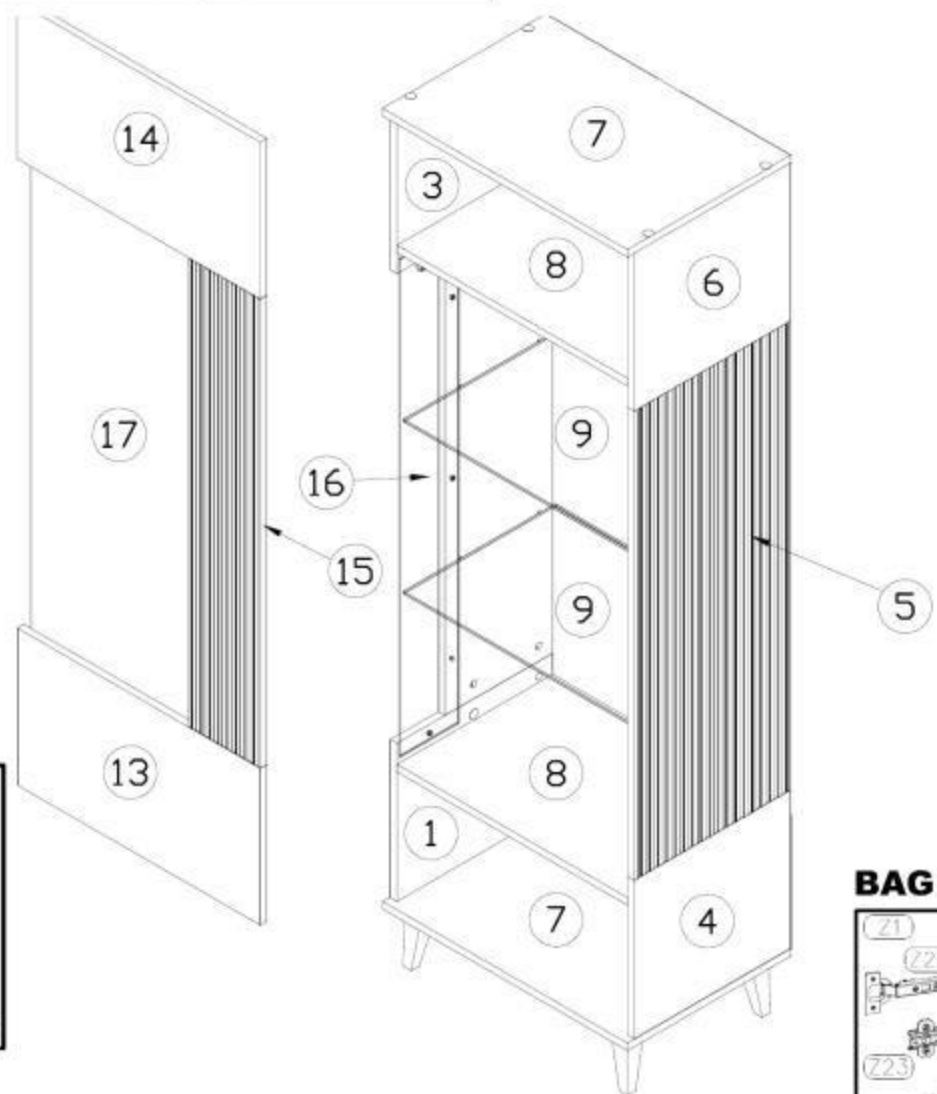

**BAG 2**

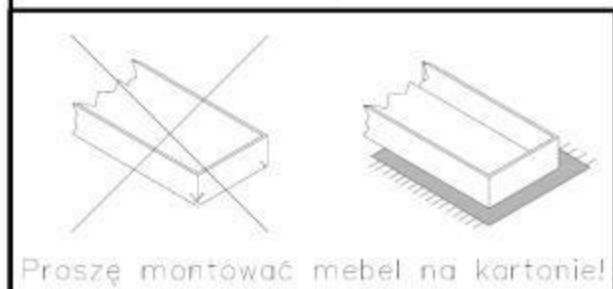
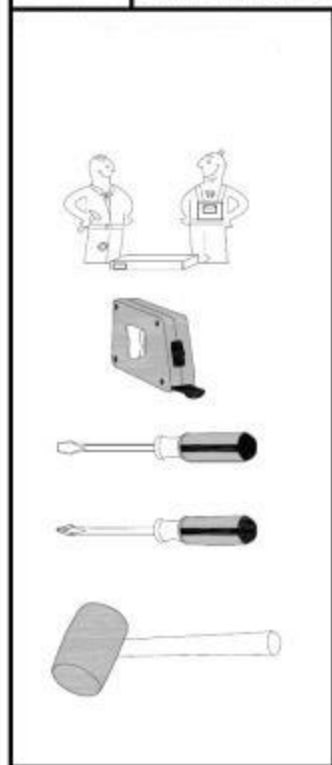
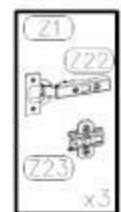

**BAG 3**



**BAG 4**



**BAG 1**

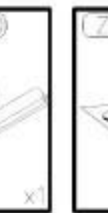
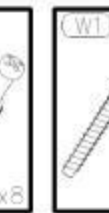
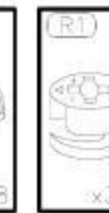
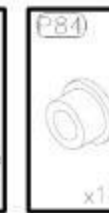

**1**

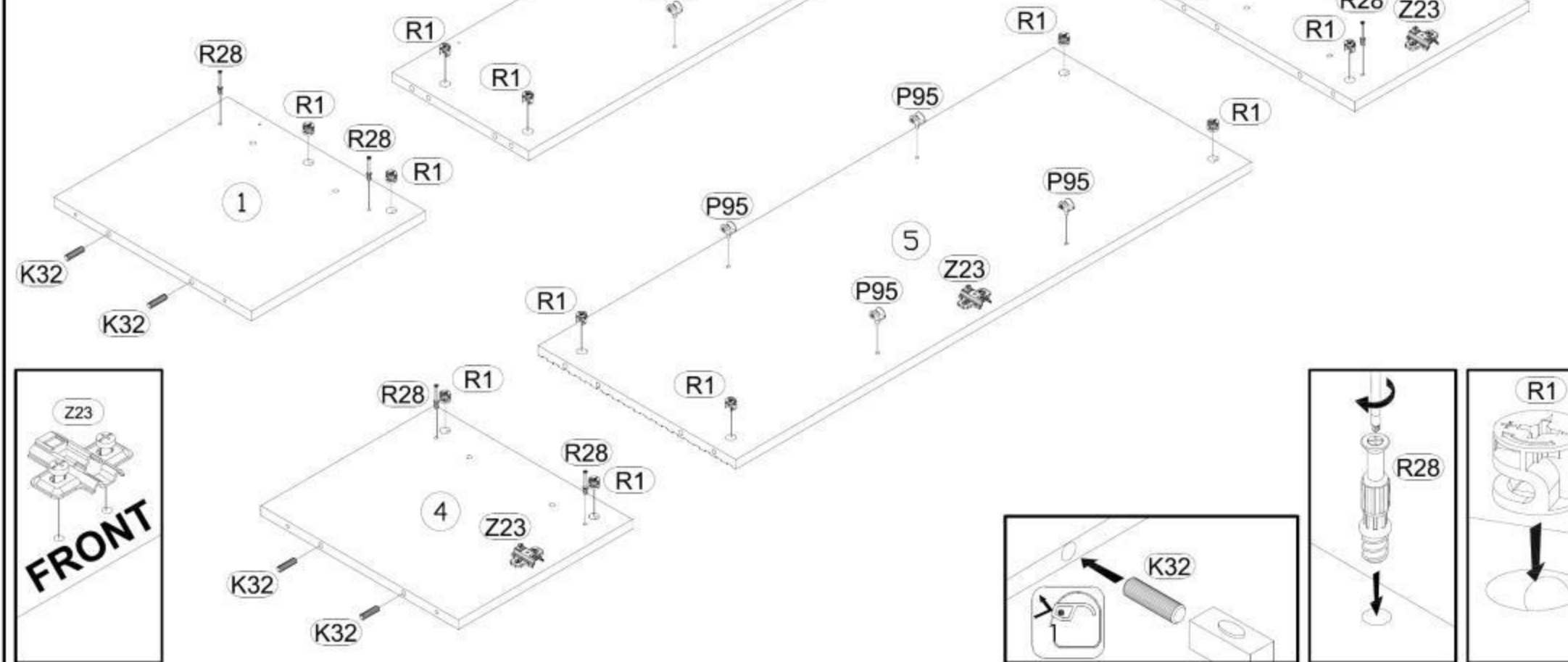
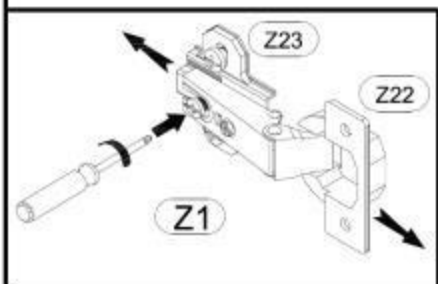

# 2

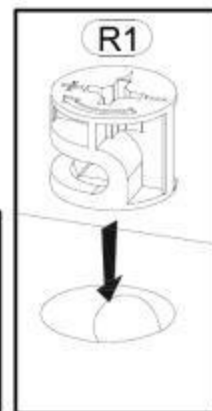
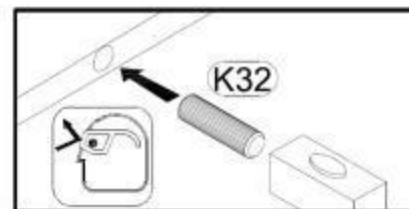
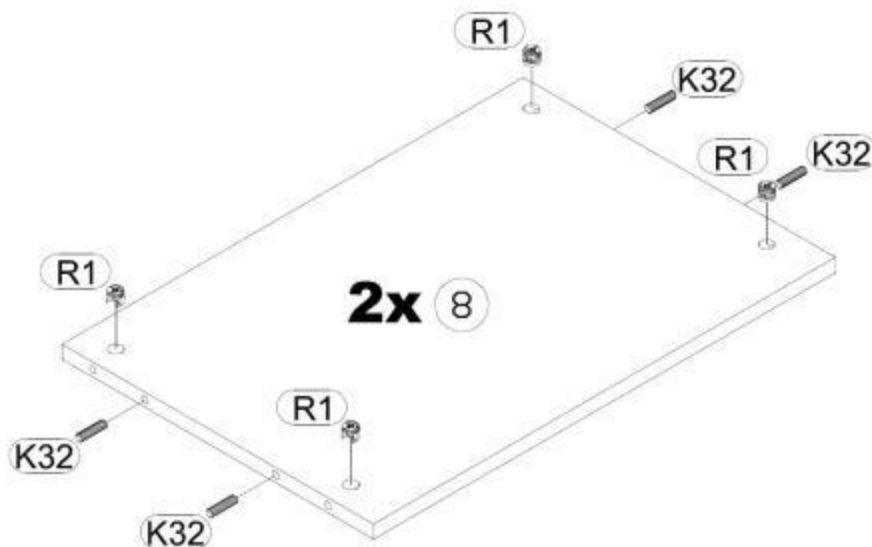
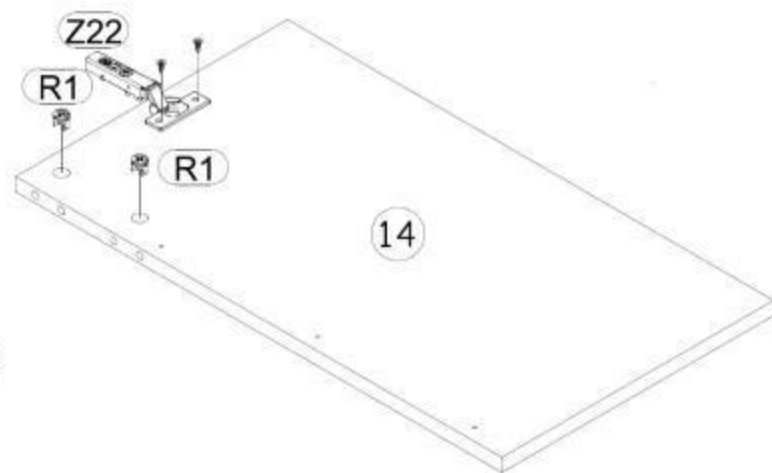
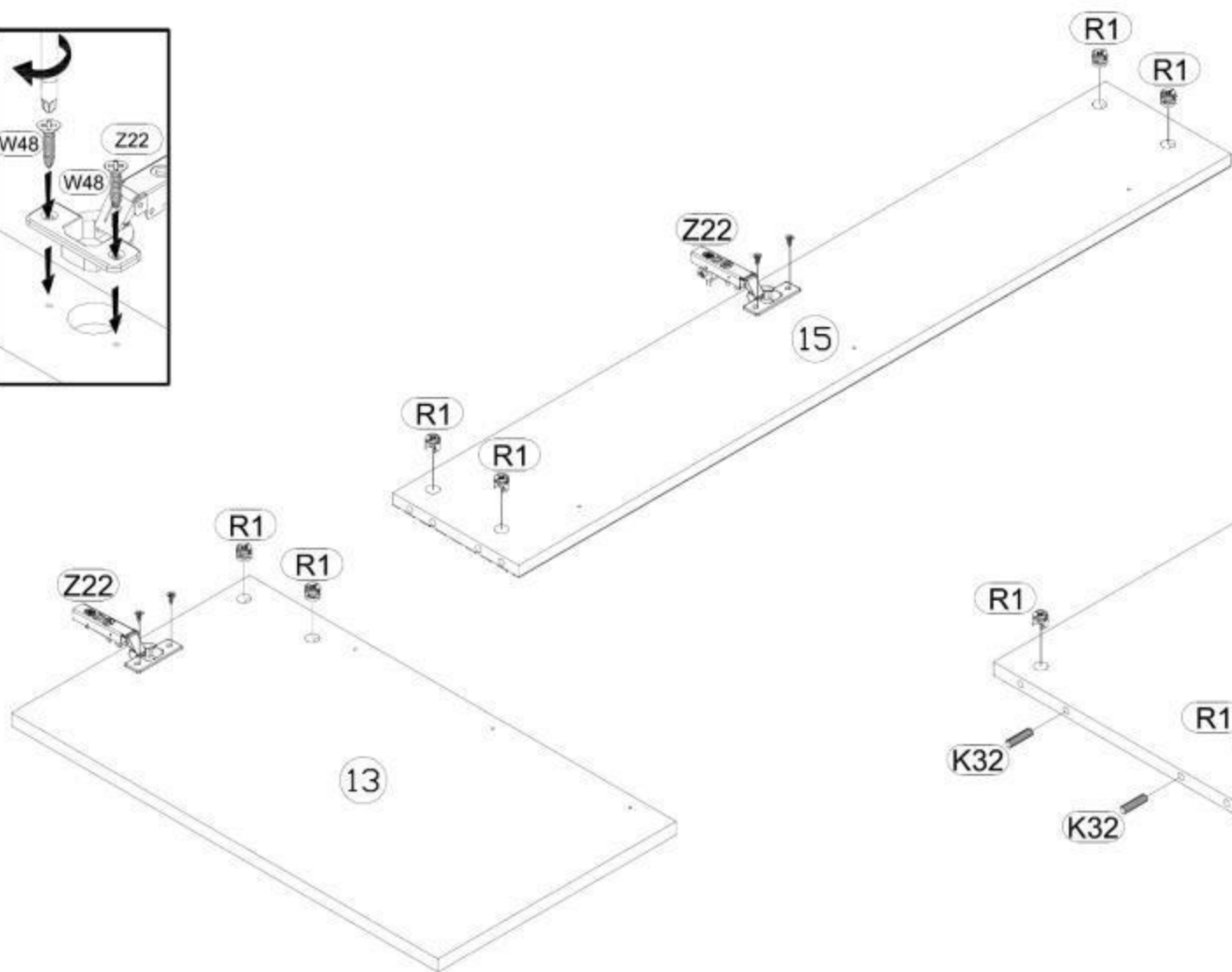
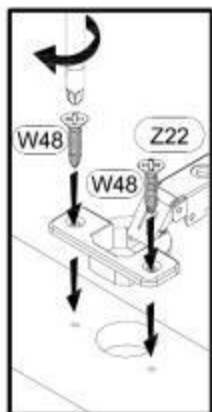

**3**

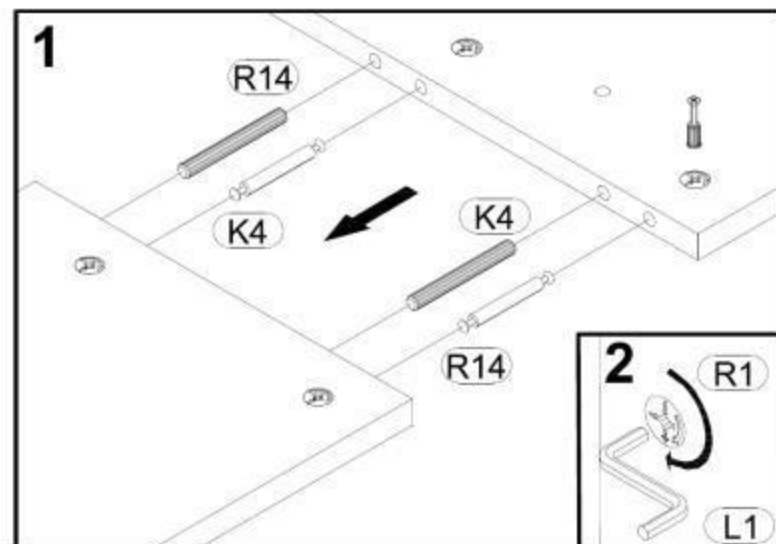
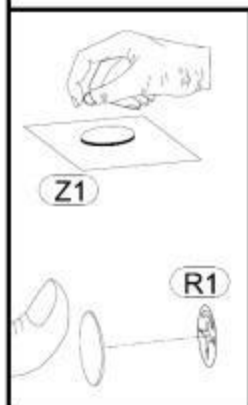
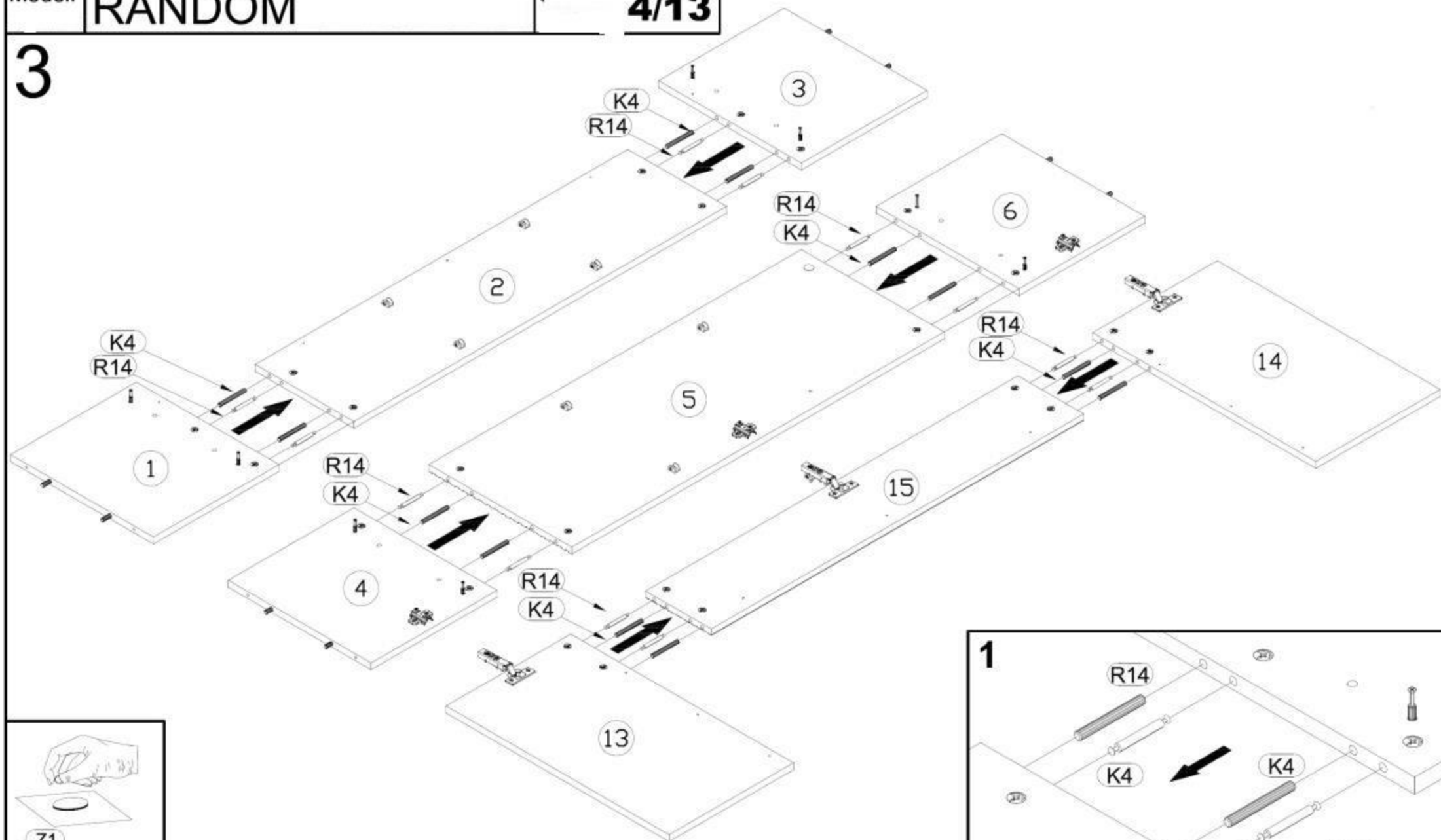

# 4

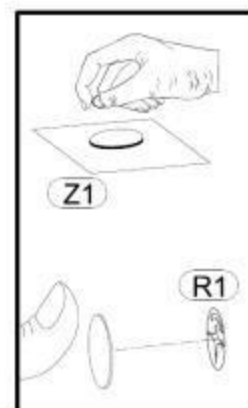
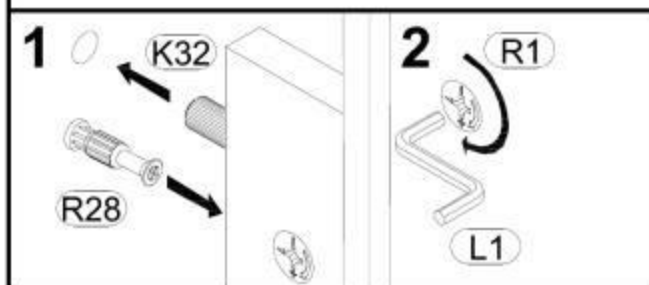
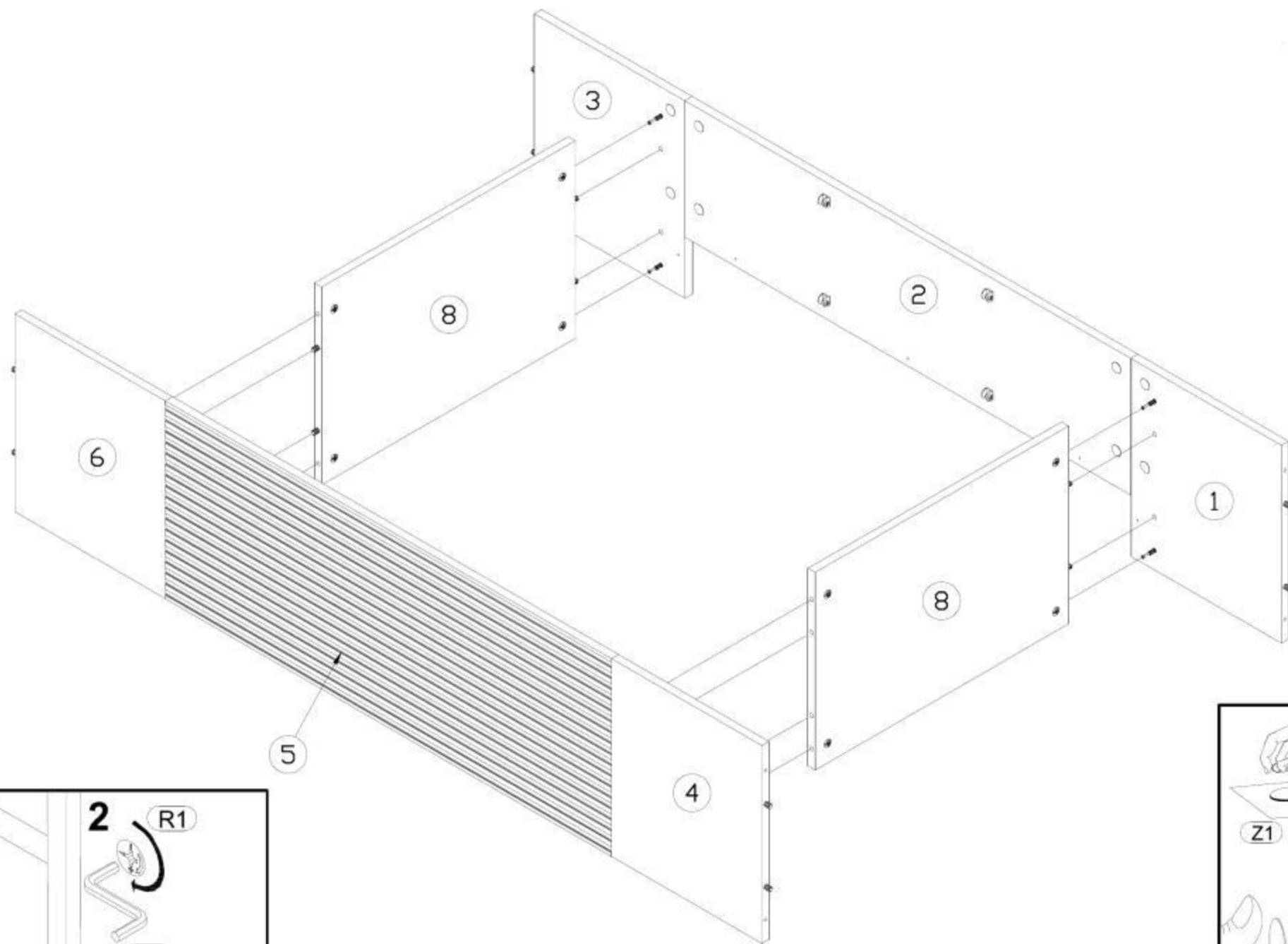

**5**

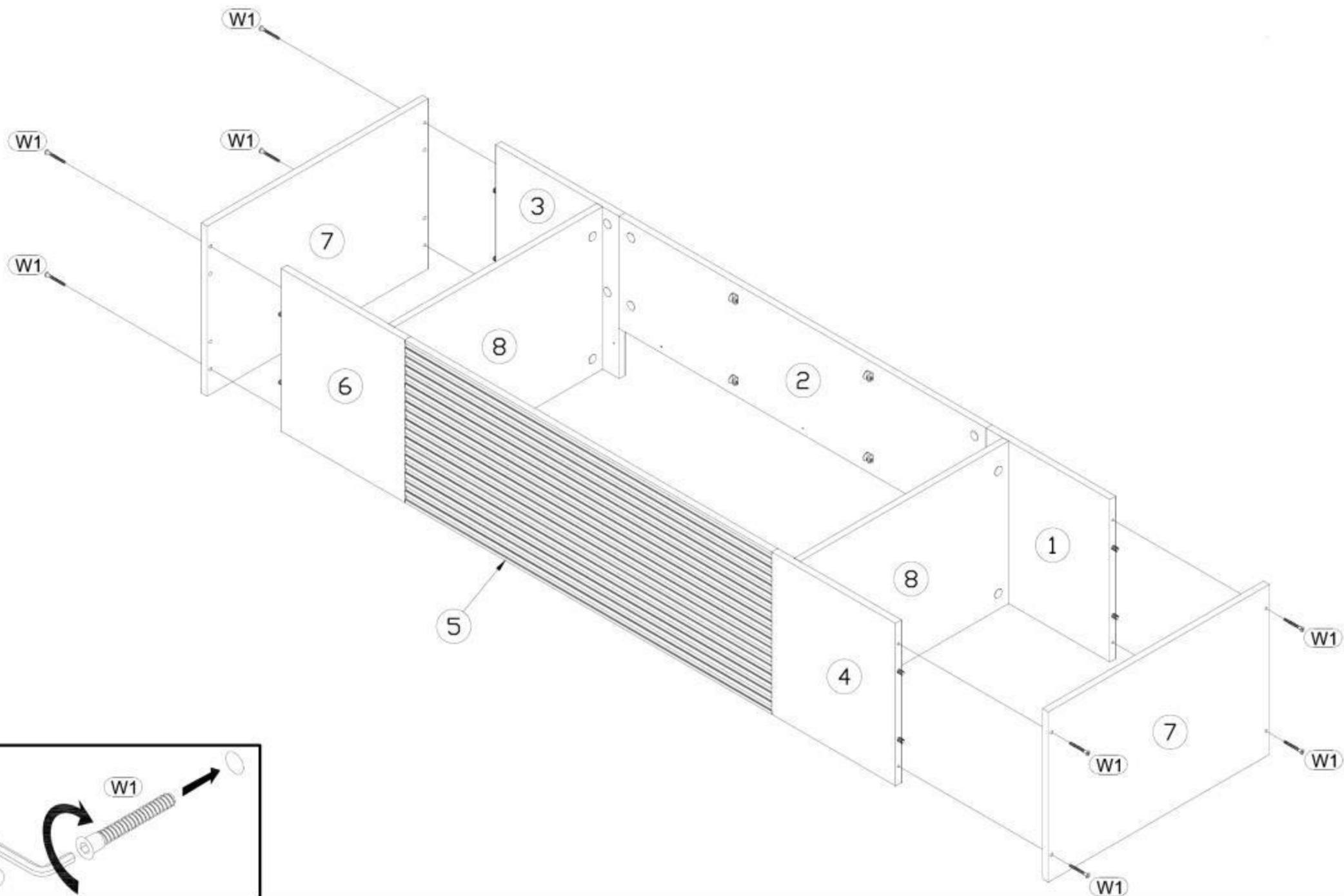

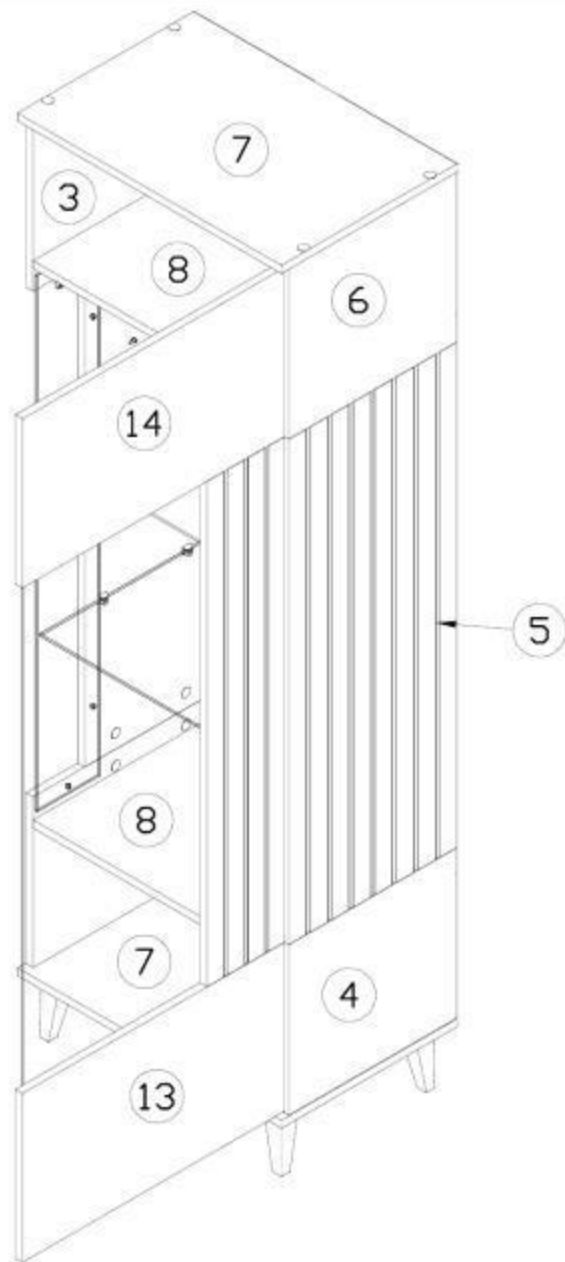

**"RIGHT" 6-9**

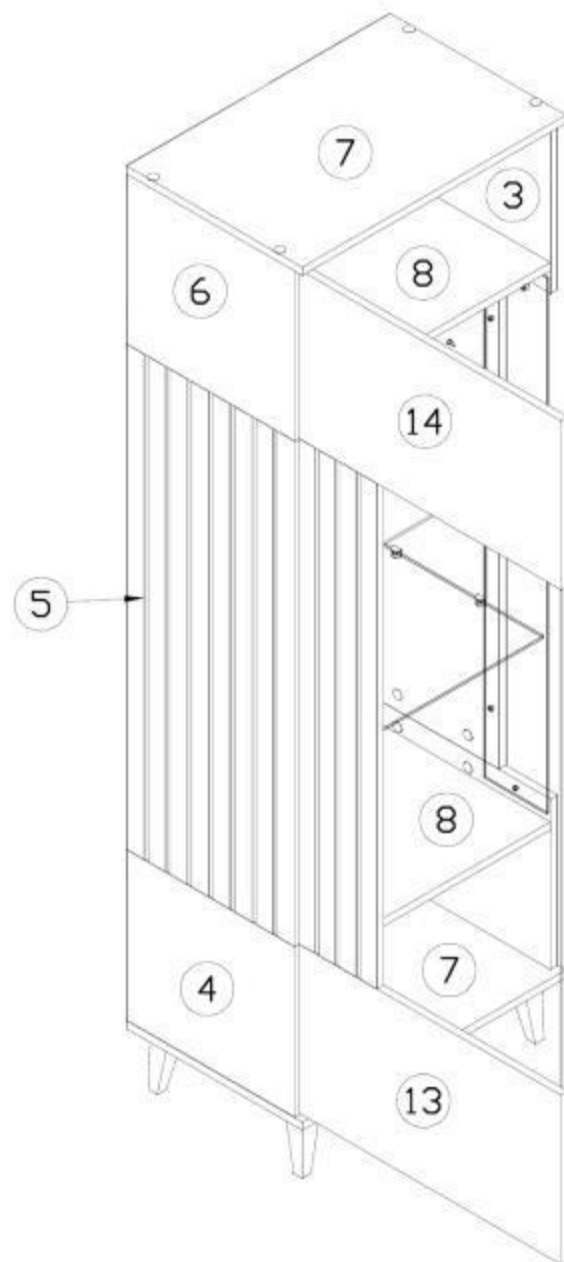

**"LEFT" 10-13**

**6**

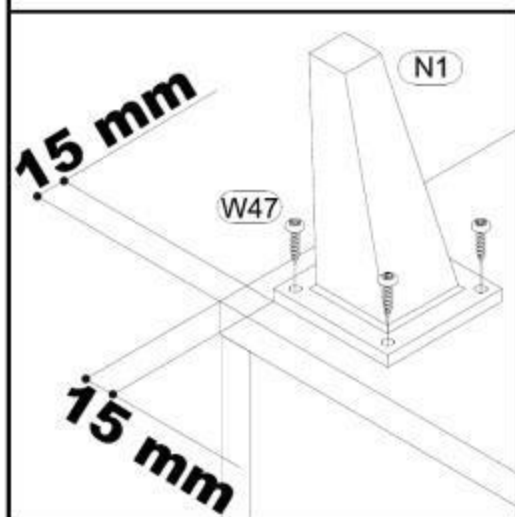
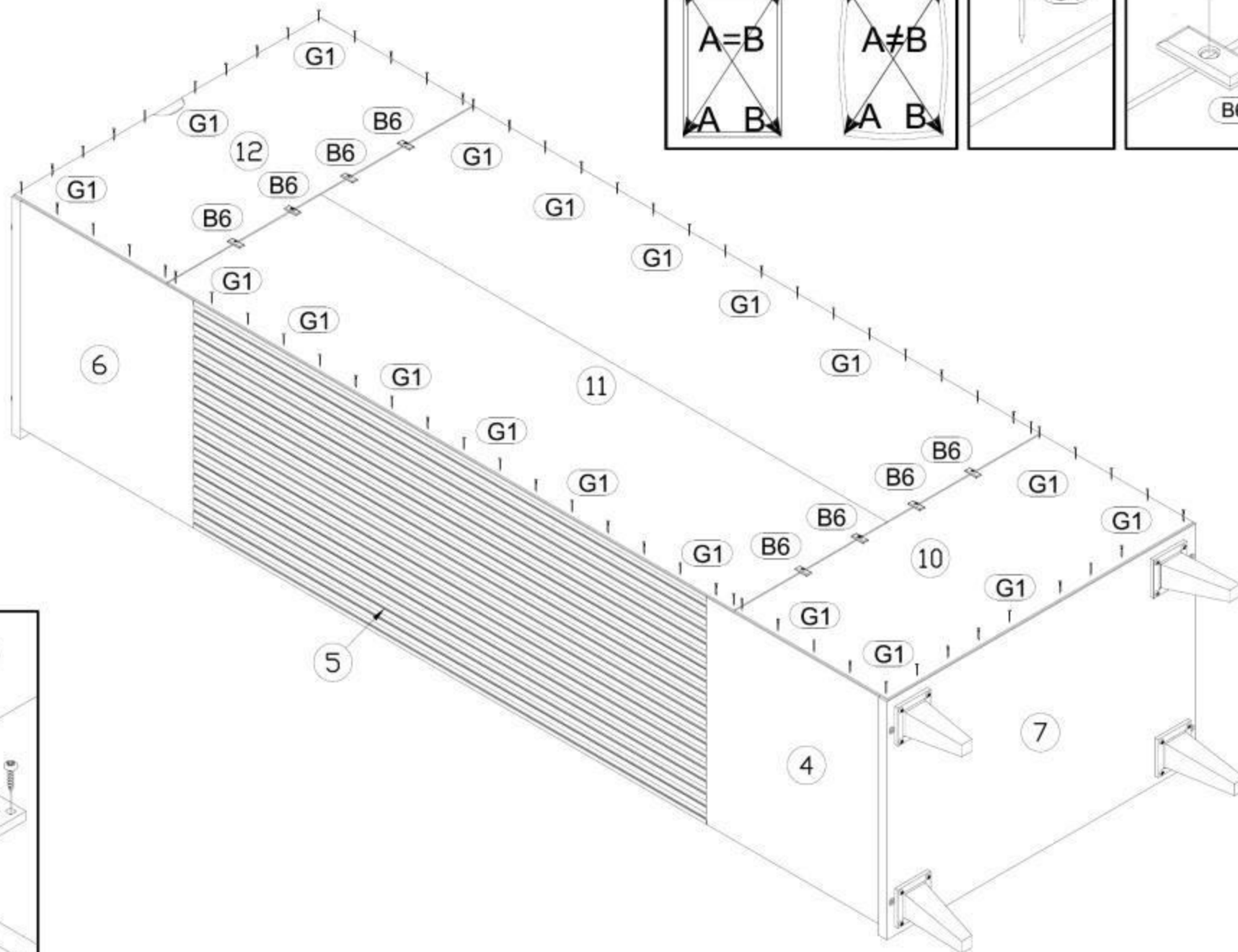
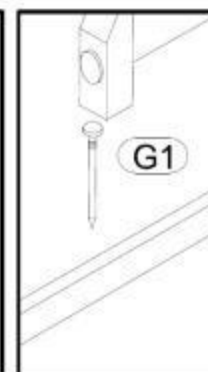
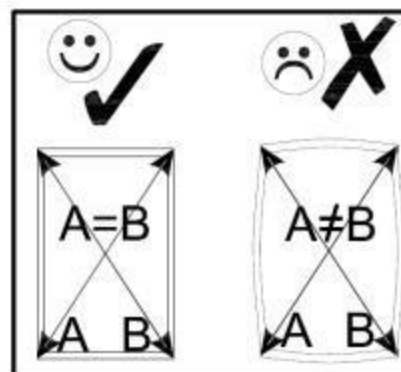
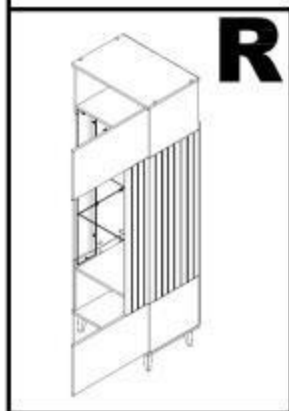



**7**

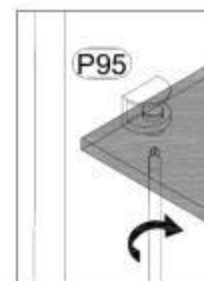
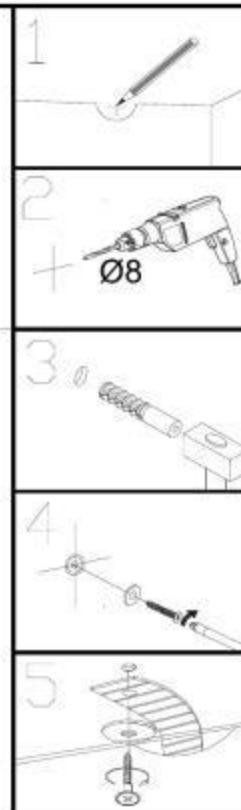
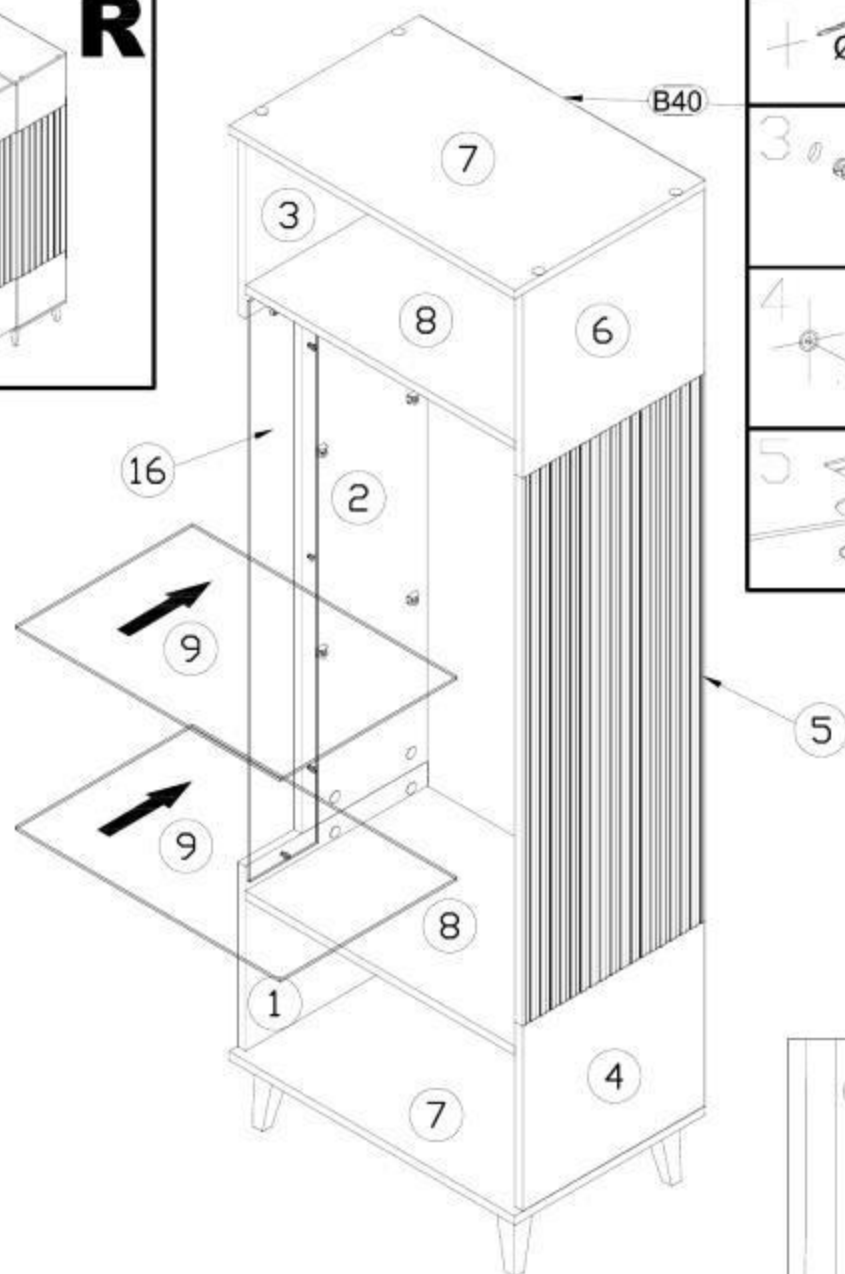
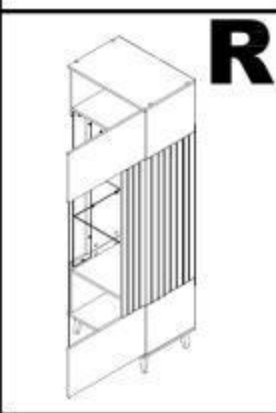
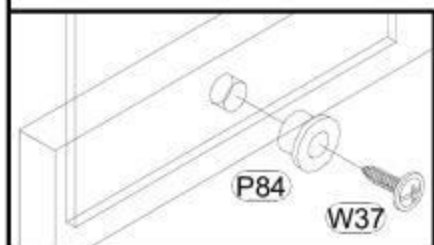
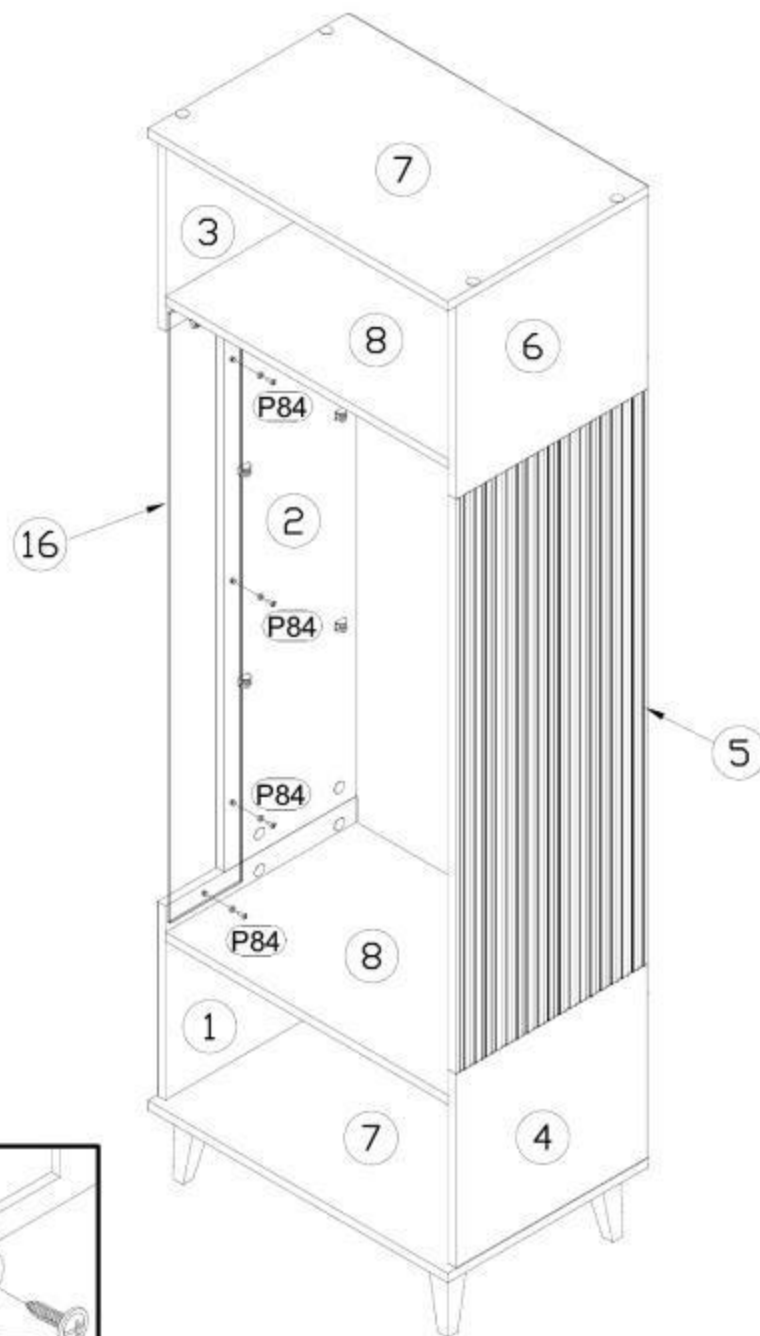
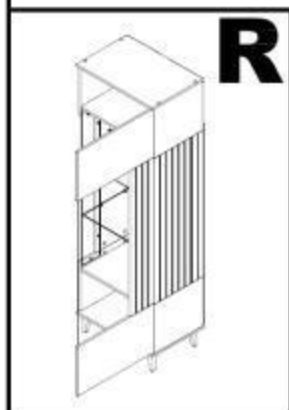

**9**

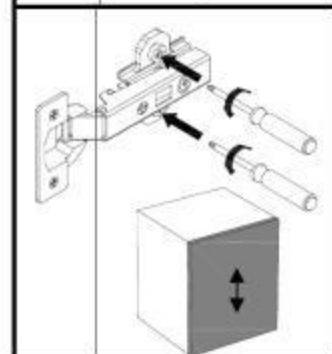
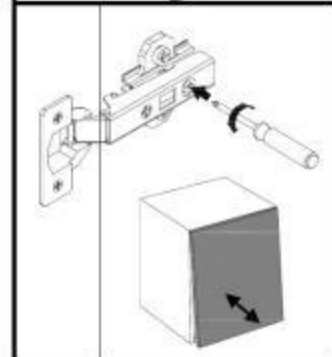
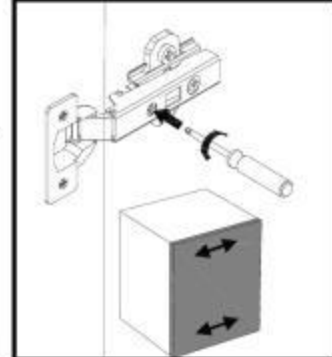
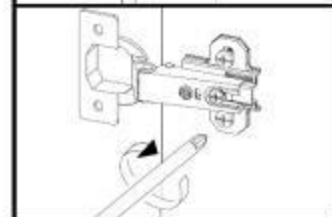
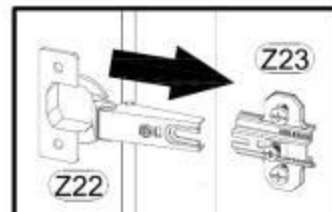
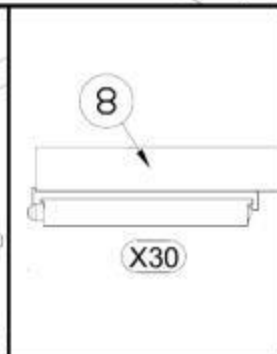
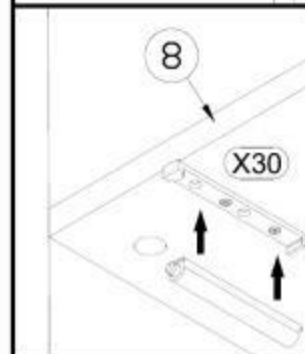
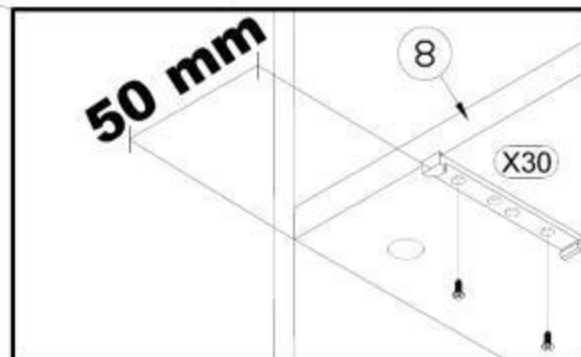
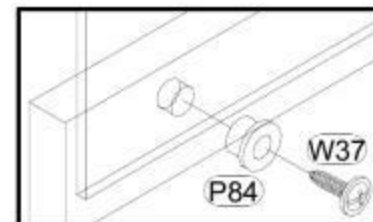
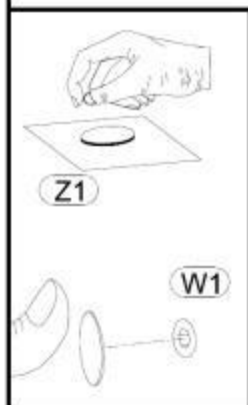
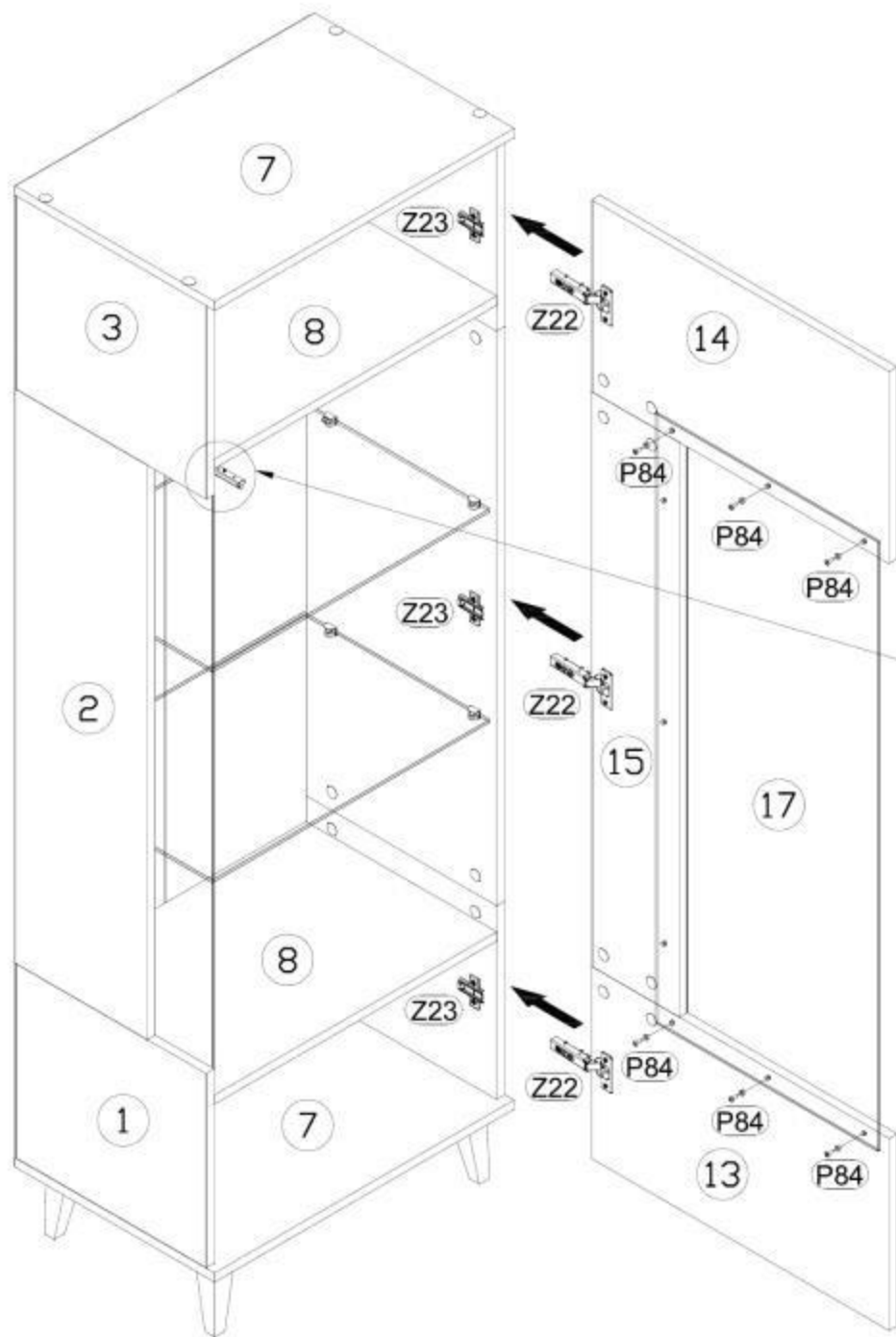
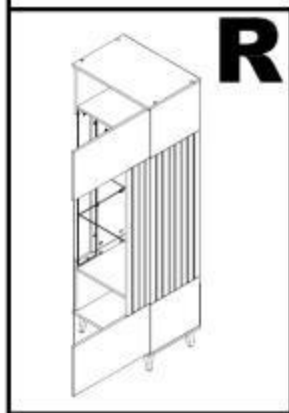

# 10

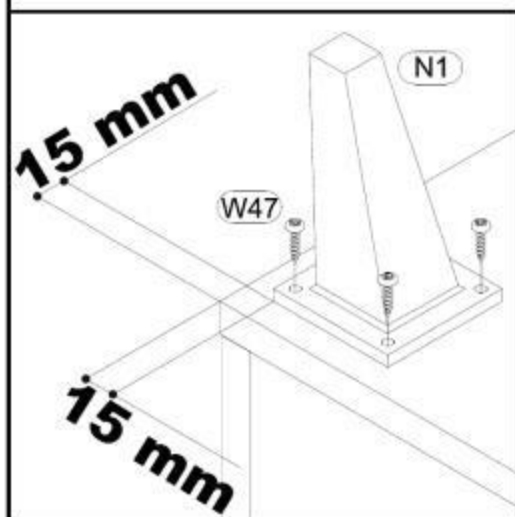
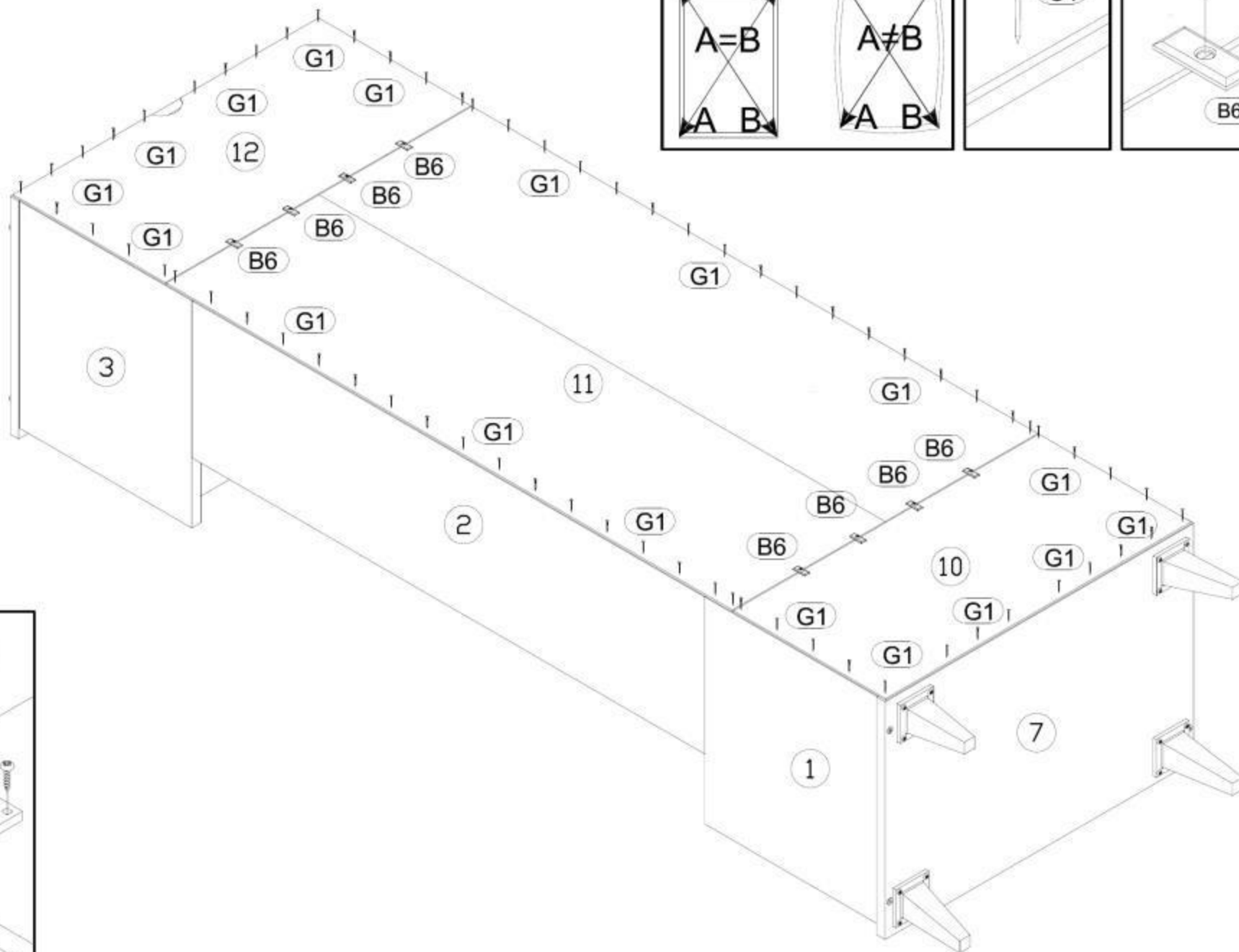
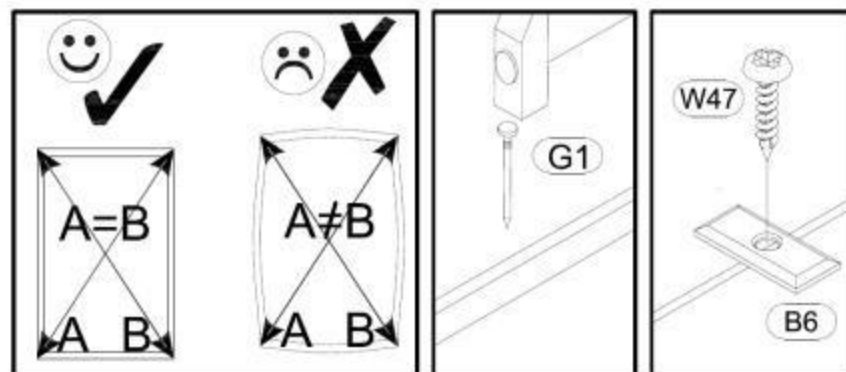
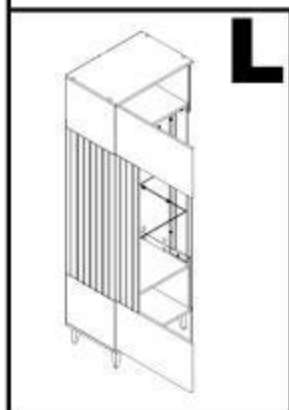

**11**

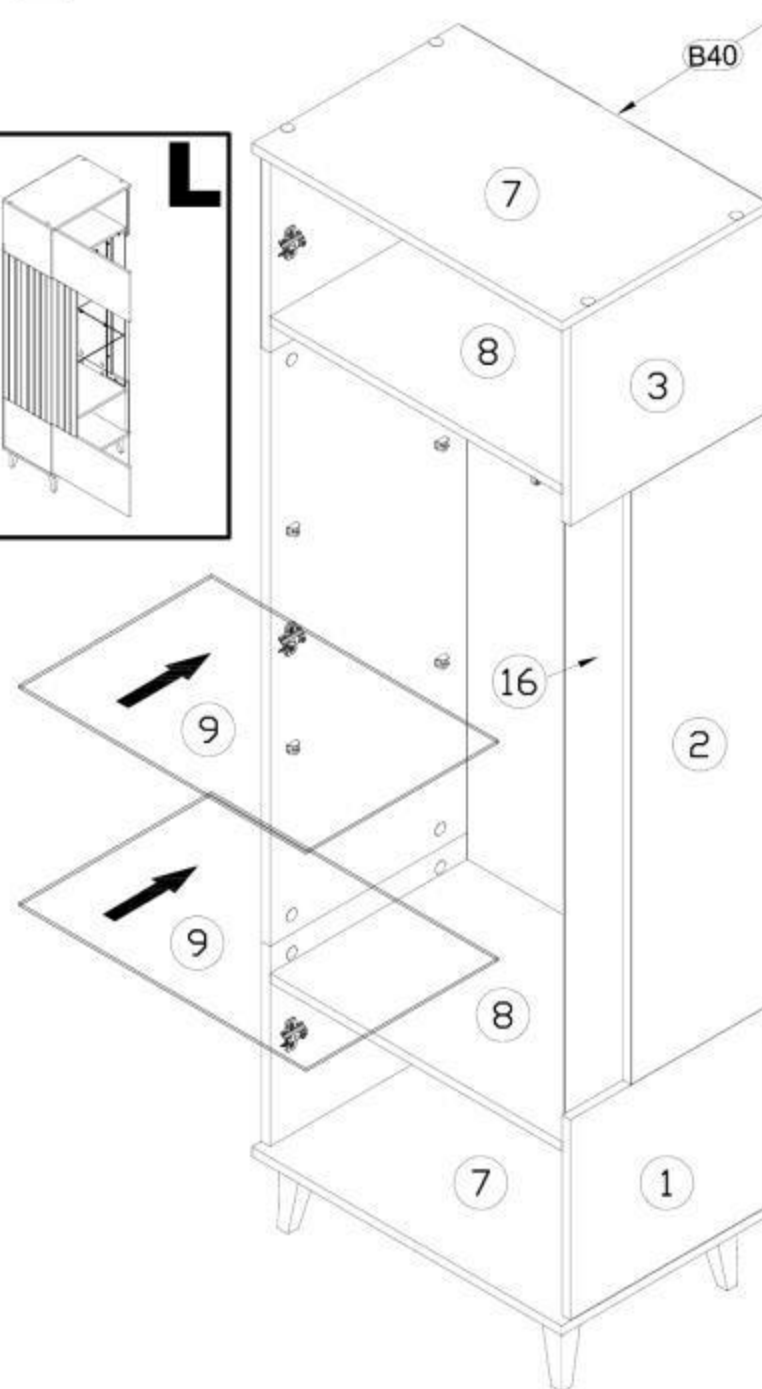
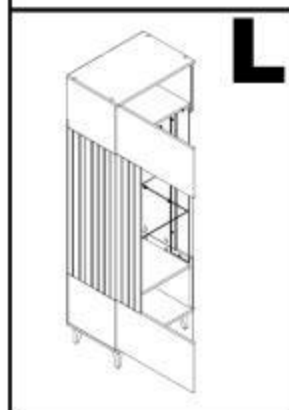
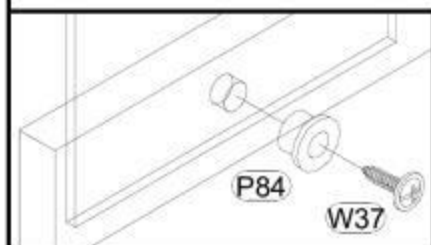
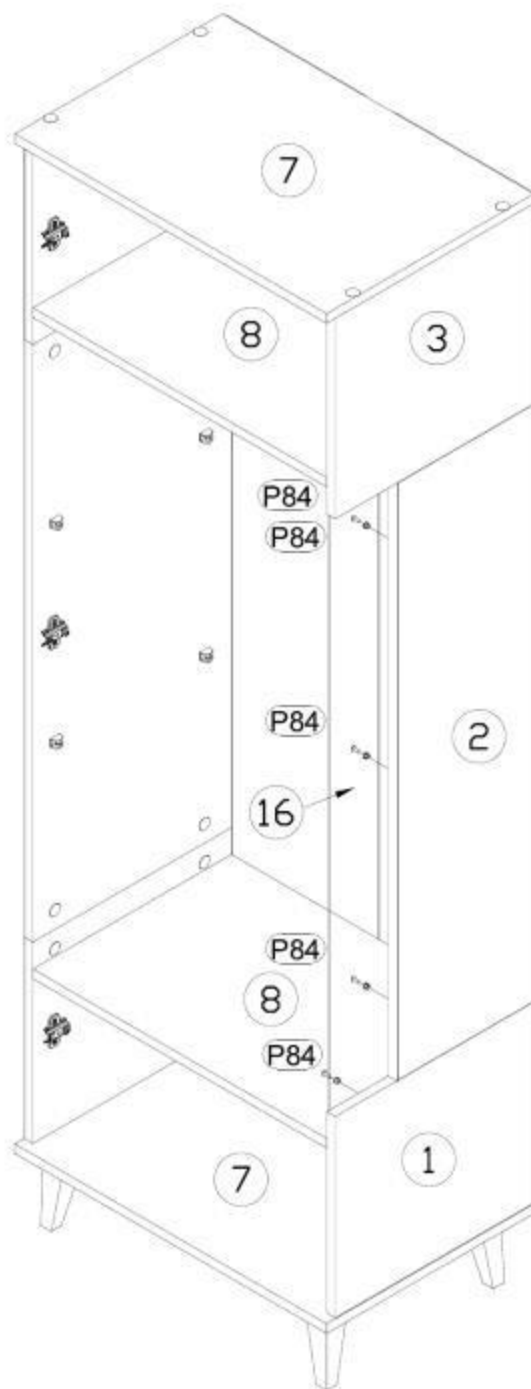
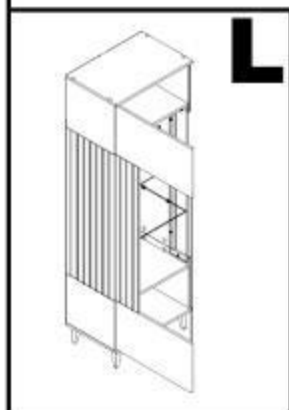

- 1
- 2
- 3
- 4
- 5

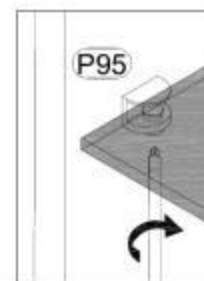

# 13

