

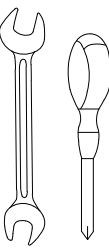

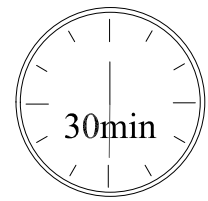

RIVA

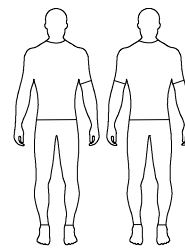
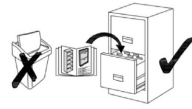
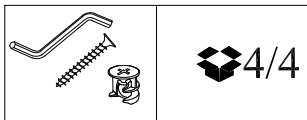
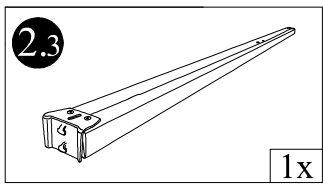
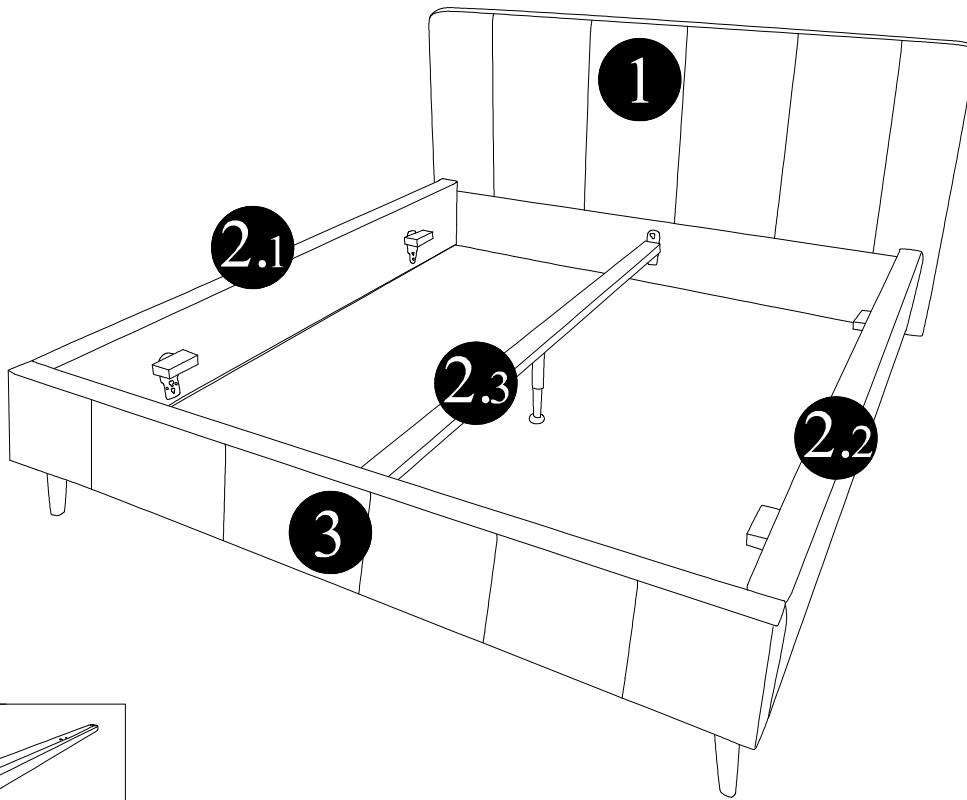
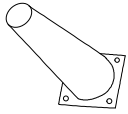
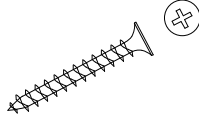
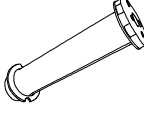

Teil	L	W	H	Pcs	Colli
1	95	160/180/200	13	1x	1/4
2.1 2.2 2.3	27	203	36	3x	2/4
3	16	158/178/198	36	1x	3/4

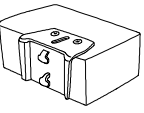



A  H-140 4x	B  3,5x35 18x	C  H-150 1x	D  H-140 2x	E  6x
F  4x				

D		E	
H-140		2x	

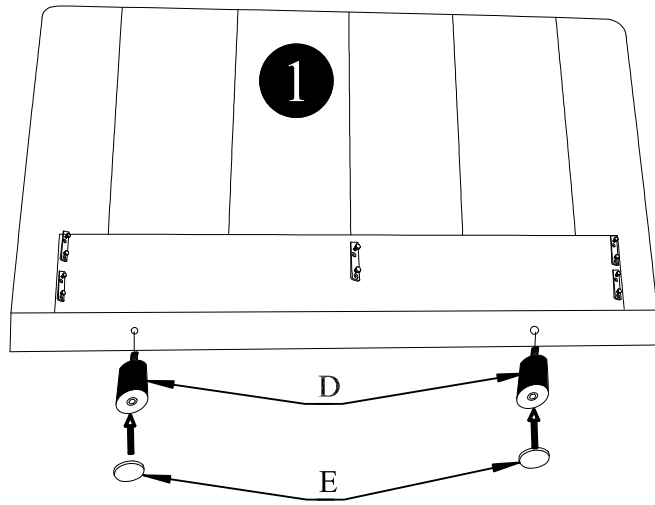

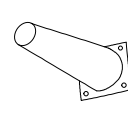
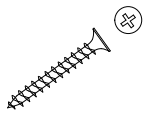
1



A		B		E	
H-140		3,5/35		2x	

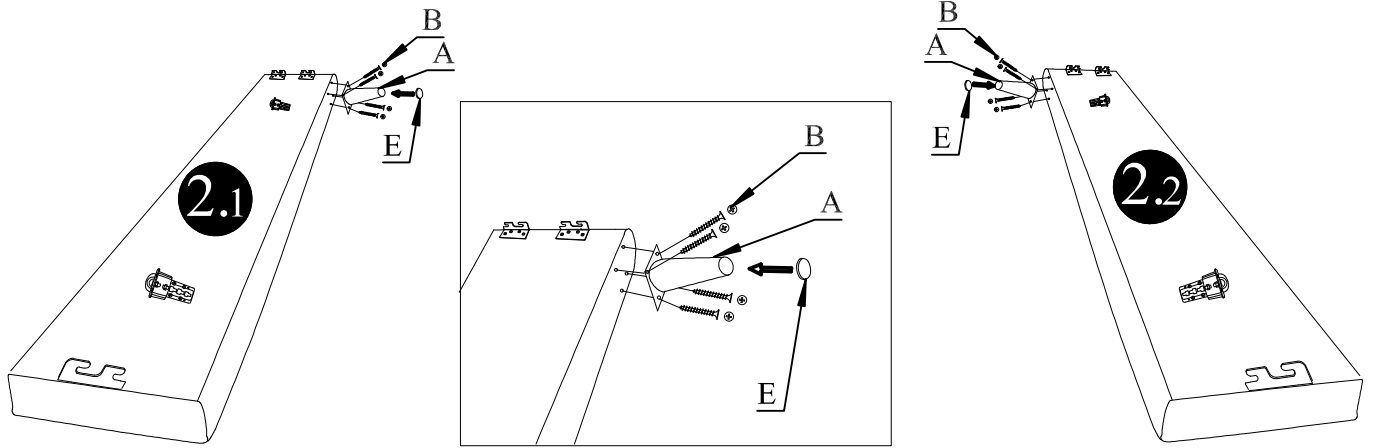

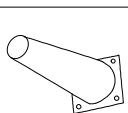
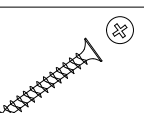
2

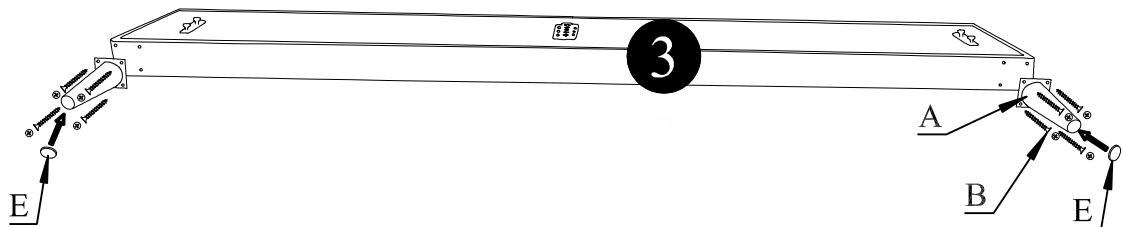

A		B		E	
H-140		3,5/35		2x	

3

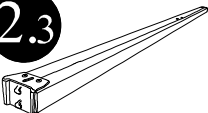
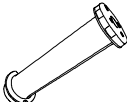

2.3 	C 	B 		
	1x	H-150	1x	3,5/35

4

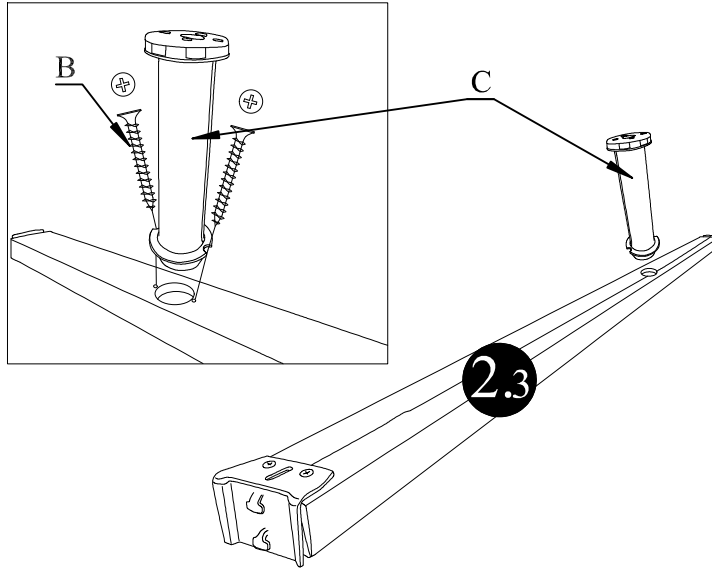

5

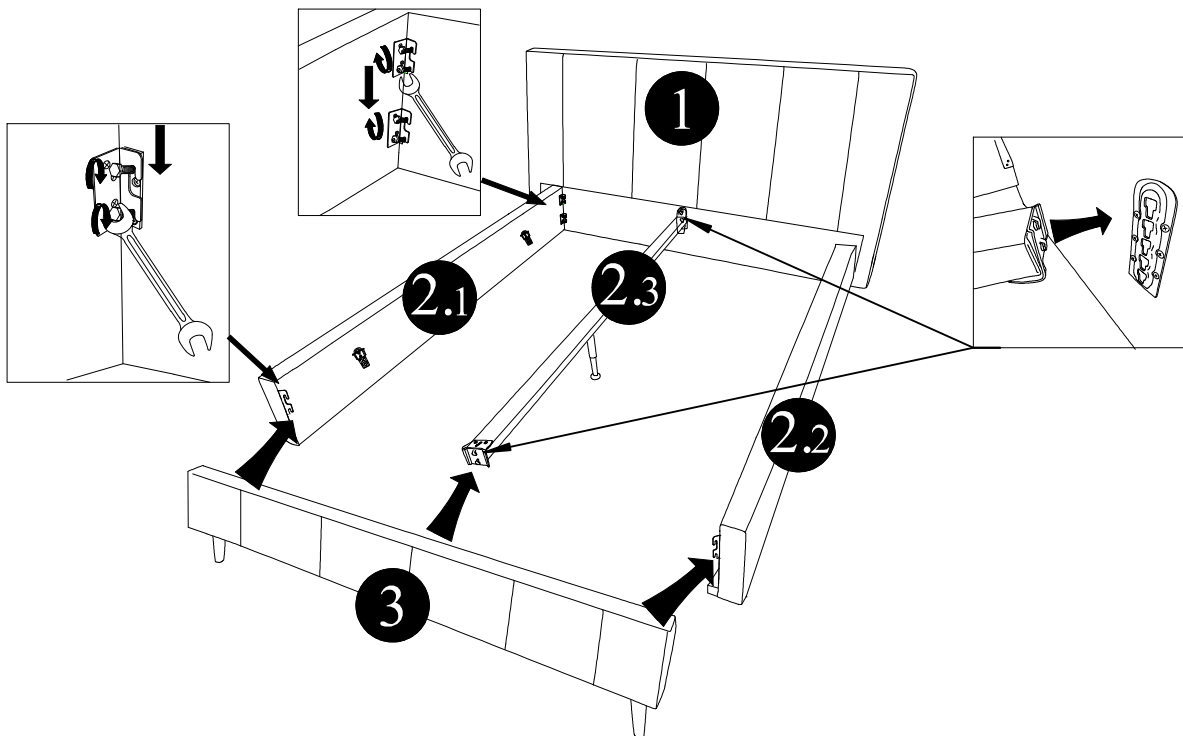

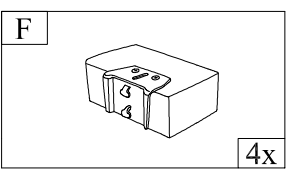

6

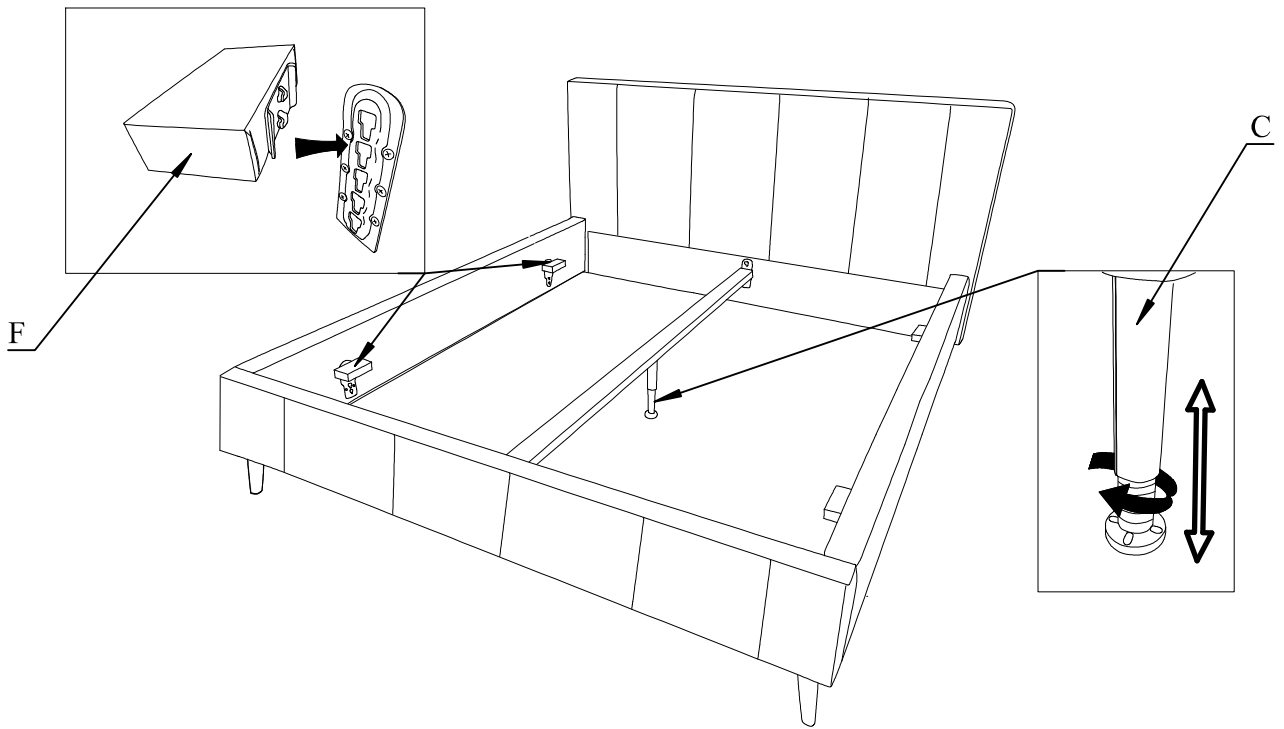

7

