

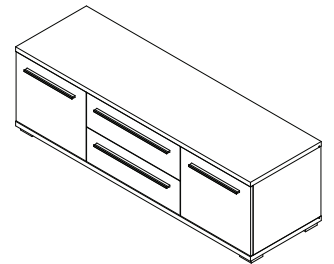

IMPORTANT – READ CAREFULLY – RETAIN FOR FUTURE REFERENCE
WICHTIG – SORGFÄLTIG LESEN UND AUFBEWAHREN

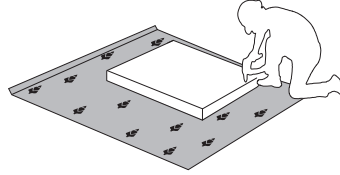

TV150-2K2F/PN
LWH - 1499x452x462
41731

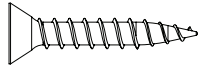
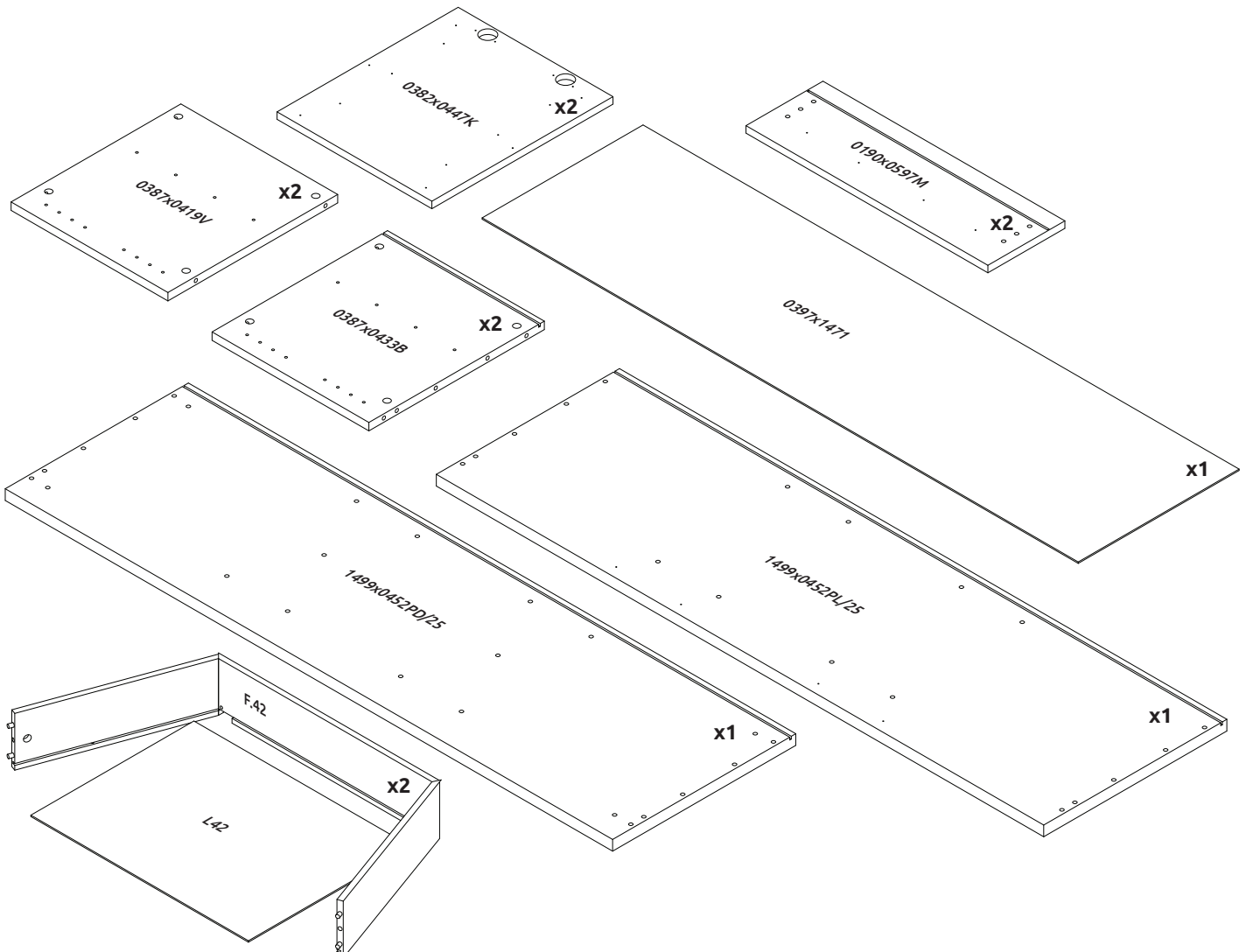
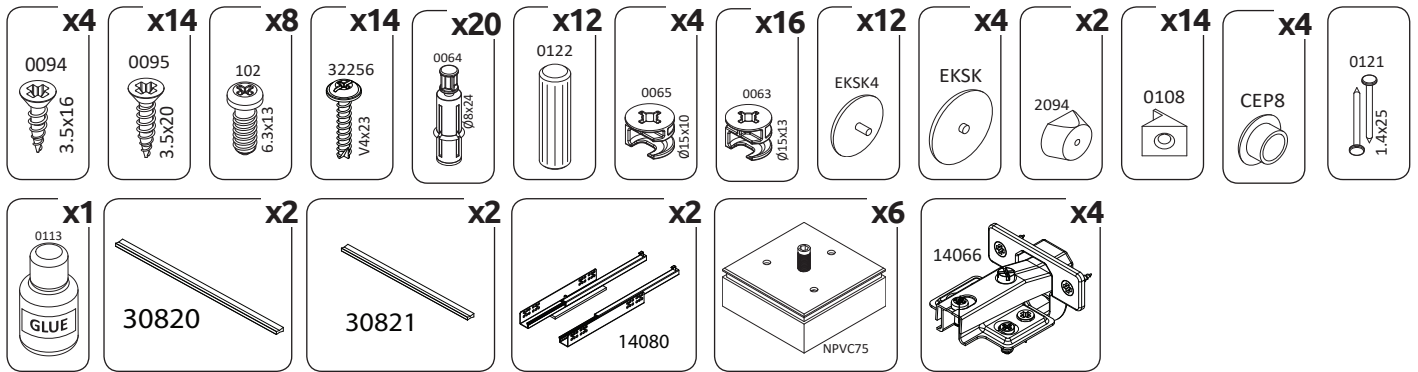

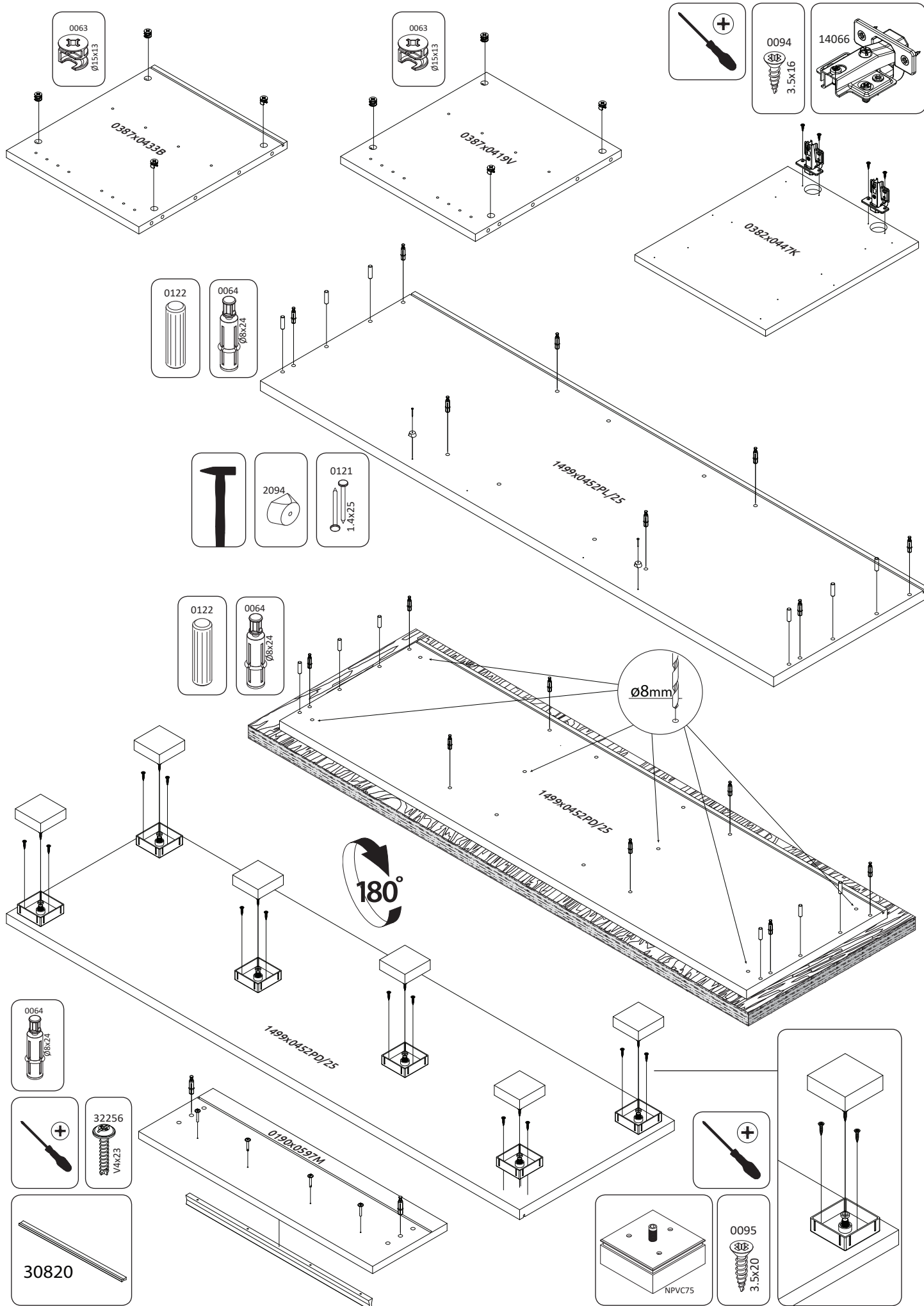

1

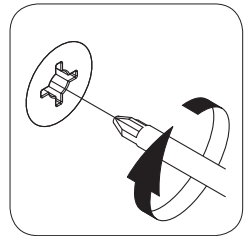
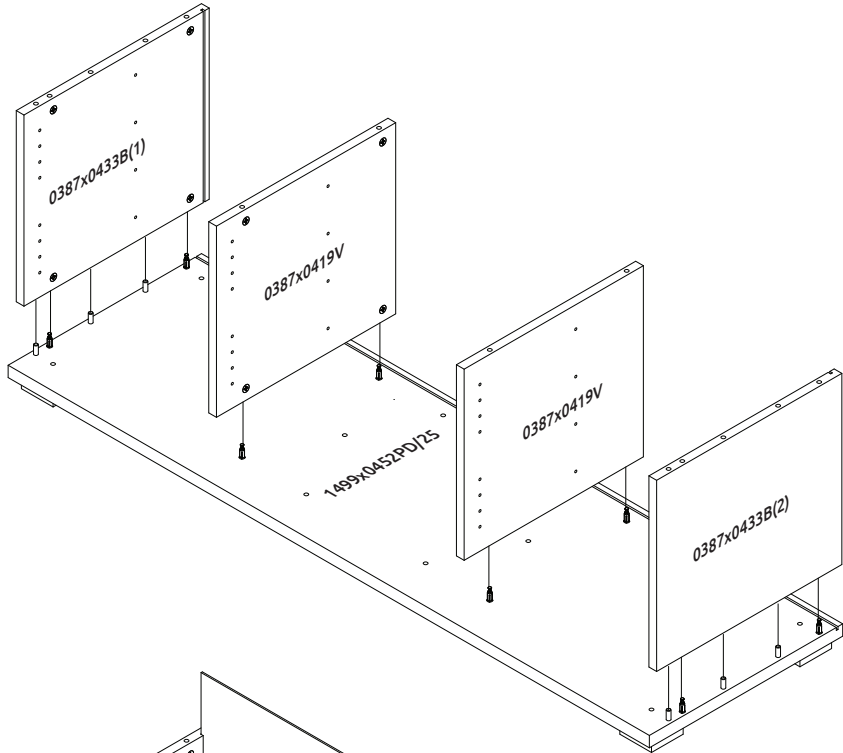

2

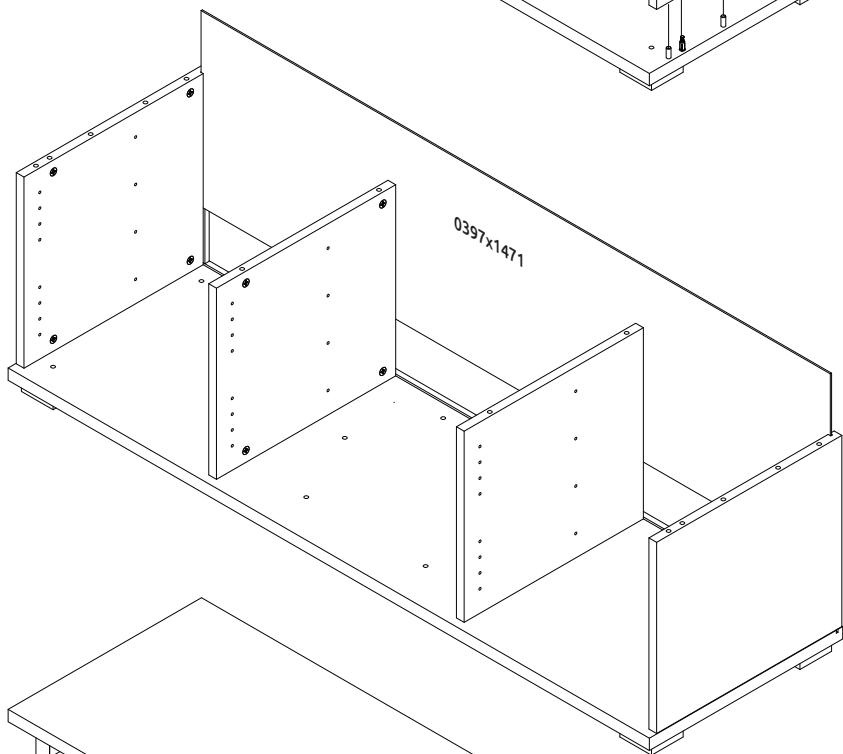

3

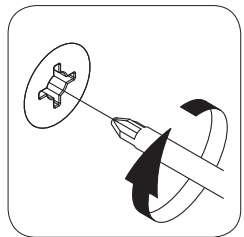
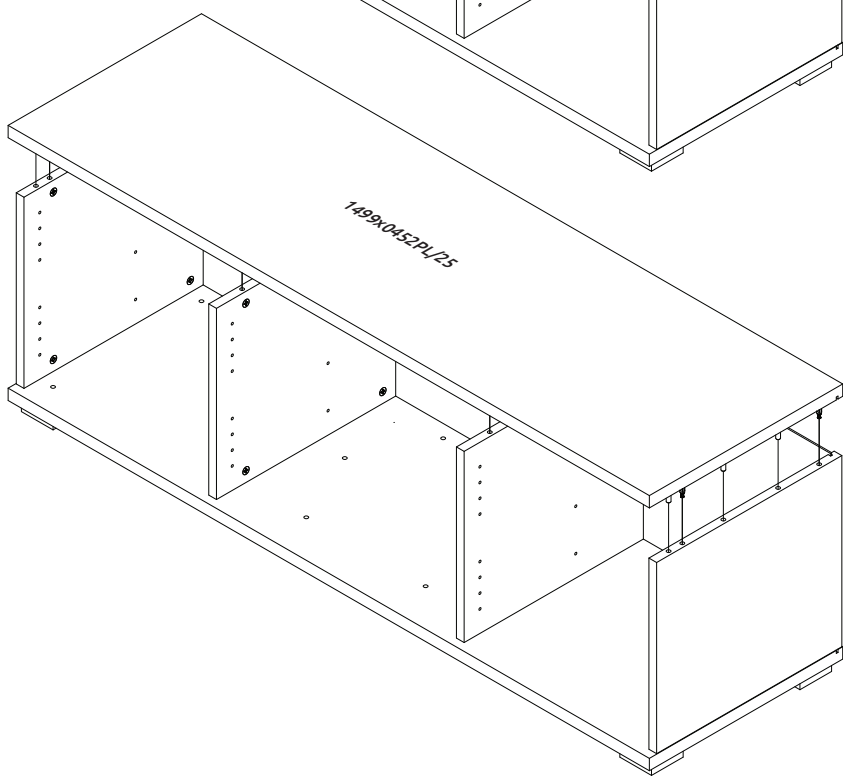

4

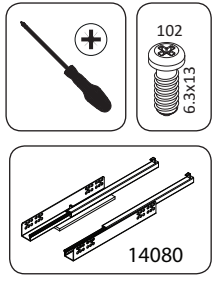
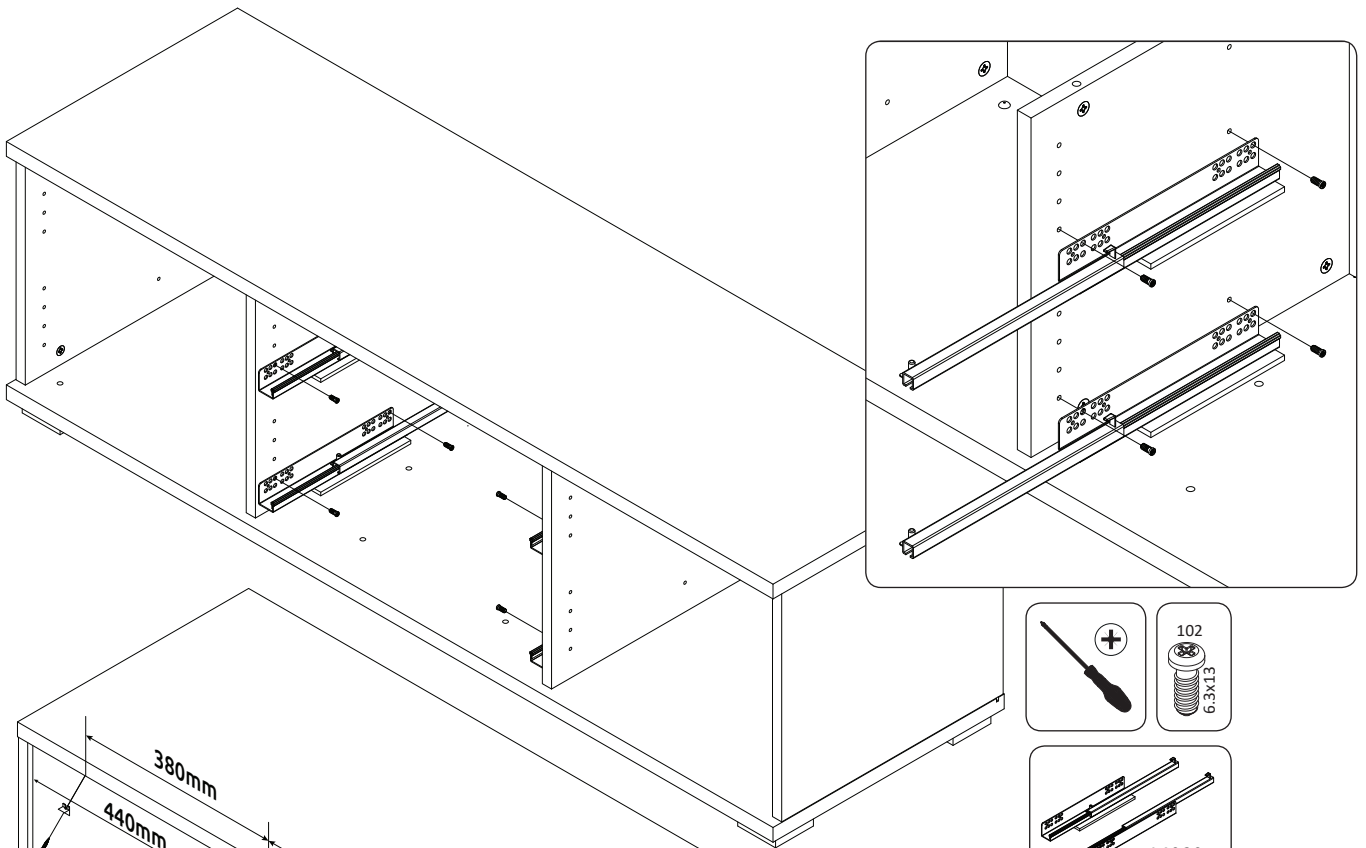

5

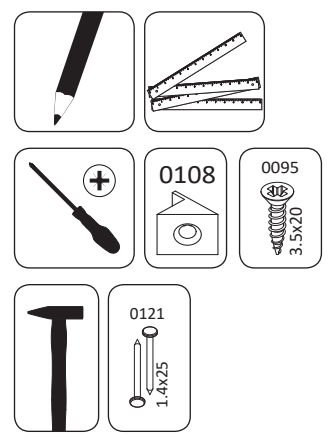
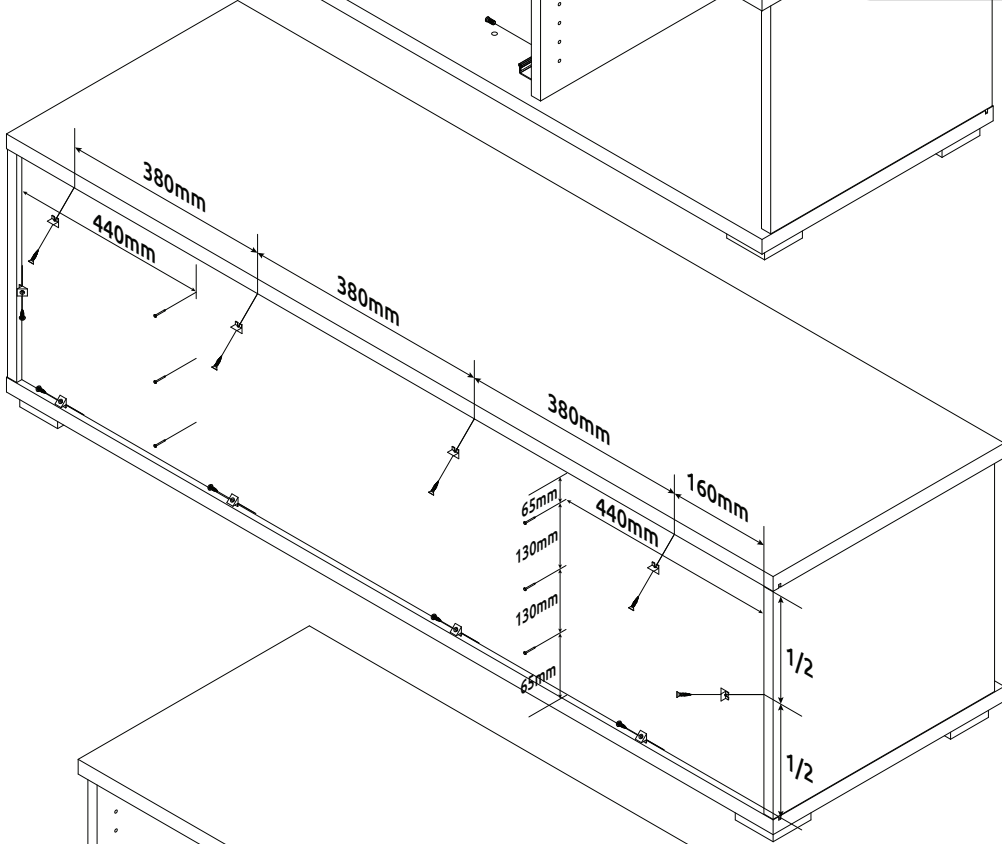

6

