

20.01.1702.00

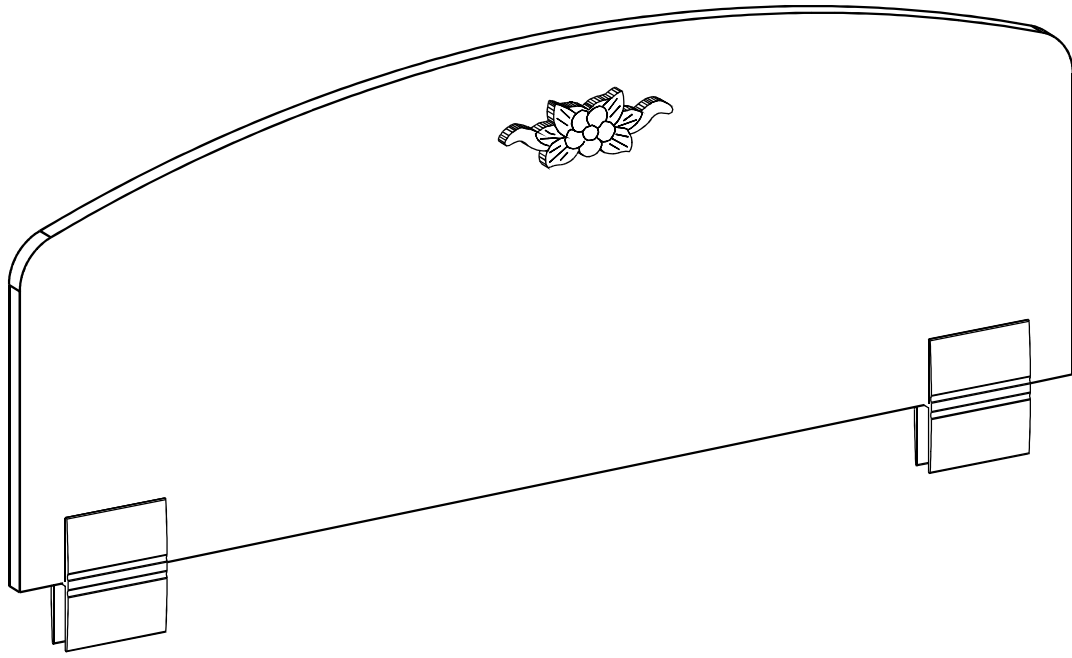

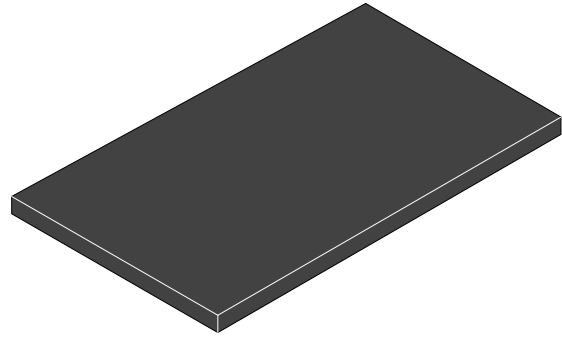
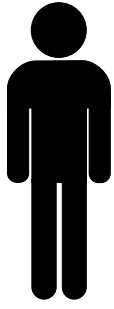

1 / 1

1 / 1

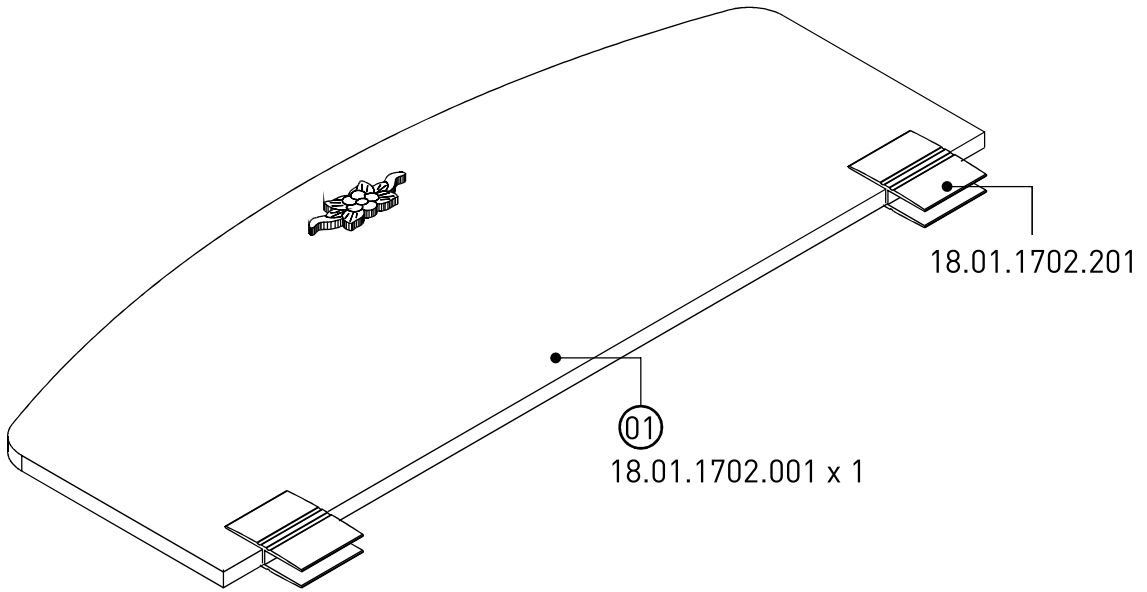

1

