

1

384
480
576



1 2

784
976
1168

1 2 3

784	384
976	480
1168	576

1 2 3 4

784	784
976	976
1168	1168

1 2 3 4 5

784	384	784
976	480	976
1168	576	1168

1 2 3 4 5 6

784	784	784
976	976	976
1168	1168	1168

1 2 3 4 5 6 7

784	784	384	784
976	976	480	976
1168	1168	576	1168

1 2 3 4 5 6 7 8

784	784	784	784
976	976	976	976
1168	1168	1168	1168

1.

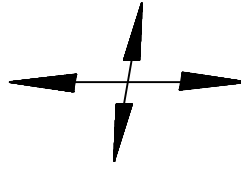

1

641.0227.000
12 mm



2

1

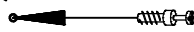
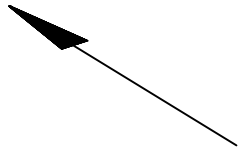

2

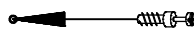

2

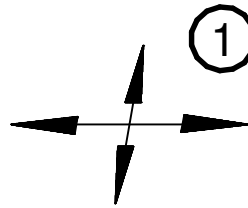
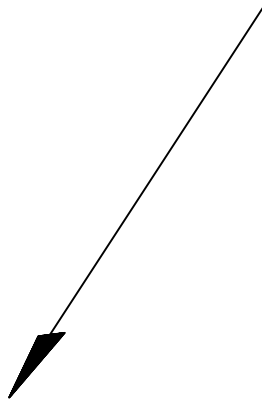

1

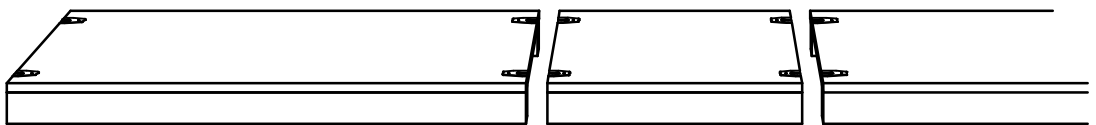

2.

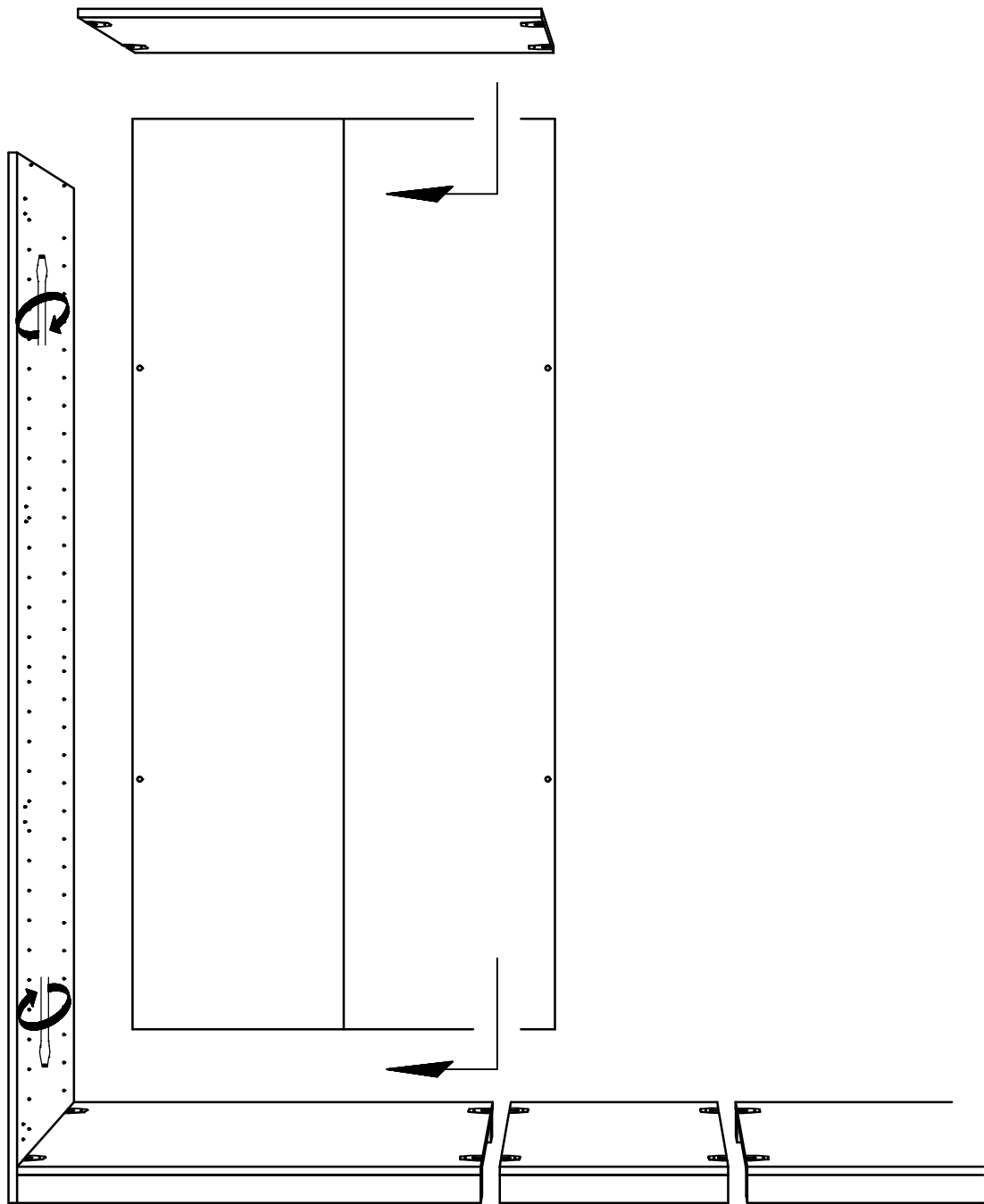

621.2930.000

631.1266.000

6,3 x 11 mm

631.1472.000

3,5 x 15 mm

641.0226.000

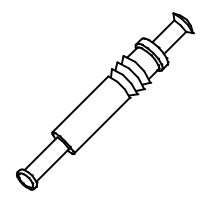
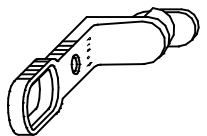

3

4

5

6

3.

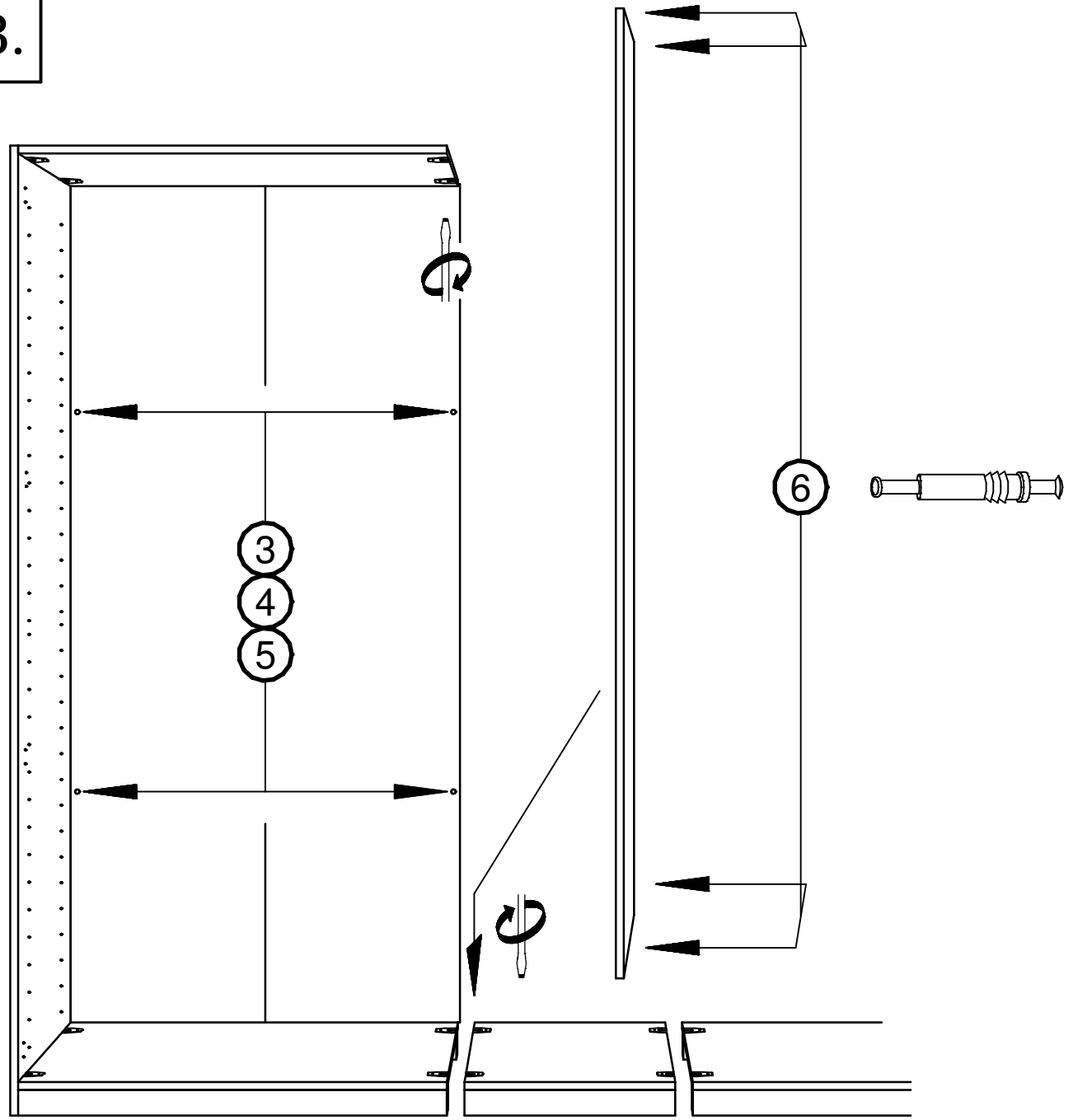

3

5

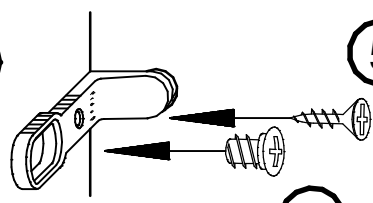

4

641.0204.000

632.0038.000

4 x 14 mm

621.0067.000

632.0517.000

M6 x 30 mm

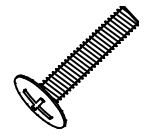
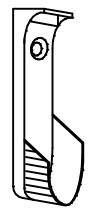
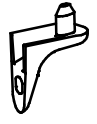

7

8

9

10

4.

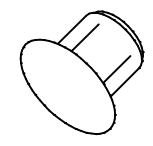

11

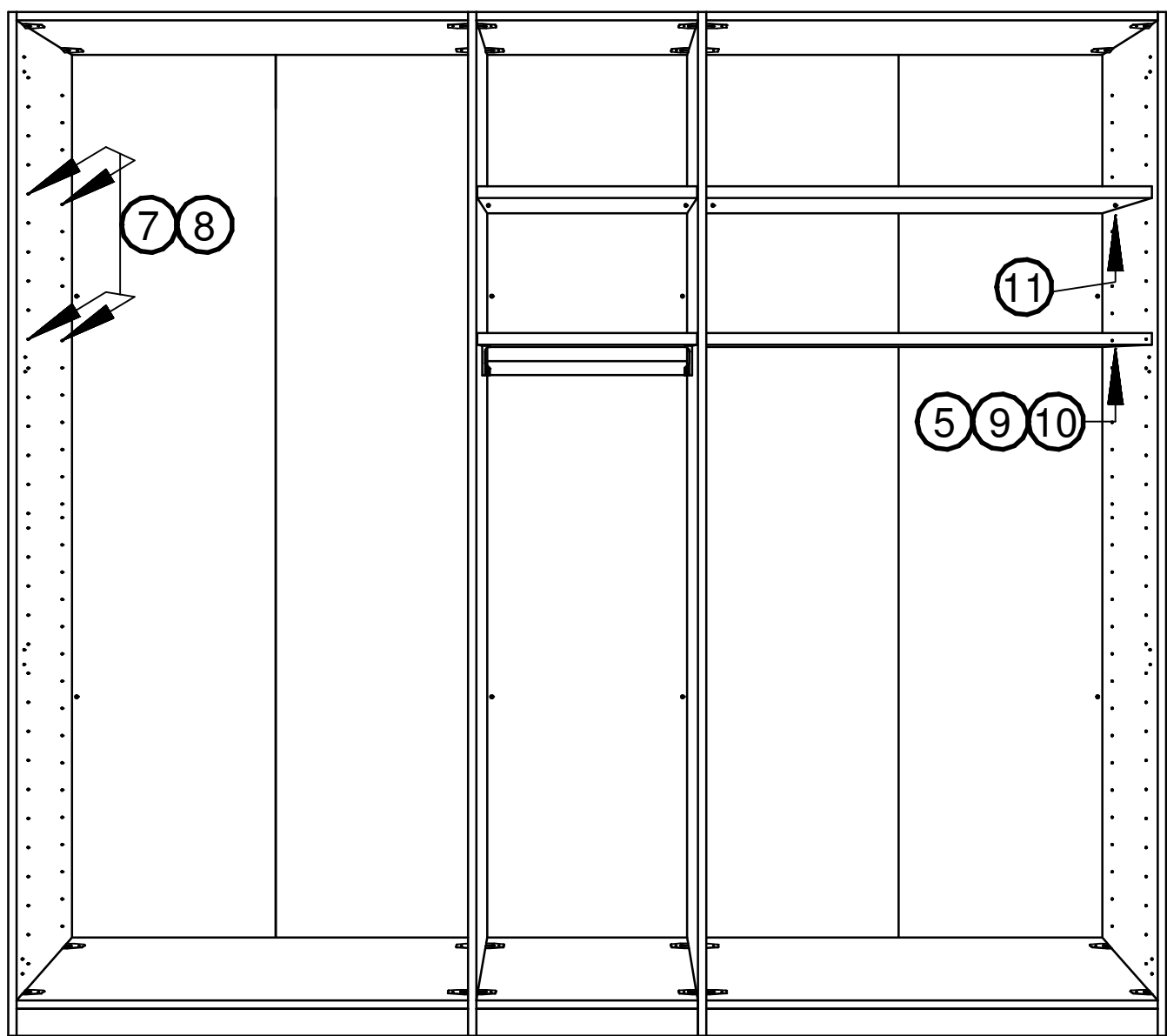

5.

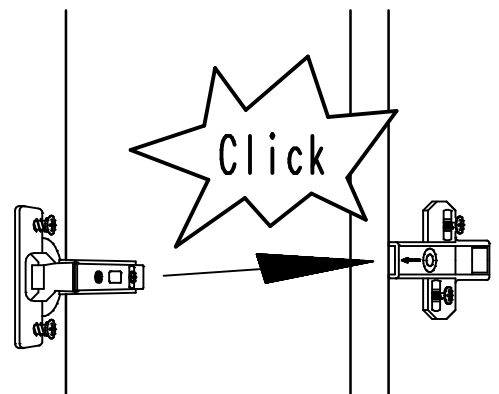
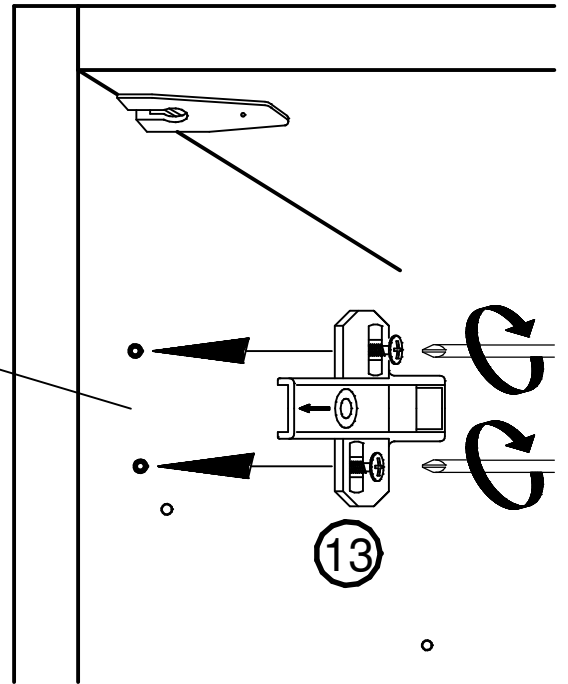
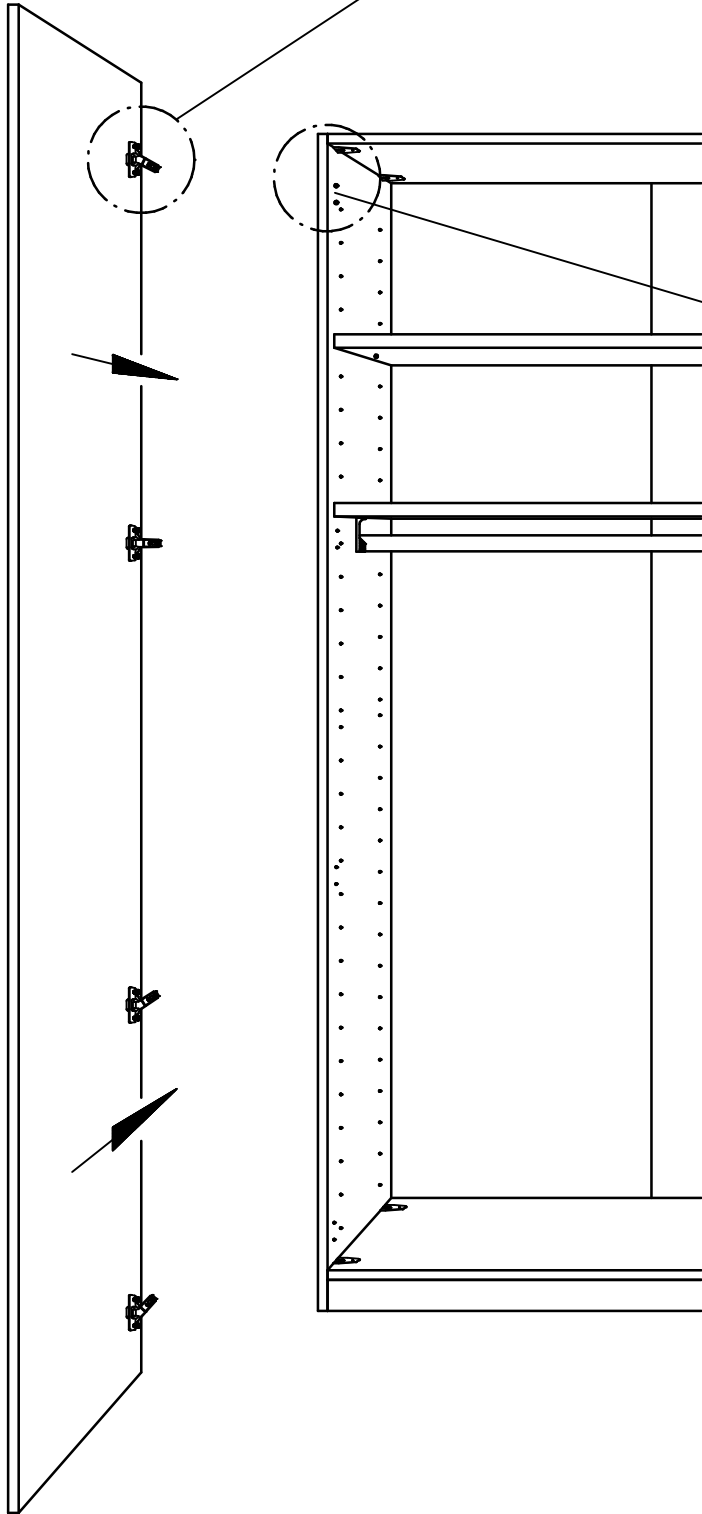
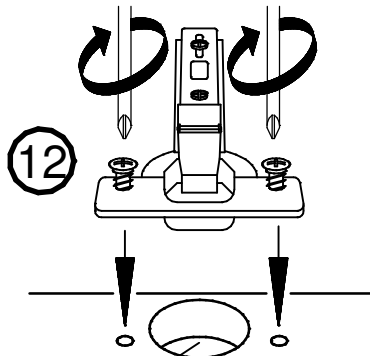
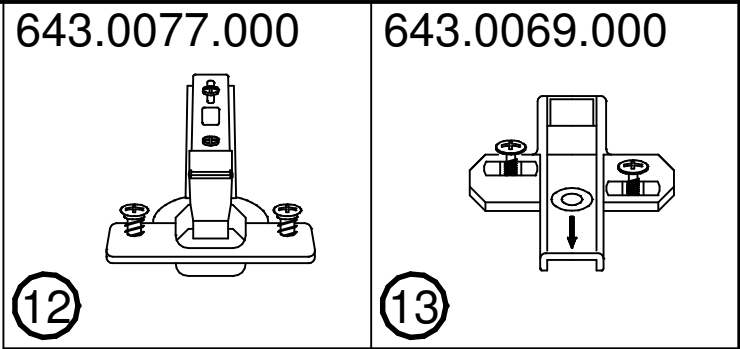

6.

OPTION

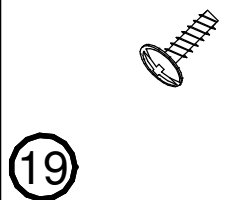
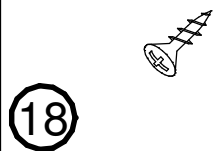
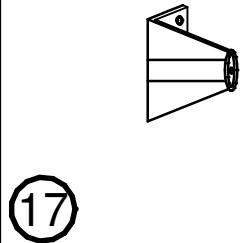
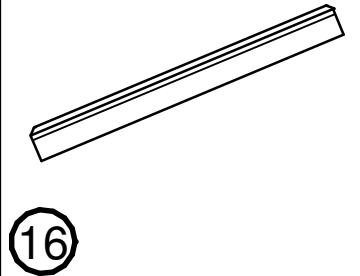
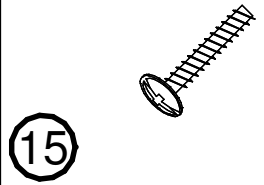
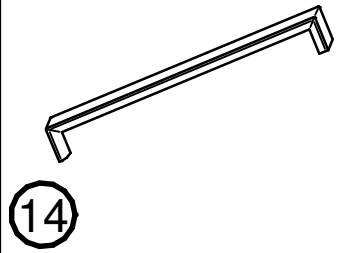
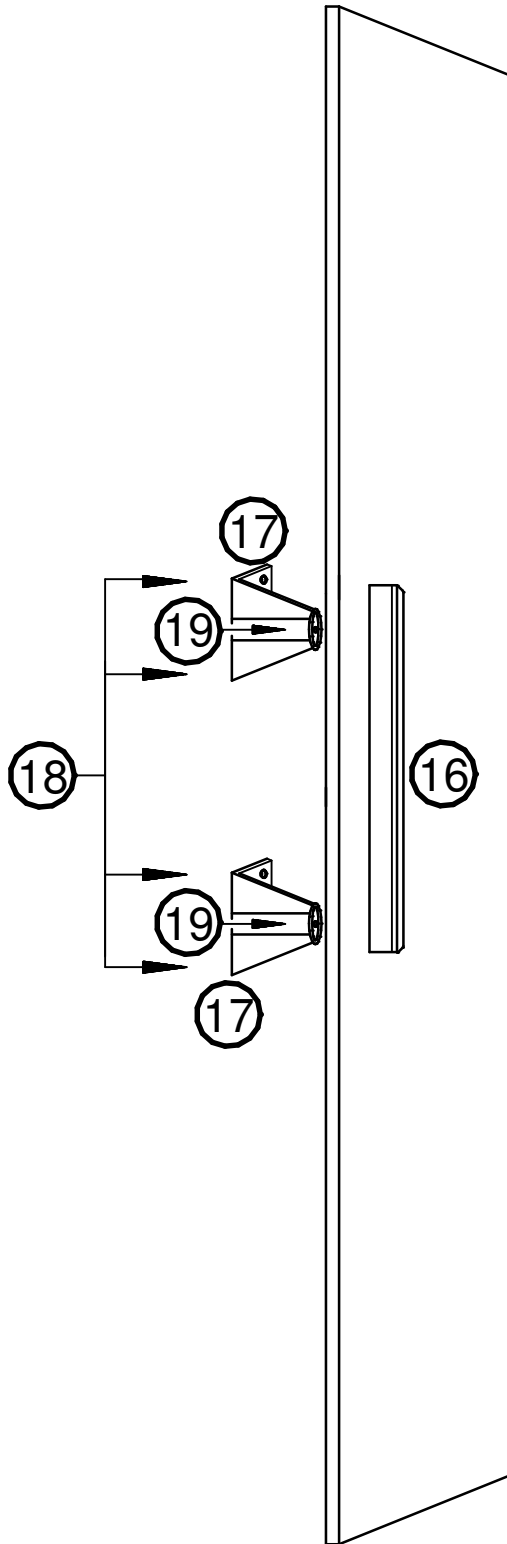
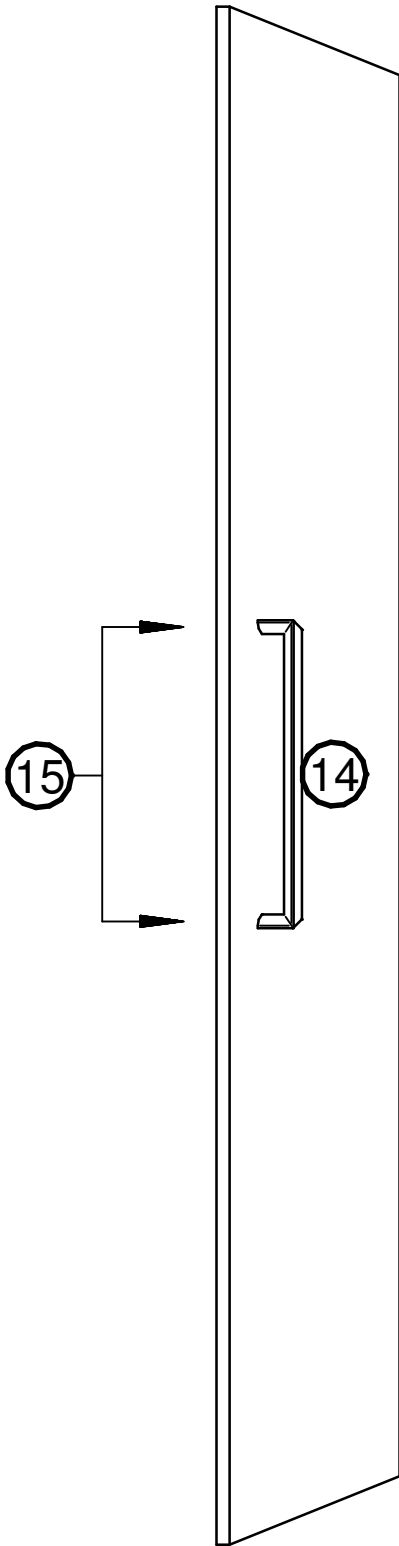

7.

OPTION

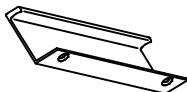
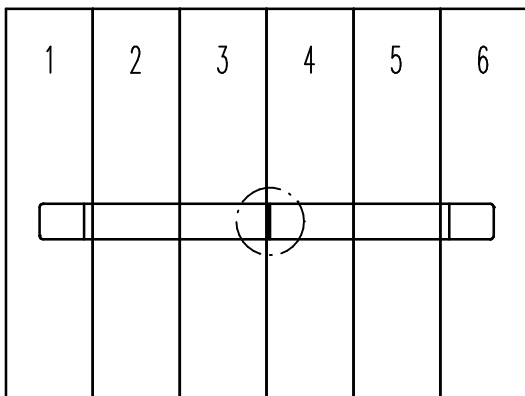
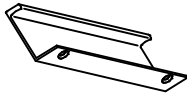
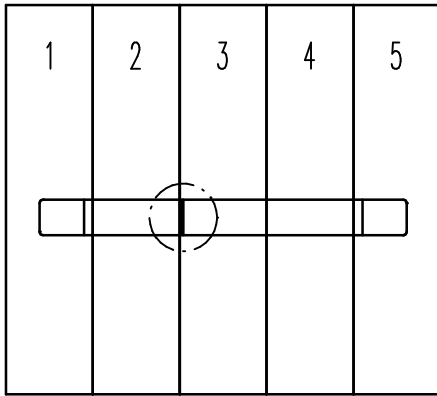
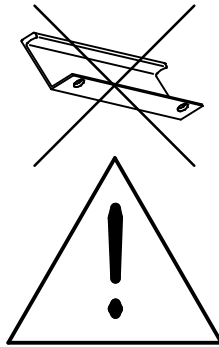
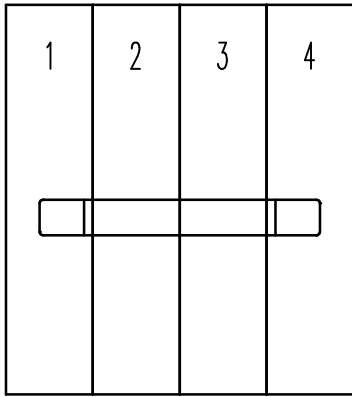

642.0968...

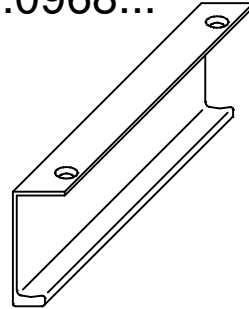

20

631.1473.000
3,5 x 15 mm



5

2 x

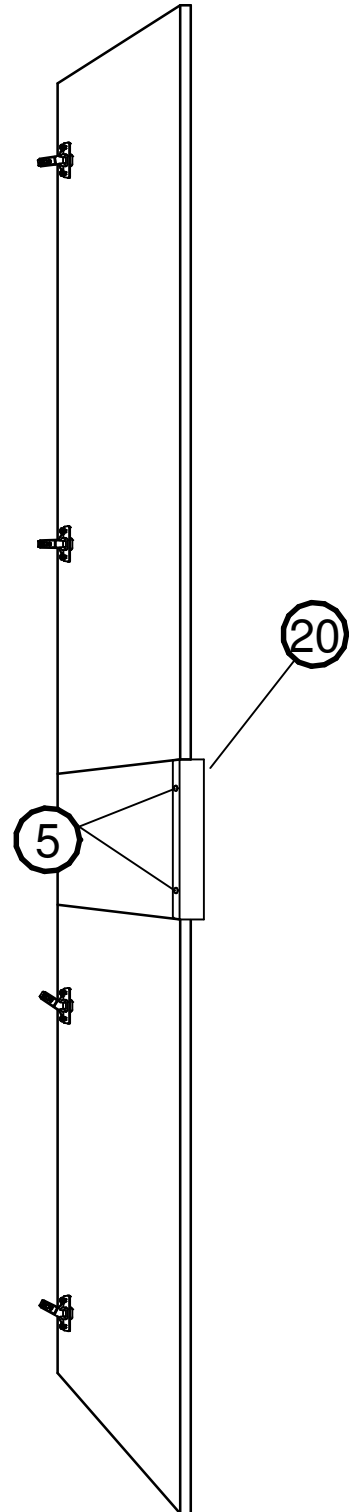

8.

OPTION

642.0999.005

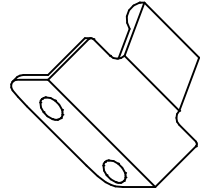

(21)

631.1099.000

4 x 15 mm



(22)

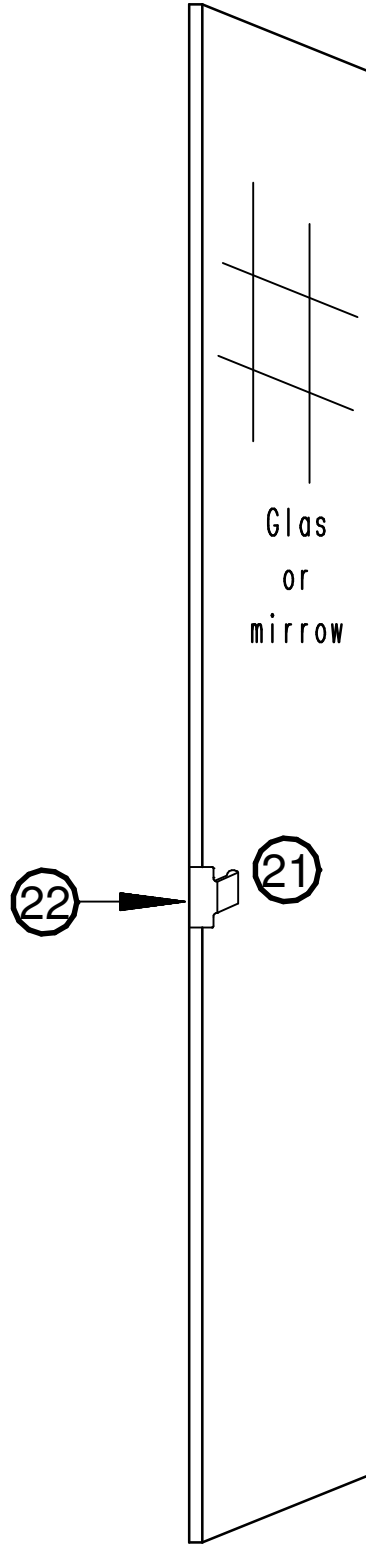

9.

